

FDP8440

N-Channel PowerTrench® MOSFET

40 V, 277 A, 2.2 mΩ

Features

- $R_{DS(on)} = 1.64 \text{ m}\Omega$ (Typ.) @ $V_{GS} = 10 \text{ V}$, $I_D = 80 \text{ A}$
- $Q_{g(tot)} = 345 \text{ nC}$ (Typ.) @ $V_{GS} = 10 \text{ V}$
- Low Miller Charge
- Low Q_{rr} Body Diode
- UIS Capability (Single Pulse and Repetitive Pulse)
- RoHS Compliant

Applications

- Power Tools
- Motor Drives and Uninterruptible Power Supplies
- Synchronous Rectification
- Battery Protection Circuit

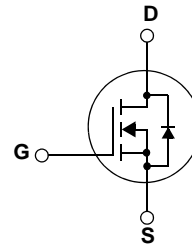
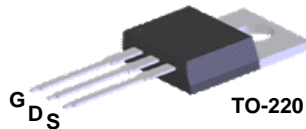

MOSFET Maximum Ratings $T_C = 25^\circ\text{C}$ unless otherwise noted

Symbol	Parameter		FDP8440	Unit
V_{DSS}	Drain to Source Voltage		40	V
V_{GSS}	Gate to Source Voltage		± 20	V
I_D	Drain Current	- Continuous ($T_C = 25^\circ\text{C}$, Silicon Limited) - Continuous ($T_C = 100^\circ\text{C}$, Silicon Limited) - Continuous ($T_C = 25^\circ\text{C}$, Package Limited)	277* 196* 100	A
I_{DM}	Drain Current	- Pulsed (Note 1)	500	A
E_{AS}	Single Pulsed Avalanche Energy (Note 2)		1682	mJ
P_D	Power Dissipation	($T_C = 25^\circ\text{C}$) - Derate above 25°C	306 2.04	W W/ $^\circ\text{C}$
T_J, T_{STG}	Operating and Storage Temperature Range		-55 to +175	$^\circ\text{C}$
T_L	Maximum Lead Temperature for Soldering Purpose, 1/8" from Case for 5 Seconds		300	$^\circ\text{C}$

*Calculated continuous current based on maximum allowable junction temperature. Package limitation current is 100A.

Thermal Characteristics

$R_{\theta JC}$	Thermal Resistance, Junction to Case, Max.	0.49	$^\circ\text{C}/\text{W}$
$R_{\theta CS}$	Thermal Resistance, Case to Sink (Typ.)	0.5	$^\circ\text{C}/\text{W}$
$R_{\theta JA}$	Thermal Resistance, Junction to Ambient, Max.	62.5	$^\circ\text{C}/\text{W}$

Package Marking and Ordering Information

Device Marking	Device	Package	Reel Size	Tape Width	Quantity
FDP8440	FDP8440	TO-220	N/A	N/A	50units

Electrical Characteristics T_C = 25°C unless otherwise noted

Symbol	Parameter	Conditions	Min	Typ	Max	Unit	
Off Characteristics							
BV _{DSS}	Drain to Source Breakdown Voltage	V _{GS} = 0V, I _D = 250μA	40	--	--	V	
I _{DSS}	Zero Gate Voltage Drain Current	V _{DS} = 32V	--	--	1	μA	
I _{GSS}		V _{GS} = 0V, T _C = 150°C	--	--	250	μA	
I _{GSS}	Gate to Body Leakage Current	V _{GS} = ±20V	--	--	±100	nA	
On Characteristics							
V _{GS(th)}	Gate to Source Threshold Voltage	V _{DS} = V _{GS} , I _D = 250μA	1	--	3	V	
R _{DS(on)}	Static Drain-Source On-Resistance	V _{GS} = 4.5V, I _D = 80A	--	1.88	2.4	mΩ	
		V _{GS} = 10V, I _D = 80A	--	1.64	2.2		
		V _{GS} = 10V, I _D = 80A, T _C = 175°C	--	3.00	4.4		
Dynamic Characteristics							
C _{iss}	Input Capacitance	V _{DS} = 25V, V _{GS} = 0V, f = 1.0MHz	--	18600	24740	pF	
C _{oss}	Output Capacitance		--	1840	2450	pF	
C _{rss}	Reverse Transfer Capacitance		--	1400	2100	pF	
R _G	Gate Resistance	V _{GS} = 0.5V, f = 1MHz	--	1.1	--	Ω	
Q _{g(tot)}	Total Gate Charge at 10V	V _{GS} = 0V to 10V	V _{DD} = 20V I _D = 80A I _g = 1.0mA	--	345	450	nC
Q _{g(2)}	Threshold Gate Charge	V _{GS} = 0V to 2V		--	32.5	--	nC
Q _{gs}	Gate to Source Gate Charge			--	49	--	nC
Q _{gs2}	Gate Charge Threshold to Plateau			--	16.5	--	nC
Q _{gd}	Gate to Drain "Miller" Charge			--	74	--	nC
Switching Characteristics (V_{GS} = 10V)							
t _{ON}	Turn-On Time	V _{DD} = 20V, I _D = 80A V _{GS} = 10V, R _{GEN} = 7Ω	--	175	360	ns	
t _{d(on)}	Turn-On Delay Time		--	43	95	ns	
t _r	Rise Time		--	130	275	ns	
t _{d(off)}	Turn-Off Delay Time		--	435	875	ns	
t _f	Fall Time		--	290	590	ns	
t _{OFF}	Turn-Off Time		--	730	1470	ns	
Drain-Source Diode Characteristics and Maximum Ratings							
V _{SD}	Source to Drain Diode Voltage	I _{SD} = 80A	--	--	1.25	V	
		I _{SD} = 40A	--	--	1.0	V	
t _{rr}	Reverse Recovery Time	I _{SD} = 75A, dI _{SD} /dt = 100A/μs	--	59	--	ns	
Q _{RR}	Reverse Recovery Charge	I _{SD} = 75A, dI _{SD} /dt = 100A/μs	--	77	--	nC	

NOTES:

- 1: Pulse width limited by maximum junction temperature.
- 2: Starting T_J = 25°C, L = 1mH, I_{AS} = 58A, V_{DD} = 36V, V_{GS} = 10V.

Typical Performance Characteristics

Figure 1. On-Region Characteristics

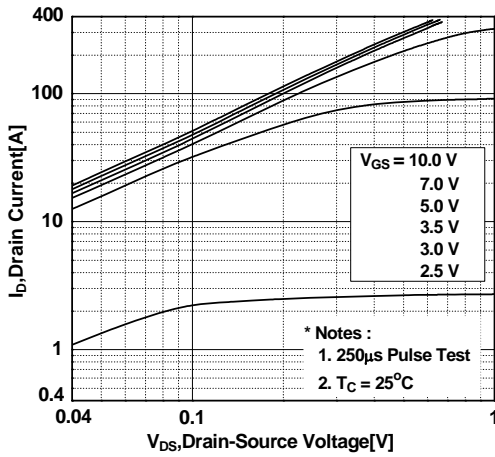

Figure 2. Transfer Characteristics

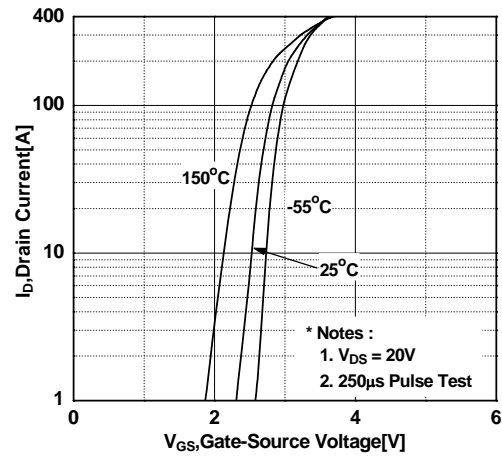

Figure 3. On-Resistance Variation vs. Drain Current and Gate Voltage

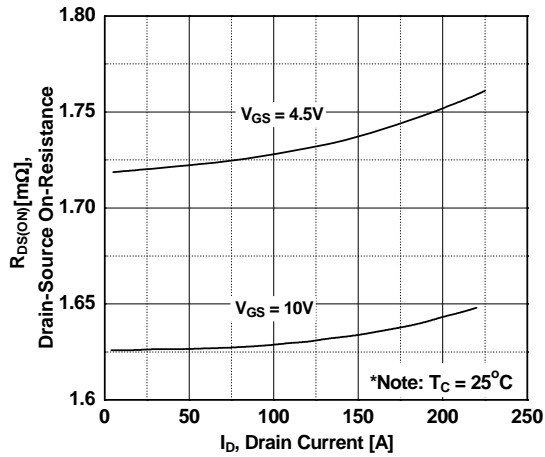

Figure 4. Body Diode Forward Voltage Variation vs. Source Current and Temperature

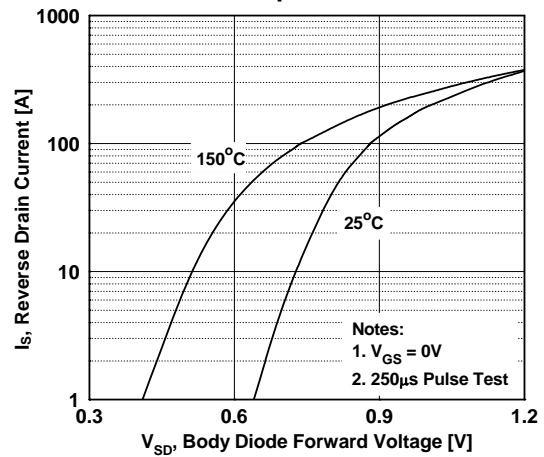

Figure 5. Capacitance Characteristics

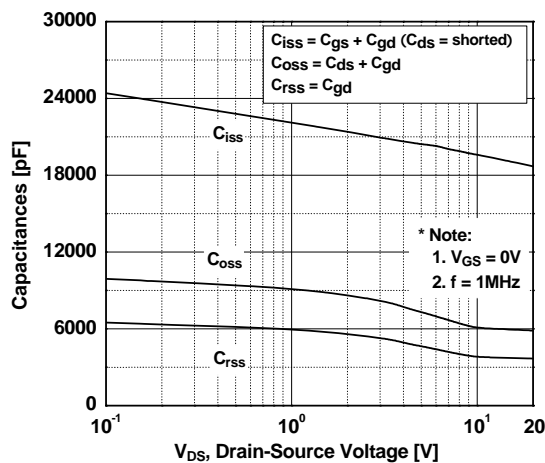
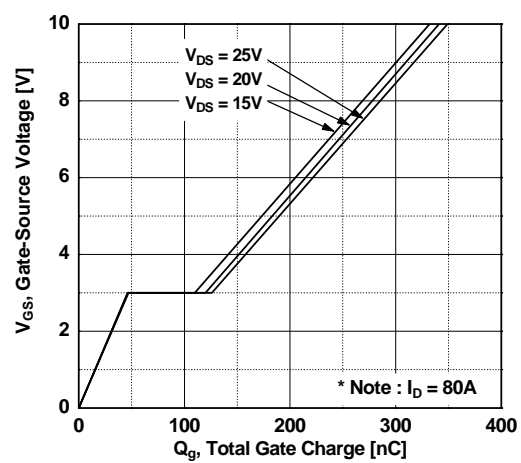

Figure 6. Gate Charge Characteristics



Typical Performance Characteristics (Continued)

Figure 7. Breakdown Voltage Variation vs. Temperature

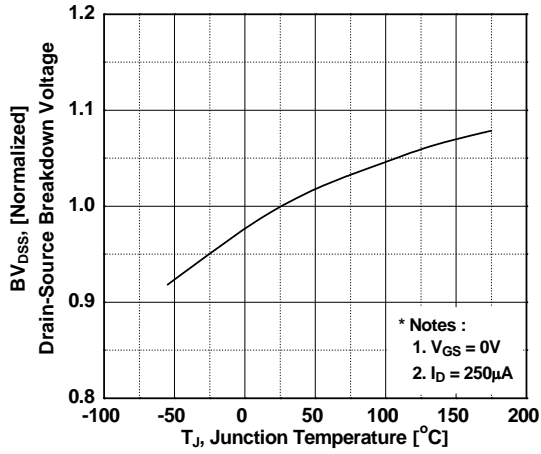

Figure 8. On-Resistance Variation vs. Temperature

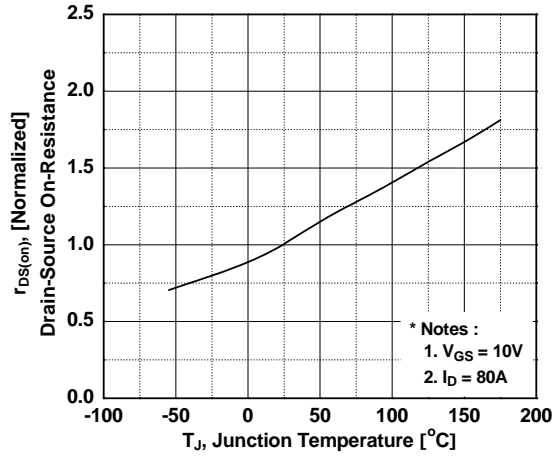

Figure 9. Unclamped Inductive Switching Capability

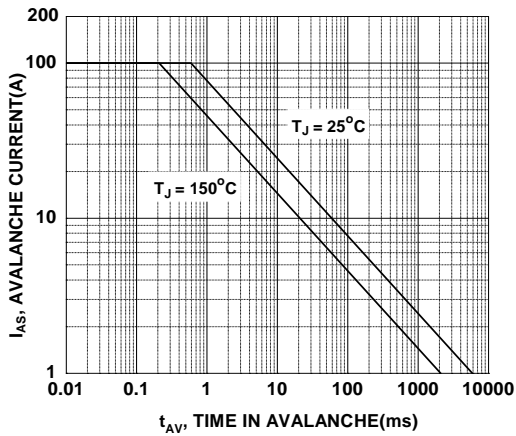

Figure 10. Safe Operating Area

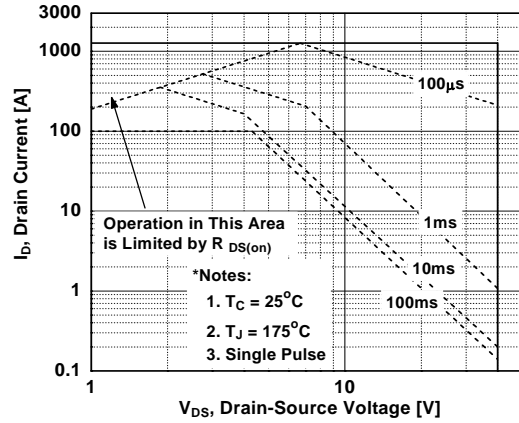
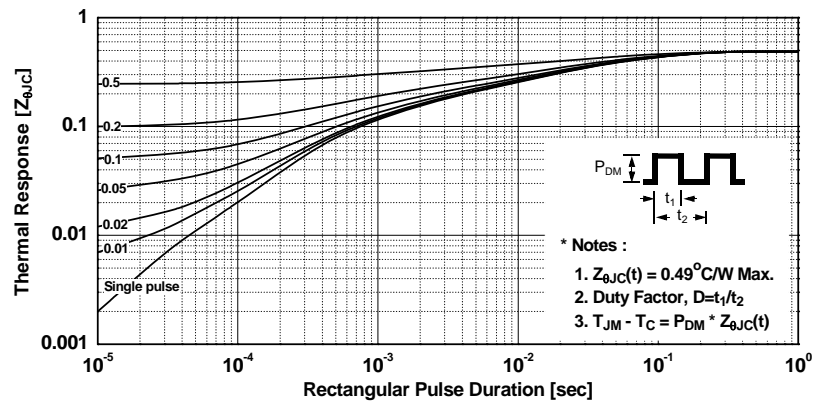
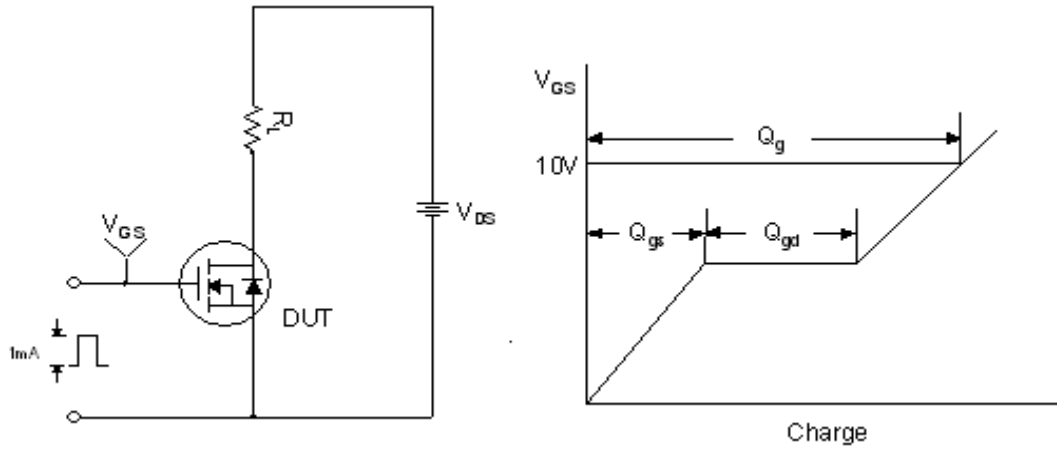

Figure 11. Transient Thermal Response Curve



Gate Charge Test Circuit & Waveform



Resistive Switching Test Circuit & Waveforms

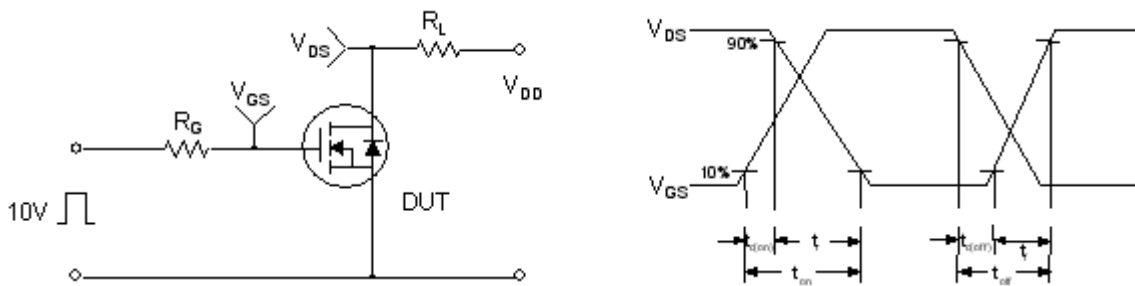

Unclamped Inductive Switching Test Circuit & Waveforms

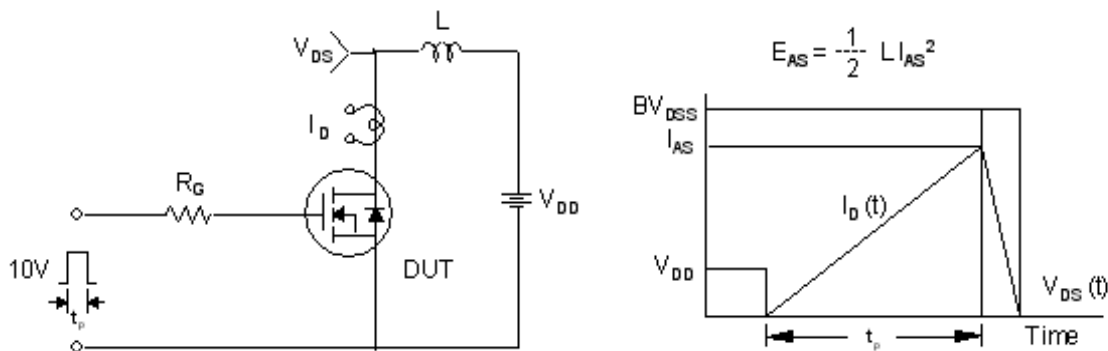

Peak Diode Recovery dv/dt Test Circuit & Waveforms

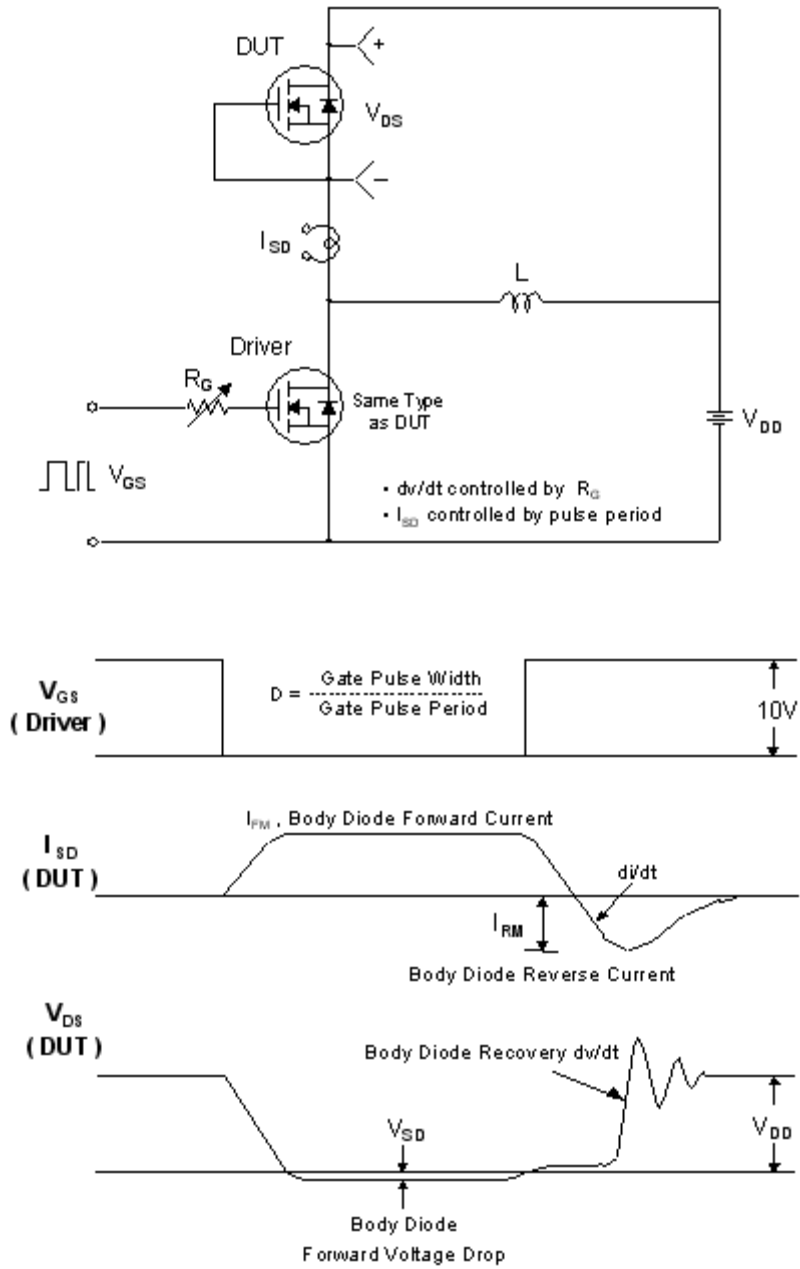

Mechanical Dimensions

TO-220B03

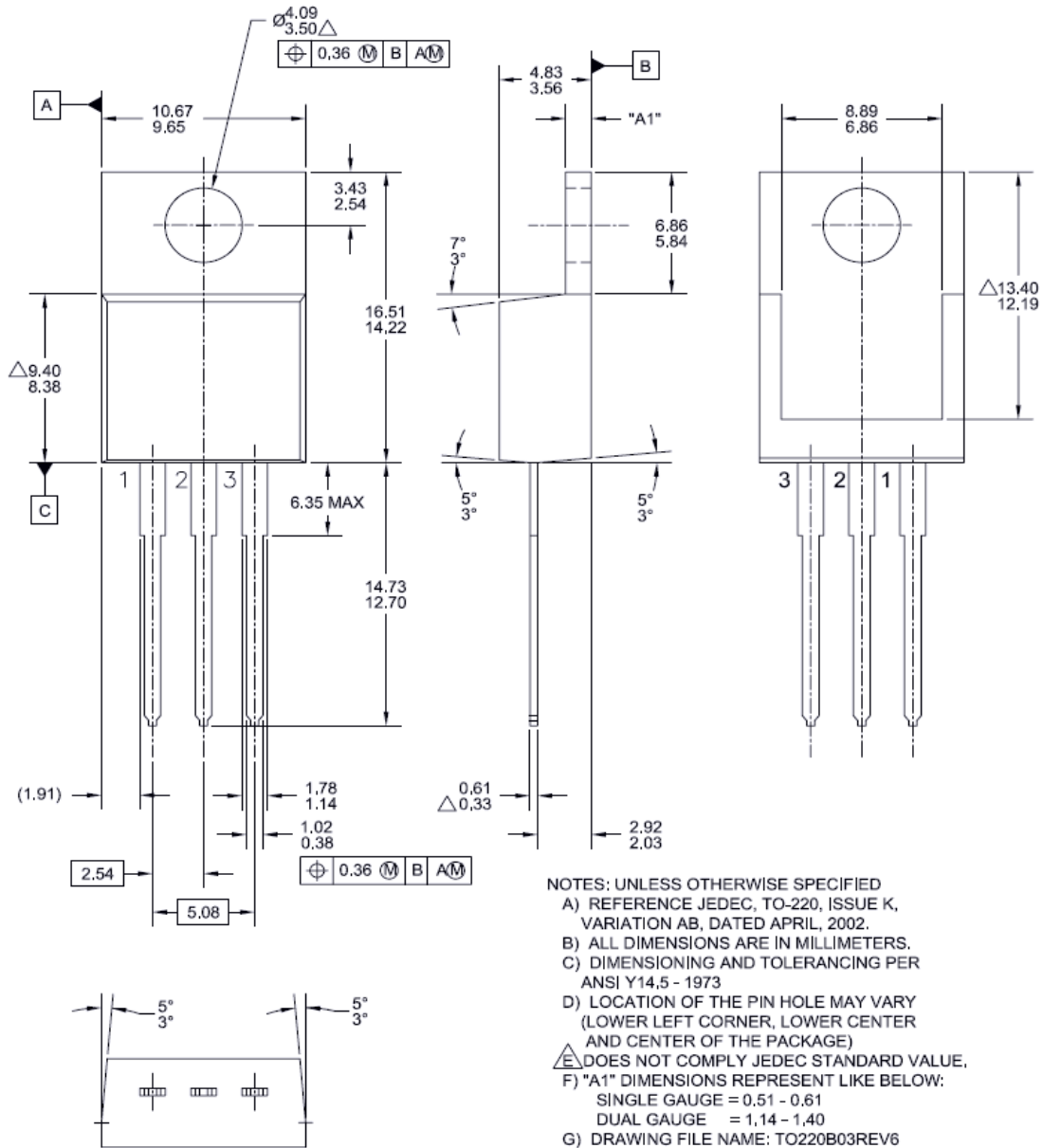



TRADEMARKS

The following includes registered and unregistered trademarks and service marks, owned by Fairchild Semiconductor and/or its global subsidiaries, and is not intended to be an exhaustive list of all such trademarks.

- | | | | |
|--------------------------|---|---------------------------------------|------------------|
| 2Cool™ | FPS™ | PowerTrench® | Sync-Lock™ |
| AccuPower™ | F-PFS™ | PowerXS™ | SYSTEM GENERAL®* |
| AX-CAP®* | FRFET® | Programmable Active Droop™ | TinyBoost™ |
| BitSiC™ | Global Power ResourceSM | QFET® | TinyBuck™ |
| Build it Now™ | Green Bridge™ | QST™ | TinyCalc™ |
| CorePLUS™ | Green FPS™ | Quiet Series™ | TinyLogic® |
| CorePOWER™ | Green FPS™ e-Series™ | RapidConfigure™ | TINYOPTO™ |
| CROSSVOLT™ | Gmax™ | Saving our world, 1mW/W/kW at a time™ | TinyPower™ |
| CTL™ | GTO™ | SignalWise™ | TinyPWM™ |
| Current Transfer Logic™ | IntelliMAX™ | SmartMax™ | TinyWire™ |
| DEUXPEED® | ISOPLANAR™ | SMART START™ | TranSiC® |
| Dual Cool™ | Marking Small Speakers Sound Louder and Better™ | Solutions for Your Success™ | TriFault Detect™ |
| EcoSPARK® | MegaBuck™ | SPM® | TRUECURRENT®* |
| EfficientMax™ | MICROCOUPLER™ | STEALTH™ | µSerDes™ |
| ESBC™ | MicroFET™ | SuperFET® | SerDes® |
| Fairchild® | MicroPak™ | SuperSOT™-3 | UHC® |
| Fairchild Semiconductor® | MicroPak2™ | SuperSOT™-6 | Ultra FRFET™ |
| FACT Quiet Series™ | MillerDrive™ | SuperSOT™-8 | UniFET™ |
| FACT® | MotionMax™ | SupreMOS® | VCX™ |
| FAST® | mWSaver™ | SyncFET™ | VisualMax™ |
| FastvCore™ | OptoHi™ | | VoltagePlus™ |
| FETBench™ | OPTOLOGIC® | | XS™ |
| | OPTOPLANAR® | | |

*Trademarks of System General Corporation, used under license by Fairchild Semiconductor.

DISCLAIMER

FAIRCHILD SEMICONDUCTOR RESERVES THE RIGHT TO MAKE CHANGES WITHOUT FURTHER NOTICE TO ANY PRODUCTS HEREIN TO IMPROVE RELIABILITY, FUNCTION, OR DESIGN. FAIRCHILD DOES NOT ASSUME ANY LIABILITY ARISING OUT OF THE APPLICATION OR USE OF ANY PRODUCT OR CIRCUIT DESCRIBED HEREIN; NEITHER DOES IT CONVEY ANY LICENSE UNDER ITS PATENT RIGHTS, NOR THE RIGHTS OF OTHERS. THESE SPECIFICATIONS DO NOT EXPAND THE TERMS OF FAIRCHILD'S WORLDWIDE TERMS AND CONDITIONS, SPECIFICALLY THE WARRANTY THEREIN, WHICH COVERS THESE PRODUCTS.

LIFE SUPPORT POLICY

FAIRCHILD'S PRODUCTS ARE NOT AUTHORIZED FOR USE AS CRITICAL COMPONENTS IN LIFE SUPPORT DEVICES OR SYSTEMS WITHOUT THE EXPRESS WRITTEN APPROVAL OF FAIRCHILD SEMICONDUCTOR CORPORATION.

As used here in:

- Life support devices or systems are devices or systems which, (a) are intended for surgical implant into the body or (b) support or sustain life, and (c) whose failure to perform when properly used in accordance with instructions for use provided in the labeling, can be reasonably expected to result in a significant injury of the user.
- A critical component in any component of a life support, device, or system whose failure to perform can be reasonably expected to cause the failure of the life support device or system, or to affect its safety or effectiveness.

ANTI-COUNTERFEITING POLICY

Fairchild Semiconductor Corporation's Anti-Counterfeiting Policy. Fairchild's Anti-Counterfeiting Policy is also stated on our external website, www.Fairchildsemi.com, under Sales Support.

Counterfeiting of semiconductor parts is a growing problem in the industry. All manufactures of semiconductor products are experiencing counterfeiting of their parts. Customers who inadvertently purchase counterfeit parts experience many problems such as loss of brand reputation, substandard performance, failed application, and increased cost of production and manufacturing delays. Fairchild is taking strong measures to protect ourselves and our customers from the proliferation of counterfeit parts. Fairchild strongly encourages customers to purchase Fairchild parts either directly from Fairchild or from Authorized Fairchild Distributors who are listed by country on our web page cited above. Products customers buy either from Fairchild directly or from Authorized Fairchild Distributors are genuine parts, have full traceability, meet Fairchild's quality standards for handling and storage and provide access to Fairchild's full range of up-to-date technical and product information. Fairchild and our Authorized Distributors will stand behind all warranties and will appropriately address and warranty issues that may arise. Fairchild will not provide any warranty coverage or other assistance for parts bought from Unauthorized Sources. Fairchild is committed to combat this global problem and encourage our customers to do their part in stopping this practice by buying direct or from authorized distributors.

PRODUCT STATUS DEFINITIONS

Definition of Terms

Datasheet Identification	Product Status	Definition
Advance Information	Formative / In Design	Datasheet contains the design specifications for product development. Specifications may change in any manner without notice.
Preliminary	First Production	Datasheet contains preliminary data; supplementary data will be published at a later date. Fairchild Semiconductor reserves the right to make changes at any time without notice to improve design.
No Identification Needed	Full Production	Datasheet contains final specifications. Fairchild Semiconductor reserves the right to make changes at any time without notice to improve the design.
Obsolete	Not In Production	Datasheet contains specifications on a product that is discontinued by Fairchild Semiconductor. The datasheet is for reference information only.

Rev. 164