

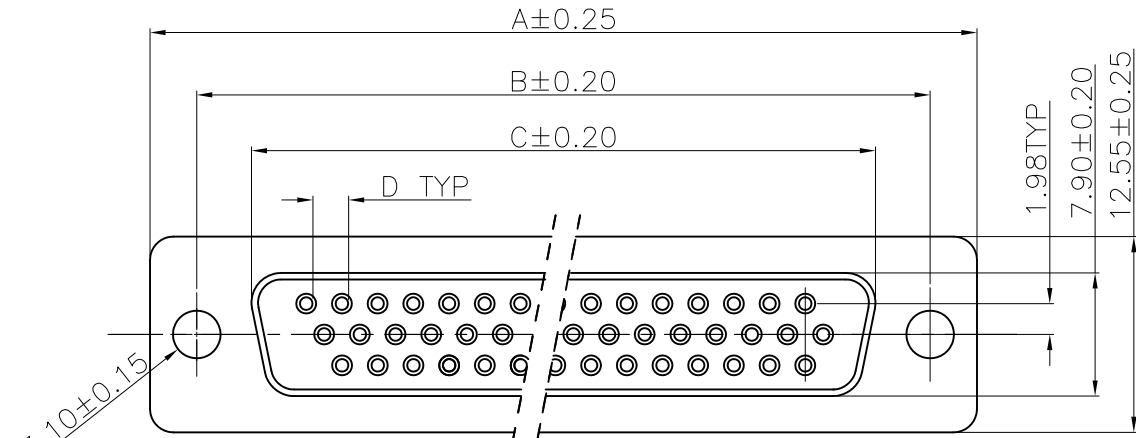

1 | 2

3

4



FOR 26/44/62P

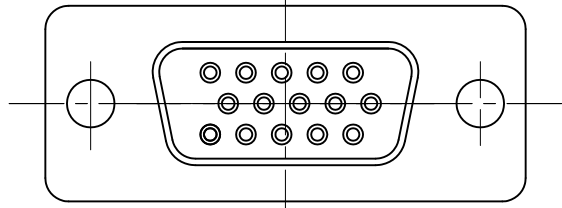
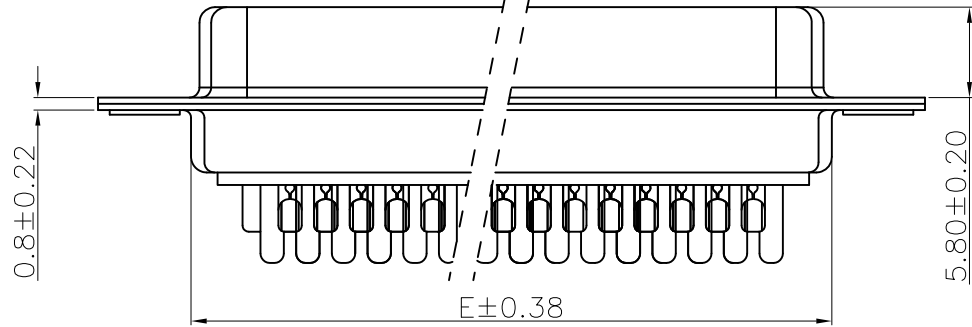

FOR 15P

REMARK:

1. CHARACTERISTICS:

- RATED VOLTAGE: 250V
- RATED CURRENT: 2.5AMP
- CONTACT RESISTANCE: 25mohms MAX. INITIAL, 40mohms MAX. AFTER.
- INSULATION RESISTANCE: 5000Mohms MIN.at 500V DC
- DIELECTRIC STRENGTH: 750VRMS
- OPERATING TEMPERATURE RANGE: -55°C ~105°C
- INSERTION/EXTRACTION FORCE PER CONTACT: 5N Max./0.2N Min.
- MATING/UNMATING CYCLES: 50MATINGS MIN FOR GOLD-FLASH 500MATINGS MIN FOR 30u" GOLD.

2. MATERIAL:

- INSULATORS: THERMOPLASTIC G. F (UL94V-0) BLACK
- CONTACTS: COPPER ALLOY, GOLD(G/F or 30U") TOP OVER CONTACT AREA, 100u" Min MATTE TIN TOP OVER SOLDER AREA, 50u" Min NICKEL UNDER PLATE.
- SHELL: CARBON STEEL, 100u" Min NICKEL TOP OVER, 50u" Min COPPER UNDER PLATE.

3. PART NUMBER DESCRIPTION: 10090770-S XX X X LF

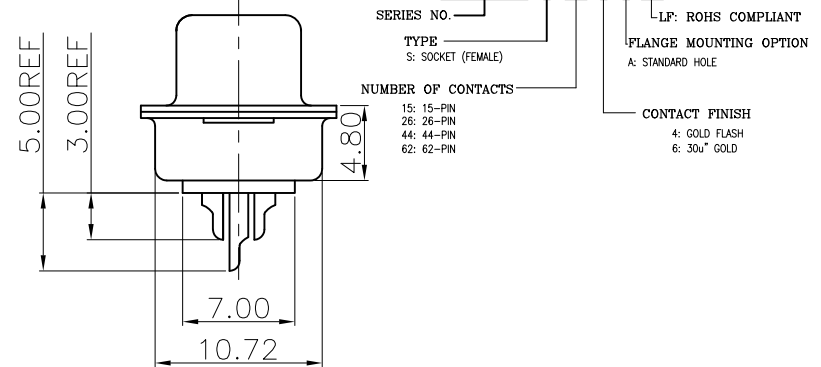

POS.	PART NO.	A	B	C	D	E
15	10090770-S15*ALF	30.81	24.99	16.33	2.29	19.10
26	10090770-S26*ALF	39.24	33.32	24.66	2.29	27.75
44	10090770-S44*ALF	53.04	47.04	38.38	2.29	41.30
62	10090770-S62*ALF	69.32	63.50	54.84	2.41	57.40

mat'l. code				tolerances unless otherwise specified			CUSTOMER COPY		FCI	
ltr	ecn no	dr	date	linear	.X ± 0.38	projection	www.fciconnect.com			
A	T09-1156	J.H	12/10/09	angles	.XX ± 0.25		title			
					.XXX ± 0.10		H/D D-SUB FEMALE SOLDER BUCKET			
				dr	JASON HSU 12/10/09	MM	product family D-SUB		code	
				enr	JASON HSU 12/10/09	scale	size dwg no		TWN	
				chr	GARY HSIEH 12/10/09		1:1	10090770		sheet
				appd	JOSEPH HSIA 12/10/09				1 of 2	
sheet index	revision sheet	A	A							
		1	2							

1 | 2

3

4

Tous droits strictement réservés. Reproduction ou communication a des tiers interdite sous quelque forme que ce soit sans autorisation écrite du propriétaire. Propriete de c FCI. Droits de reproduction FCI.



All rights strictly reserved. Reproduction or issue to third parties in any form whatever is not permitted without written authority from the proprietor. Property of FCI. Copyright FCI.

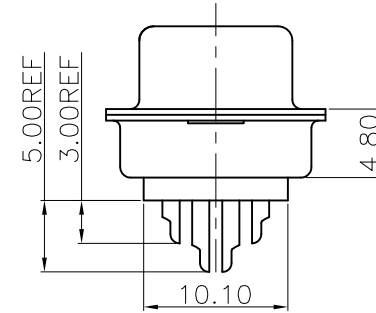
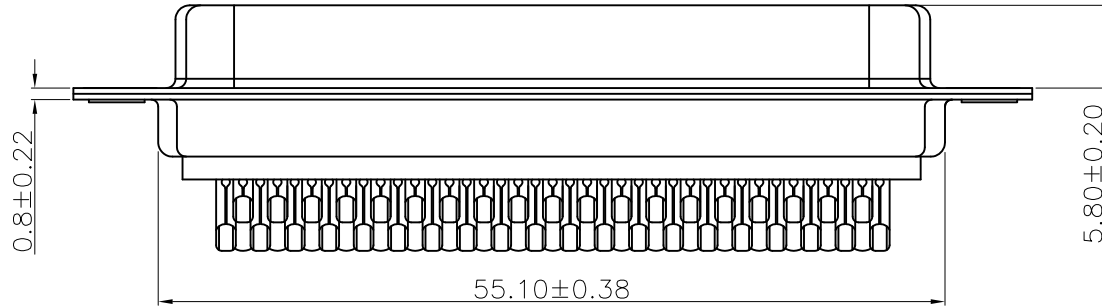
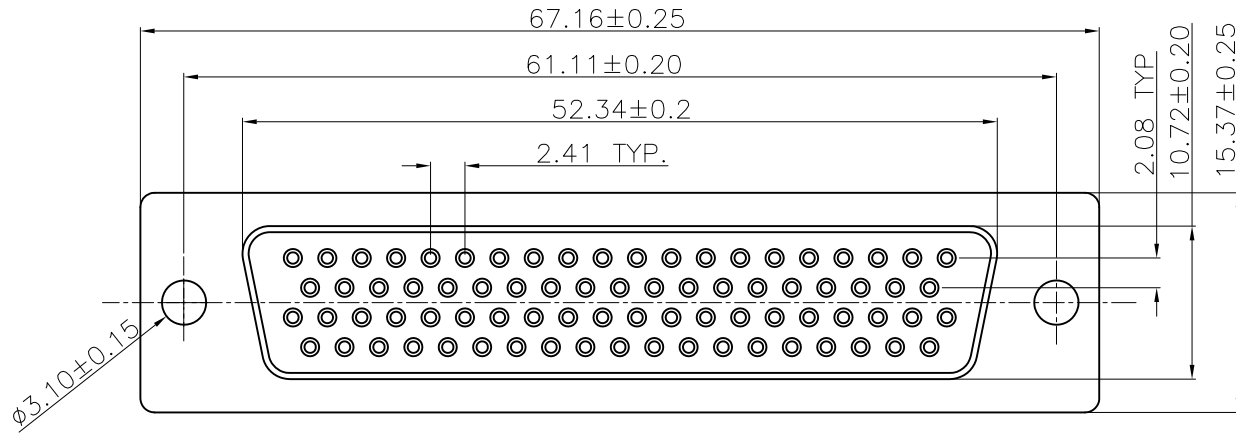

REMARK:

1. CHARACTERISTICS:

RATED VOLTAGE: 250V
 RATED CURRENT: 2.5AMP
 CONTACT RESISTANCE: 35mohms MAX. INITIAL,
 50mohms MAX. AFTER.
 INSULATION RESISTANCE: 5000Mohms MIN. at 500V DC
 DIELECTRIC STRENGTH: 750VRMS
 OPERATING TEMPERATURE RANGE: -55°C ~85°C
 INSERTION/EXTRACTION FORCE PER CONTACT: 5N Max. /0.2N Min Min.
 MATING/UNMATING CYCLES: 50MATINGS MIN FOR GOLD-FLASH
 500MATINGS MIN FOR 30u" GOLD.

2. MATERIAL:

INSULATORS: THERMOPLASTIC G.F (UL94V-0) BLACK
 CONTACTS: COPPER ALLOY, GOLD(G/F or 30u") TOP OVER CONTACT
 AREA, 100u" Min MATTE TIN TOP OVER SOLDER AREA,
 50u" Min NICKEL UNDER PLATE.
 SHELL: CARBON STEEL, 100u" Min NICKEL TOP OVER,
 50u" Min COPPER UNDER PLATE.

3. PART NUMBER DESCRIPTION: 10090770-S XX X X LF

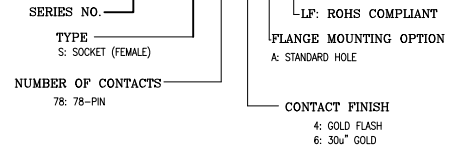

PART NO.: 10090770-S78*ALF

mat'l. code				tolerances unless otherwise specified			CUSTOMER COPY		FCI		www.fciconnect.com	
ltr	ecn no	dr	date	linear	.X ± 0.38		projection	title				
A					.XX ± 0.25			H/D D-SUB 78P FEMALE SOLDER BUCKET				
					.XXX ± 0.10							
				angles	0° ±2°							
				dr	JASON HSU	12/10/09	MM	product family D-SUB		code TWN		
				enr	JASON HSU	12/10/09	scale	size dwg no		sheet 2 of 2		
				chr	GARY HSIEH	12/10/09	1:1	A4		10090770		
				appd	JOSEPH HSIA	12/10/09						
sheet index	revision sheet											