

# Dual, 256-Tap, Low Voltage Digitally Controlled Potentiometer (XDCP™)

## ISL23425

The ISL23425 is a volatile, low voltage, low noise, low power, 256-tap, dual digitally controlled potentiometer (DCP) with an SPI Bus™ interface. It integrates two DCP cores, wiper switches and control logic on a monolithic CMOS integrated circuit.

Each digitally controlled potentiometer is implemented with a combination of resistor elements and CMOS switches. The position of the wipers are controlled by the user through the SPI bus interface. Each potentiometer has an associated volatile Wiper Register (WR<sub>i</sub>, i = 0, 1) that can be directly written to and read by the user. The contents of the WR<sub>i</sub> controls the position of the wiper. When powered on, the wiper of each DCP will always commence at mid-scale (128 tap position).

The low voltage, low power consumption, and small package of the ISL23425 make it an ideal choice for use in battery operated equipment. In addition, the ISL23425 has a V<sub>LOGIC</sub> pin allowing down to 1.2V bus operation, independent from the V<sub>CC</sub> value. This allows for low logic levels to be connected directly to the ISL23425 without passing through a voltage level shifter.

The DCP can be used as a three-terminal potentiometer or as a two-terminal variable resistor in a wide variety of applications including control, parameter adjustments, and signal processing.

## Applications

- Power supply margining
- Trimming sensor circuits
- Gain adjustment in battery powered instruments
- RF power amplifier bias compensation

## Features

- Two potentiometers per package
- 256 resistor taps
- 10kΩ, 50kΩ or 100kΩ total resistance
- SPI serial interface
  - No additional level translator for low bus supply
  - Daisy Chaining of multiple DCPs
- Maximum supply current without serial bus activity (standby)
  - 4μA @ V<sub>CC</sub> and V<sub>LOGIC</sub> = 5V
  - 1.7μA @ V<sub>CC</sub> and V<sub>LOGIC</sub> = 1.7V
- Shutdown Mode
  - Forces the DCP into an end-to-end open circuit and RW<sub>i</sub> is connected to RL<sub>i</sub> internally
  - Reduces power consumption by disconnecting the DCP resistor from the circuit
- Power supply
  - V<sub>CC</sub> = 1.7V to 5.5V analog power supply
  - V<sub>LOGIC</sub> = 1.2V to 5.5V SPI bus/logic power supply
- Wiper resistance: 70Ω typical @ V<sub>CC</sub> = 3.3V
- Power-on preset to mid-scale (128 tap position)
- Extended industrial temperature range: -40°C to +125°C
- 14 Ld TSSOP or 16 Ld μTQFN packages
- Pb-free (RoHS compliant)

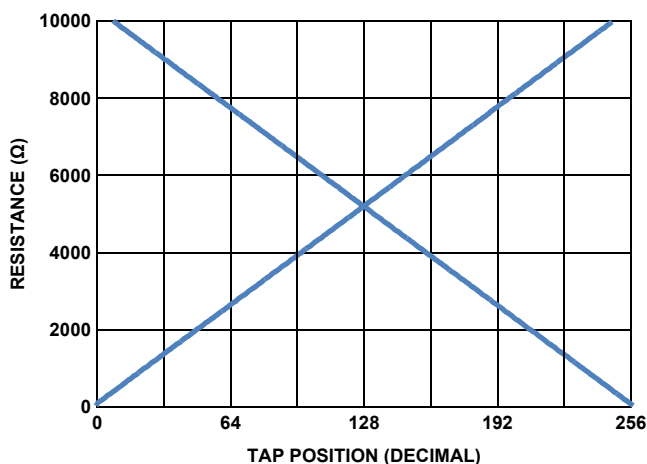

FIGURE 1. FORWARD AND BACKWARD RESISTANCE vs TAP POSITION, 10kΩ DCP

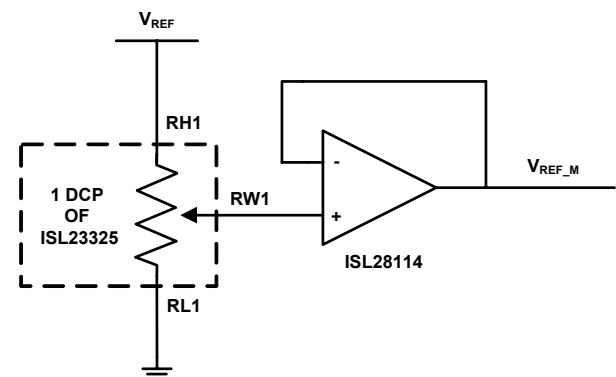
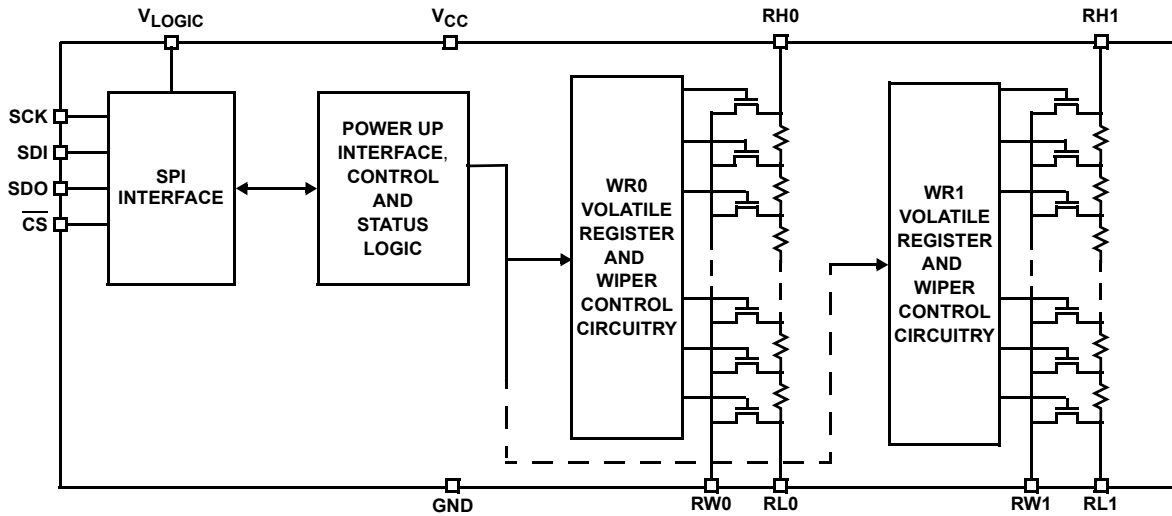

FIGURE 2. V<sub>REF</sub> ADJUSTMENT

# ISL23425

## Block Diagram



## Pin Configurations

ISL23425  
(14 LD TSSOP)  
TOP VIEW

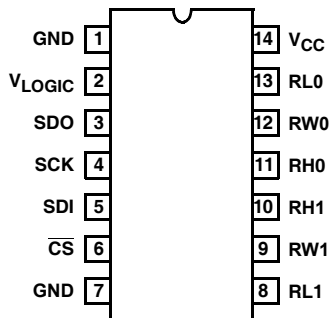

ISL23425  
(16 LD  $\mu$ TQFN)  
TOP VIEW

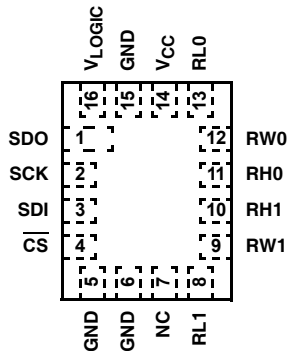

## Pin Descriptions

TSSOP	$\mu$ TQFN	SYMBOL	DESCRIPTION
1, 7	5, 6, 15	GND	Ground pin
2	16	V <sub>LOGIC</sub>	SPI bus/logic supply Range 1.2V to 5.5V
3	1	SDO	Logic Pin - Serial bus data output (configurable)
4	2	SCK	Logic Pin - Serial bus clock input
5	3	SDI	Logic Pin - Serial bus data input
6	4	$\overline{\text{CS}}$	Logic Pin - Active low chip select
8	8	RL1	DCP1 "low" terminal
9	9	RW1	DCP1 wiper terminal
10	10	RH1	DCP1 "high" terminal
11	11	RH0	DCP0 "high" terminal
12	12	RW0	DCP0 wiper terminal
13	13	RL0	DCP0 "low" terminal
14	14	V <sub>CC</sub>	Analog power supply. Range 1.7V to 5.5V
	7	NC	Not Connected

# ISL23425

## Ordering Information

PART NUMBER (Note 5)	PART MARKING	RESISTANCE OPTION (k $\Omega$ )	TEMP RANGE (°C)	PACKAGE (Pb-free)	PKG. DWG. #
ISL23425TFVZ (Notes 1, 3)	23425 TFVZ	100	-40 to +125	14 Ld TSSOP	M14.173
ISL23425UFVZ (Notes 1, 3)	23425 UFVZ	50	-40 to +125	14 Ld TSSOP	M14.173
23425WFVZ (Notes 1, 3)	23425 WFVZ	10	-40 to +125	14 Ld TSSOP	M14.173
ISL23425TFRUZ-T7A (Notes 2, 4)	GBJ	100	-40 to +125	16 Ld 2.6x1.8 $\mu$ TQFN	L16.2.6x1.8A
ISL23425TFRUZ-TK (Notes 2, 4)	GBJ	100	-40 to +125	16 Ld 2.6x1.8 $\mu$ TQFN	L16.2.6x1.8A
ISL23425UFRUZ-T7A (Notes 2, 4)	GBH	50	-40 to +125	16 Ld 2.6x1.8 $\mu$ TQFN	L16.2.6x1.8A
ISL23425UFRUZ-TK (Notes 2, 4)	GBH	50	-40 to +125	16 Ld 2.6x1.8 $\mu$ TQFN	L16.2.6x1.8A
ISL23425WFRUZ-T7A (Notes 2, 4)	GBG	10	-40 to +125	16 Ld 2.6x1.8 $\mu$ TQFN	L16.2.6x1.8A
ISL23425WFRUZ-TK (Notes 2, 4)	GBG	10	-40 to +125	16 Ld 2.6x1.8 $\mu$ TQFN	L16.2.6x1.8A

### NOTES:

1. Add "-TK" suffix for 1k unit or "-T7A" suffix for 250 unit Tape and Reel options. Please refer to [TB347](#) for details on reel specifications.
2. Please refer to [TB347](#) for details on reel specifications.
3. These Intersil Pb-free plastic packaged products employ special Pb-free material sets, molding compounds/die attach materials, and 100% matte tin plate plus anneal (e3 termination finish, which is RoHS compliant and compatible with both SnPb and Pb-free soldering operations). Intersil Pb-free products are MSL classified at Pb-free peak reflow temperatures that meet or exceed the Pb-free requirements of IPC/JEDEC J STD-020.
4. These Intersil Pb-free plastic packaged products employ special Pb-free material sets; molding compounds/die attach materials and NiPdAu plate-e4 termination finish, which is RoHS compliant and compatible with both SnPb and Pb-free soldering operations. Intersil Pb-free products are MSL classified at Pb-free peak reflow temperatures that meet or exceed the Pb-free requirements of IPC/JEDEC J STD-020
5. For Moisture Sensitivity Level (MSL), please see device information page for [ISL23425](#). For more information on MSL please see techbrief [TB363](#).

# ISL23425

## Absolute Maximum Ratings

Supply Voltage Range	
V <sub>CC</sub>	-0.3V to 6.0V
V <sub>LOGIC</sub>	-0.3V to 6.0V
Voltage on Any DCP Terminal Pin	-0.3V to 6.0V
Voltage on Any Digital Pins	-0.3V to 6.0V
Wiper current I <sub>W</sub> (10s)	±6mA
ESD Rating	
Human Body Model (Tested per JESD22-A114E)	4.5kV
CDM Model (Tested per JESD22-A114E)	1kV
Machine Model (Tested per JESD22-A115-A)	300V
Latch Up (Tested per JESD-78B; Class 2, Level A)	100mA @ +125°C

## Thermal Information

Thermal Resistance (Typical)	$\theta_{JA}$ (°C/W)	$\theta_{JC}$ (°C/W)
14 Ld TSSOP Package (Notes 6, 7)	112	40
16 Ld $\mu$ TQFN Package (Notes 6, 7)	110	64
Maximum Junction Temperature (Plastic Package)	+150°C	
Storage Temperature Range	-65°C to +150°C	
Pb-Free Reflow Profile	see link below	
	<a href="http://www.intersil.com/pbfree/Pb-FreeReflow.asp">http://www.intersil.com/pbfree/Pb-FreeReflow.asp</a>	

## Recommended Operating Conditions

Temperature	-40°C to +125°C
V <sub>CC</sub> Supply Voltage	1.7V to 5.5V
V <sub>LOGIC</sub> Supply Voltage	1.2V to 5.5V
DCP Terminal Voltage	.0 to V <sub>CC</sub>
Max Wiper Current	±3mA

**CAUTION:** Do not operate at or near the maximum ratings listed for extended periods of time. Exposure to such conditions may adversely impact product reliability and result in failures not covered by warranty.

### NOTES:

- $\theta_{JA}$  is measured with the component mounted on a high effective thermal conductivity test board in free air. See Tech Brief [TB379](#) for details.
- For  $\theta_{JC}$ , the "case temp" location is the center top of the package.

**Analog Specifications** V<sub>CC</sub> = 2.7V to 5.5V, V<sub>LOGIC</sub> = 1.2V to 5.5V over recommended operating conditions unless otherwise stated. **Boldface limits apply over the operating temperature range, -40°C to +125°C.**

SYMBOL	PARAMETER	TEST CONDITIONS	MIN (Note 20)	TYP (Note 8)	MAX (Note 20)	UNITS	
R <sub>TOTAL</sub>	RH to RL Resistance	W option		10		k $\Omega$	
		U option		50		k $\Omega$	
		T option		100		k $\Omega$	
	RH to RL Resistance Tolerance			<b>-20</b>	$\pm 2$	<b>+20</b>	%
	End-to-End Temperature Coefficient	W option			125		ppm/°C
		U option			65		ppm/°C
T option				45		ppm/°C	
V <sub>RH</sub> , V <sub>RRL</sub>	DCP Terminal Voltage	V <sub>RH</sub> or V <sub>RRL</sub> to GND	<b>0</b>		<b>V<sub>CC</sub></b>	V	
R <sub>W</sub>	Wiper Resistance	RH - floating, V <sub>RRL</sub> = 0V, force I <sub>W</sub> current to the wiper, I <sub>W</sub> = (V <sub>CC</sub> - V <sub>RRL</sub> )/R <sub>TOTAL</sub> , V <sub>CC</sub> = 2.7V to 5.5V		70	<b>200</b>	$\Omega$	
		V <sub>CC</sub> = 1.7V		580		$\Omega$	
C <sub>H</sub> /C <sub>L</sub> /C <sub>W</sub>	Terminal Capacitance	See "DCP Macro Model" on page 8		32/32/32		pF	
I <sub>LkgDCP</sub>	Leakage on DCP Pins	Voltage at pin from GND to V <sub>CC</sub>	<b>-0.4</b>	<0.1	<b>0.4</b>	$\mu$ A	
Noise	Resistor Noise Density	Wiper at middle point, W option		16		nV/ $\sqrt{\text{Hz}}$	
		Wiper at middle point, U option		49		nV/ $\sqrt{\text{Hz}}$	
		Wiper at middle point, T option		61		nV/ $\sqrt{\text{Hz}}$	
Feed Thru	Digital Feed-through from Bus to Wiper	Wiper at middle point		-65		dB	
PSRR	Power Supply Reject Ratio	Wiper output change if V <sub>CC</sub> change $\pm 10\%$ ; wiper at middle point		-75		dB	
<b>VOLTAGE DIVIDER MODE (0V @ RL; V<sub>CC</sub> @ RH; measured at RW, unloaded)</b>							
INL (Note 13)	Integral Non-linearity, Guaranteed Monotonic	W option	<b>-1.0</b>	$\pm 0.5$	<b>+1.0</b>	LSB (Note 9)	
		U, T option	<b>-0.5</b>	$\pm 0.15$	<b>+0.5</b>	LSB (Note 9)	

# ISL23425

**Analog Specifications**  $V_{CC} = 2.7V$  to  $5.5V$ ,  $V_{LOGIC} = 1.2V$  to  $5.5V$  over recommended operating conditions unless otherwise stated.  
**Boldface limits apply over the operating temperature range,  $-40^{\circ}C$  to  $+125^{\circ}C$ . (Continued)**

SYMBOL	PARAMETER	TEST CONDITIONS	MIN (Note 20)	TYP (Note 8)	MAX (Note 20)	UNITS
DNL (Note 12)	Differential Non-linearity, Guaranteed Monotonic	W option	<b>-1</b>	$\pm 0.4$	<b>+1</b>	LSB (Note 9)
		U, T option	<b>-0.4</b>	$\pm 0.1$	<b>+0.4</b>	LSB (Note 9)
FSerror (Note 11)	Full-scale Error	W option	<b>-5</b>	-2	<b>0</b>	LSB (Note 9)
		U, T option	<b>-2</b>	-0.5	<b>0</b>	LSB (Note 9)
ZSerror (Note 10)	Zero-scale Error	W option	<b>0</b>	2	<b>5</b>	LSB (Note 9)
		U, T option	<b>0</b>	0.4	<b>2</b>	LSB (Note 9)
Vmatch (Note 22)	DCP to DCP Matching	DCPs at same tap position, same voltage at all RH terminals, and same voltage at all RL terminals	<b>-2</b>	$\pm 0.5$	<b>2</b>	LSB (Note 9)
TC <sub>V</sub> (Note 14)	Ratiometric Temperature Coefficient	W option, Wiper Register set to 80 hex		8		ppm/ $^{\circ}C$
		U option, Wiper Register set to 80 hex		4		ppm/ $^{\circ}C$
		T option, Wiper Register set to 80 hex		2.3		ppm/ $^{\circ}C$
t <sub>LS_Settling</sub>	Large Signal Wiper Settling Time	From code 0 to FF hex, measured from 0 to 1 LSB settling of the wiper		300		ns
f <sub>cutoff</sub>	-3dB Cutoff Frequency	Wiper at middle point W option		1200		kHz
		Wiper at middle point U option		250		kHz
		Wiper at middle point T option		120		kHz
<b>RHEOSTAT MODE (Measurements between RW and RL pins with RH not connected, or between RW and RH with RL not connected)</b>						
R <sub>INL</sub> (Note 18)	Integral Non-Linearity, Guaranteed Monotonic	W option; $V_{CC} = 2.7V$ to $5.5V$	<b>-2.0</b>	$\pm 1$	<b>+2.0</b>	MI (Note 15)
		W option; $V_{CC} = 1.7V$		10.5		MI (Note 15)
		U, T option; $V_{CC} = 2.7V$ to $5.5V$	<b>-1.0</b>	$\pm 0.3$	<b>+1.0</b>	MI (Note 15)
		U, T option; $V_{CC} = 1.7V$		2.1		MI (Note 15)
R <sub>DNL</sub> (Note 17)	Differential Non-Linearity, Guaranteed Monotonic	W option; $V_{CC} = 2.7V$ to $5.5V$	<b>-1</b>	$\pm 0.4$	<b>+1</b>	MI (Note 15)
		W option; $V_{CC} = 1.7V$		$\pm 0.6$		MI (Note 15)
		U, T option; $V_{CC} = 2.7V$ to $5.5V$	<b>-0.5</b>	$\pm 0.15$	<b>+0.5</b>	MI (Note 15)
		U, T option; $V_{CC} = 1.7V$		$\pm 0.35$		MI (Note 15)
R <sub>offset</sub> (Note 16)	Offset, wiper at 0 position	W option; $V_{CC} = 2.7V$ to $5.5V$	<b>0</b>	3	<b>5.5</b>	MI (Note 15)
		W option; $V_{CC} = 1.7V$		6.3		MI (Note 15)
		U, T option; $V_{CC} = 2.7V$ to $5.5V$	<b>0</b>	0.5	<b>2</b>	MI (Note 15)
		U, T option; $V_{CC} = 1.7V$		1.1		MI (Note 15)
Rmatch (Note 23)	DCP to DCP Matching	Any two DCPs at the same tap position with the same terminal voltages	<b>-2</b>	$\pm 0.5$	<b>2</b>	LSB (Note 9)

# ISL23425

**Analog Specifications**  $V_{CC} = 2.7V$  to  $5.5V$ ,  $V_{LOGIC} = 1.2V$  to  $5.5V$  over recommended operating conditions unless otherwise stated.  
**Boldface limits apply over the operating temperature range, -40°C to +125°C. (Continued)**

SYMBOL	PARAMETER	TEST CONDITIONS	MIN (Note 20)	TYP (Note 8)	MAX (Note 20)	UNITS
TCR (Note 19)	Resistance temperature coefficient	W option; Wiper register set between 32 hex and FF hex		170		ppm/°C
		U option; Wiper register set between 32 hex and FF hex		80		ppm/°C
		T option; Wiper register set between 32 hex and FF hex		50		ppm/°C

**Operating Specifications**  $V_{CC} = 2.7V$  to  $5.5V$ ,  $V_{LOGIC} = 1.2V$  to  $5.5V$  over recommended operating conditions unless otherwise stated.  
**Boldface limits apply over the operating temperature range, -40°C to +125°C.**

SYMBOL	PARAMETER	TEST CONDITIONS	MIN (Note 20)	TYP (Note 8)	MAX (Note 20)	UNITS
I <sub>LOGIC</sub>	V <sub>LOGIC</sub> Supply Current (Write/Read)	V <sub>LOGIC</sub> = 5.5V, V <sub>CC</sub> = 5.5V, f <sub>SCK</sub> = 5MHz (for SPI active read and write)			<b>1.5</b>	mA
		V <sub>LOGIC</sub> = 1.2V, V <sub>CC</sub> = 1.7V, f <sub>SCK</sub> = 1MHz (for SPI active read and write)			<b>30</b>	µA
I <sub>CC</sub>	V <sub>CC</sub> Supply Current (Write/Read)	V <sub>LOGIC</sub> = 5.5V, V <sub>CC</sub> = 5.5V			<b>100</b>	µA
		V <sub>LOGIC</sub> = 1.2V, V <sub>CC</sub> = 1.7V			<b>10</b>	µA
I <sub>LOGIC SB</sub>	V <sub>LOGIC</sub> Standby Current	V <sub>LOGIC</sub> = V <sub>CC</sub> = 5.5V, SPI interface in standby			<b>2</b>	µA
		V <sub>LOGIC</sub> = 1.2V, V <sub>CC</sub> = 1.7V, SPI interface in standby			<b>0.5</b>	µA
I <sub>CC SB</sub>	V <sub>CC</sub> Standby Current	V <sub>LOGIC</sub> = V <sub>CC</sub> = 5.5V, SPI interface in standby			<b>2</b>	µA
		V <sub>LOGIC</sub> = 1.2V, V <sub>CC</sub> = 1.7V, SPI interface in standby			<b>1.2</b>	µA
I <sub>LOGIC SHDN</sub>	V <sub>LOGIC</sub> Shutdown Current	V <sub>LOGIC</sub> = V <sub>CC</sub> = 5.5V, SPI interface in standby			<b>2</b>	µA
		V <sub>LOGIC</sub> = 1.2V, V <sub>CC</sub> = 1.7V, SPI interface in standby			<b>0.5</b>	µA
I <sub>CC SHDN</sub>	V <sub>CC</sub> Shutdown Current	V <sub>LOGIC</sub> = V <sub>CC</sub> = 5.5V, SPI interface in standby			<b>2</b>	µA
		V <sub>LOGIC</sub> = 1.2V, V <sub>CC</sub> = 1.7V, SPI interface in standby			<b>1.2</b>	µA
I <sub>LkgDig</sub>	Leakage Current, at Pins $\overline{CS}$ , SDO, SDI, SCK	Voltage at pin from GND to V <sub>LOGIC</sub>	<b>-0.4</b>	<0.1	<b>0.4</b>	µA
t <sub>DCP</sub>	Wiper Response Time	$\overline{CS}$ rising edge to the new position of the wiper (changes from 10% to 90% FS) W, U, T options specified top to bottom		0.4		µs
				<b>1.5</b>		µs
				3.5		µs
t <sub>ShdnRec</sub>	DCP Recall Time from Shutdown Mode	$\overline{CS}$ rising edge to wiper recalled position and RH connection		1.5		µs
V <sub>CC</sub> , V <sub>LOGIC</sub> Ramp	V <sub>CC</sub> , V <sub>LOGIC</sub> Ramp Rate (Note 21)	Ramp monotonic at any level	<b>0.01</b>		<b>50</b>	V/ms

**Serial Interface Specification** For SCK, SDI, SDO,  $\overline{CS}$  Unless Otherwise Noted.

SYMBOL	PARAMETER	TEST CONDITIONS	MIN (Note 20)	TYP (Note 8)	MAX (Note 20)	UNITS
V <sub>IL</sub>	Input LOW Voltage		-0.3		0.3 x V <sub>LOGIC</sub>	V
V <sub>IH</sub>	Input HIGH Voltage		0.7 x V <sub>LOGIC</sub>		V <sub>LOGIC</sub> + 0.3	V
Hysteresis	SDI and SCK Input Buffer Hysteresis	V <sub>LOGIC</sub> > 2V	0.05 x V <sub>LOGIC</sub>			V
		V <sub>LOGIC</sub> < 2V	0.1 x V <sub>LOGIC</sub>			V

# ISL23425

## Serial Interface Specification For SCK, SDI, SDO, $\overline{\text{CS}}$ Unless Otherwise Noted. (Continued)

SYMBOL	PARAMETER	TEST CONDITIONS	MIN (Note 20)	TYP (Note 8)	MAX (Note 20)	UNITS
V <sub>OL</sub>	SDO Output Buffer LOW Voltage	I <sub>OL</sub> = 3mA, V <sub>LOGIC</sub> > 2V	0		0.4	V
		I <sub>OL</sub> = 1.5mA, V <sub>LOGIC</sub> < 2V			0.2 x V <sub>LOGIC</sub>	V
R <sub>pu</sub>	SDO Pull-Up Resistor Off-Chip	Maximum is determined by t <sub>RO</sub> and t <sub>FO</sub> with maximum bus load C <sub>b</sub> = 30pF, f <sub>SCK</sub> = 5MHz			1.5	kΩ
C <sub>pin</sub>	SCK, SDO, SDI, $\overline{\text{CS}}$ Pin Capacitance			10		pF
f <sub>SCK</sub>	SCK Frequency	V <sub>LOGIC</sub> = 1.7V to 5.5V			5	MHz
		V <sub>LOGIC</sub> = 1.2V to 1.6V			1	MHz
t <sub>CYC</sub>	SPI Clock Cycle Time	V <sub>LOGIC</sub> ≥ 1.7V	200			ns
t <sub>WH</sub>	SPI Clock High Time	V <sub>LOGIC</sub> ≥ 1.7V	100			ns
t <sub>WL</sub>	SPI Clock Low Time	V <sub>LOGIC</sub> ≥ 1.7V	100			ns
t <sub>LEAD</sub>	Lead Time	V <sub>LOGIC</sub> ≥ 1.7V	250			ns
t <sub>LAG</sub>	Lag Time	V <sub>LOGIC</sub> ≥ 1.7V	250			ns
t <sub>SU</sub>	SDI, SCK and $\overline{\text{CS}}$ Input Setup Time	V <sub>LOGIC</sub> ≥ 1.7V	50			ns
t <sub>H</sub>	SDI, SCK and $\overline{\text{CS}}$ Input Hold Time	V <sub>LOGIC</sub> ≥ 1.7V	50			ns
t <sub>RI</sub>	SDI, SCK and $\overline{\text{CS}}$ Input Rise Time	V <sub>LOGIC</sub> ≥ 1.7V	10			ns
t <sub>FI</sub>	SDI, SCK and $\overline{\text{CS}}$ Input Fall Time	V <sub>LOGIC</sub> ≥ 1.7V	10		20	ns
t <sub>DIS</sub>	SDO Output Disable Time	V <sub>LOGIC</sub> ≥ 1.7V	0		100	ns
t <sub>SO</sub>	SDO Output Setup Time	V <sub>LOGIC</sub> ≥ 1.7V	50			ns
t <sub>V</sub>	SDO Output Valid Time	V <sub>LOGIC</sub> ≥ 1.7V	150			ns
t <sub>HO</sub>	SDO Output Hold Time	V <sub>LOGIC</sub> ≥ 1.7V	0			ns
t <sub>RO</sub>	SDO Output Rise Time	R <sub>pu</sub> = 1.5k, C <sub>bus</sub> = 30pF			60	ns
t <sub>FO</sub>	SDO Output Fall Time	R <sub>pu</sub> = 1.5k, C <sub>bus</sub> = 30pF			60	ns
t <sub>CS</sub>	$\overline{\text{CS}}$ Deselect Time		2			μs

### NOTES:

8. Typical values are for T<sub>A</sub> = +25°C and 3.3V supply voltages.
9. LSB = [V(RW)<sub>255</sub> - V(RW)<sub>0</sub>]/255. V(RW)<sub>255</sub> and V(RW)<sub>0</sub> are V(RW) for the DCP register set to FF hex and 00 hex respectively. LSB is the incremental voltage when changing from one tap to an adjacent tap.
10. ZS error = V(RW)<sub>0</sub>/LSB.
11. FS error = [V(RW)<sub>255</sub> - V<sub>CC</sub>]/LSB.
12. DNL = [V(RW)<sub>i</sub> - V(RW)<sub>i-1</sub>]/LSB-1, for i = 1 to 255. i is the DCP register setting.
13. INL = [V(RW)<sub>i</sub> - i • LSB - V(RW)<sub>0</sub>]/LSB for i = 1 to 255
14.  $TC_V = \frac{\text{Max}(V(RW)_i) - \text{Min}(V(RW)_i)}{V(RW)_i(+25^\circ\text{C})} \times \frac{10^6}{+165^\circ\text{C}}$  for i = 16 to 255 decimal, T = -40°C to +125°C. Max() is the maximum value of the wiper voltage and Min() is the minimum value of the wiper voltage over the temperature range.
15. MI = |RW<sub>255</sub> - RW<sub>0</sub>|/255. MI is a minimum increment. RW<sub>255</sub> and RW<sub>0</sub> are the measured resistances for the DCP register set to FF hex and 00 hex respectively.
16. Roffset = RW<sub>0</sub>/MI, when measuring between RW and RL.  
Roffset = RW<sub>255</sub>/MI, when measuring between RW and RH.
17. RDNL = (RW<sub>i</sub> - RW<sub>i-1</sub>)/MI -1, for i = 16 to 255.
18. RINL = [RW<sub>i</sub> - (MI • i) - RW<sub>0</sub>]/MI, for i = 16 to 255.
19.  $TC_R = \frac{[\text{Max}(R_i) - \text{Min}(R_i)]}{R_i(+25^\circ\text{C})} \times \frac{10^6}{+165^\circ\text{C}}$  for i = 16 to 255, T = -40°C to +125°C. Max() is the maximum value of the resistance and Min() is the minimum value of the resistance over the temperature range.
20. Compliance to datasheet limits is assured by one or more methods: production test, characterization and/or design.
21. It is preferable to ramp up both the V<sub>LOGIC</sub> and the V<sub>CC</sub> supplies at the same time. If this is not possible it is recommended to ramp-up the V<sub>LOGIC</sub> first followed by the V<sub>CC</sub>.
22. VMATCH = [V(RW<sub>x</sub>)<sub>i</sub> - V(RW<sub>y</sub>)<sub>i</sub>]/LSB, for i = 1 to 255, x = 0 to 1 and y = 0 to 1.
23. RMATCH = (RW<sub>i,x</sub> - RW<sub>i,y</sub>)/MI, for i = 1 to 255, x = 0 to 1 and y = 0 to 1.

## DCP Macro Model

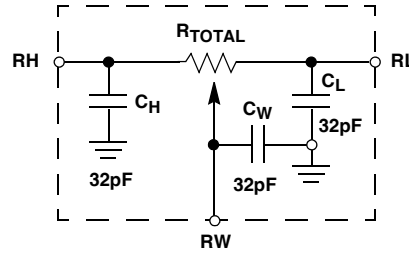

## Timing Diagrams

### Input Timing

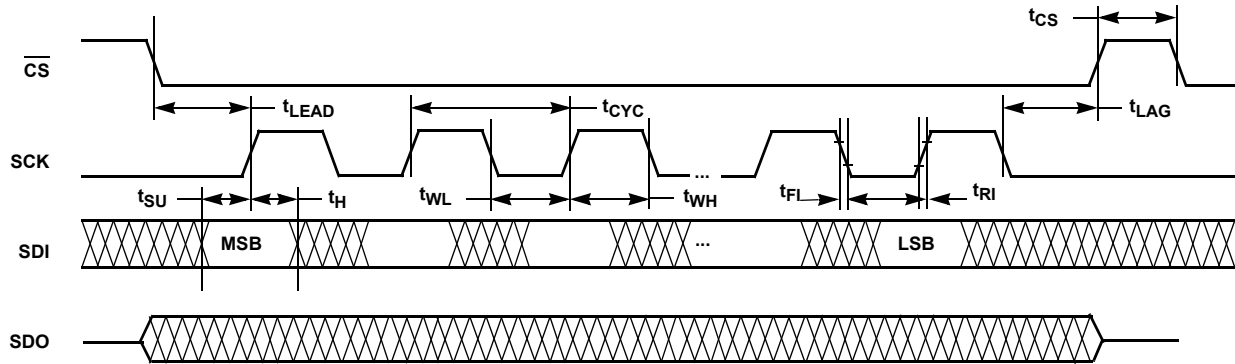

### Output Timing

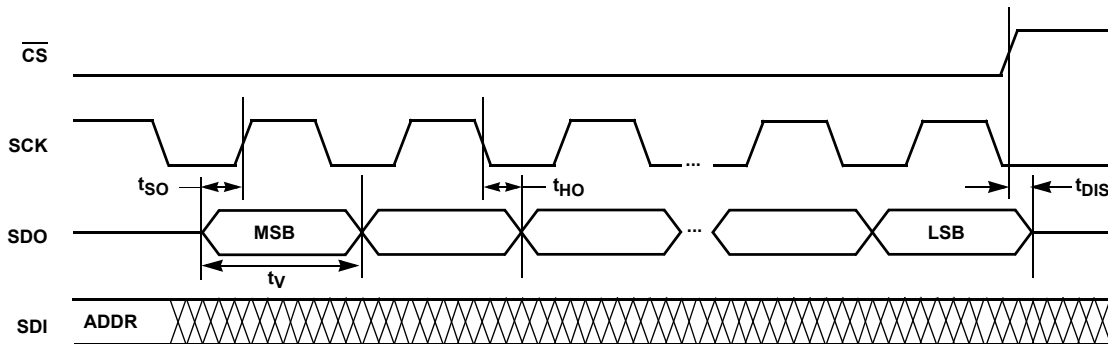

### XDCP™ Timing (for All Load Instructions)

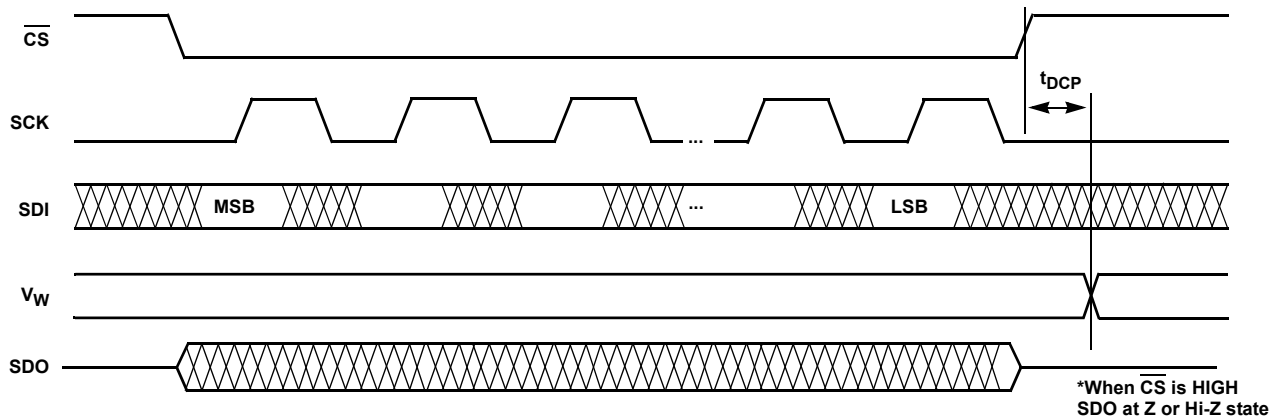



Typical Performance Curves

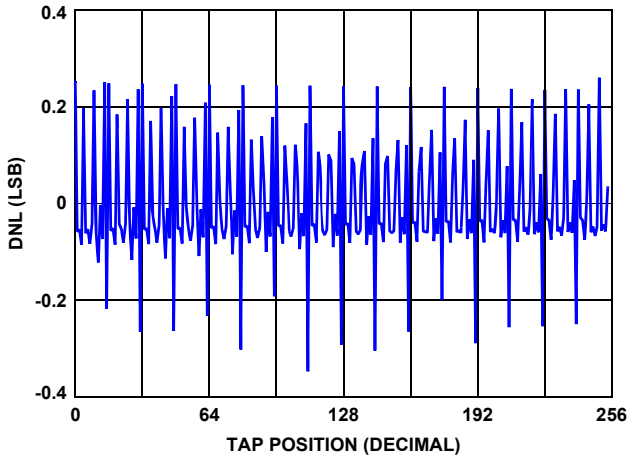

FIGURE 3. 10kΩ DNL vs TAP POSITION,  $V_{CC} = 3.3V, +25^{\circ}C$

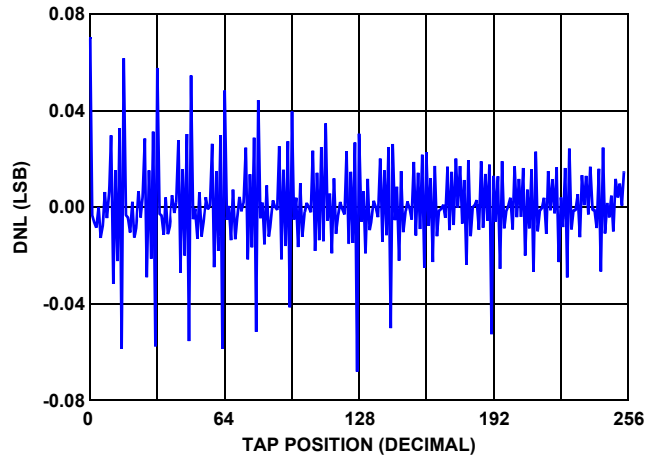

FIGURE 4. 50kΩ DNL vs TAP POSITION,  $V_{CC} = 3.3V, +25^{\circ}C$

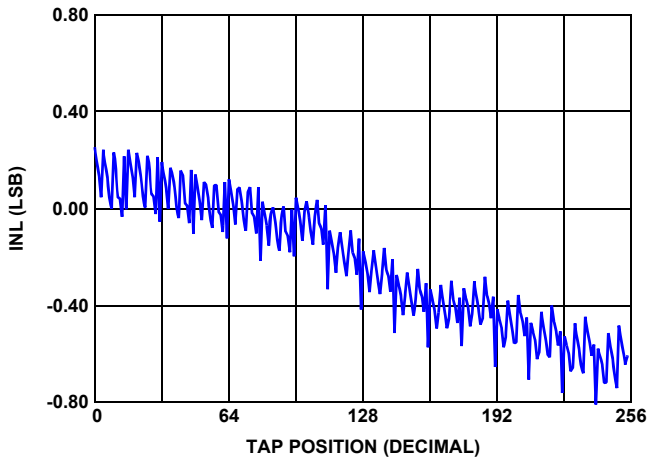

FIGURE 5. 10kΩ INL vs TAP POSITION,  $V_{CC} = 3.3V, +25^{\circ}C$

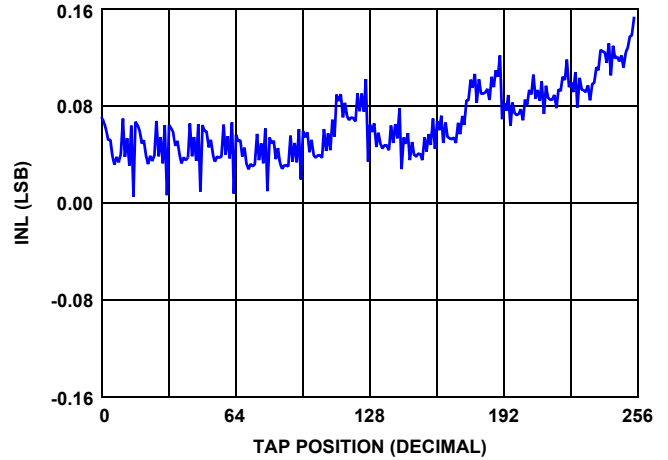

FIGURE 6. 50kΩ INL vs TAP POSITION,  $V_{CC} = 3.3V, +25^{\circ}C$

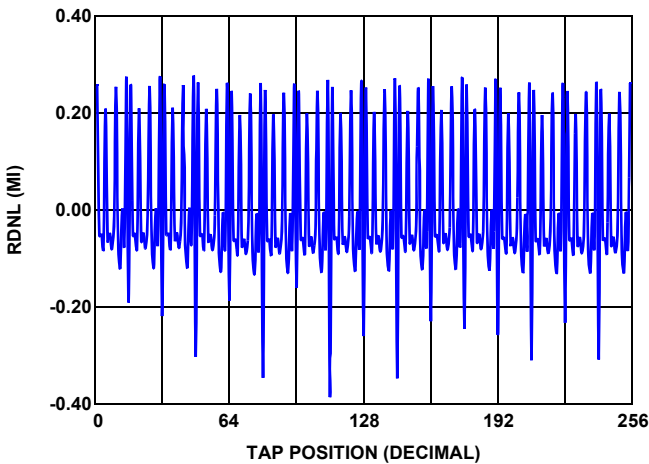

FIGURE 7. 10kΩ RDNL vs TAP POSITION,  $V_{CC} = 3.3V, +25^{\circ}C$

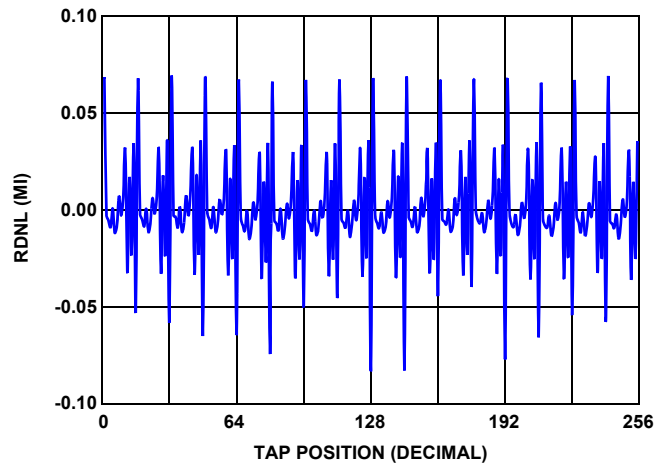

FIGURE 8. 50kΩ RDNL vs TAP POSITION,  $V_{CC} = 3.3V, +25^{\circ}C$

## Typical Performance Curves (Continued)

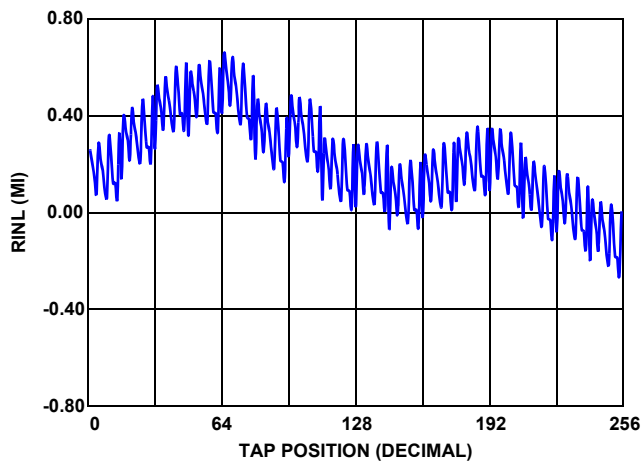

FIGURE 9. 10kΩ RINL vs TAP POSITION,  $V_{CC} = 3.3V$ ,  $+25^{\circ}C$

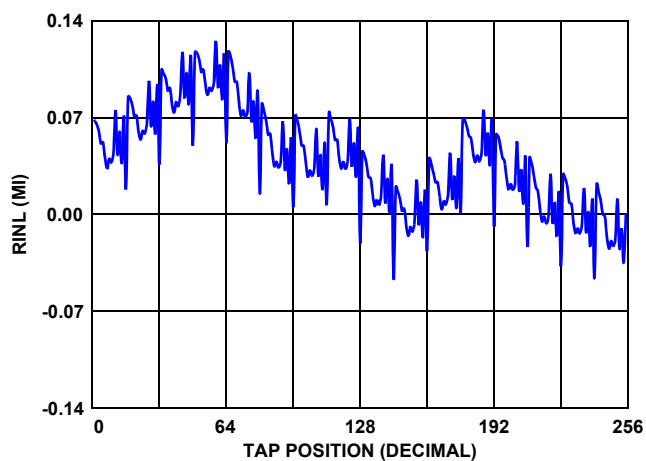

FIGURE 10. 50kΩ RINL vs TAP POSITION,  $V_{CC} = 3.3V$ ,  $+25^{\circ}C$

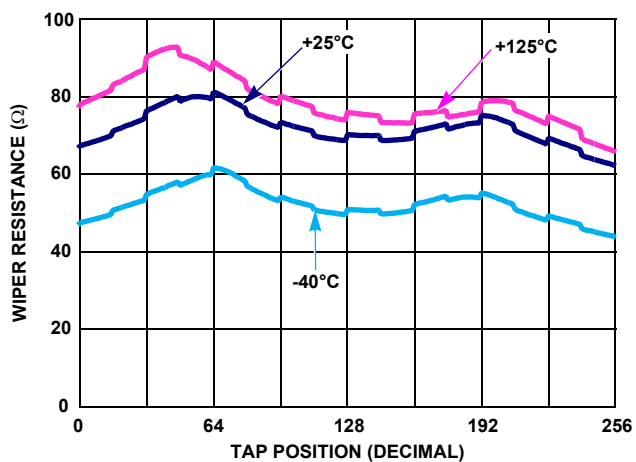

FIGURE 11. 10kΩ WIPER RESISTANCE vs TAP POSITION,  $V_{CC} = 3.3V$

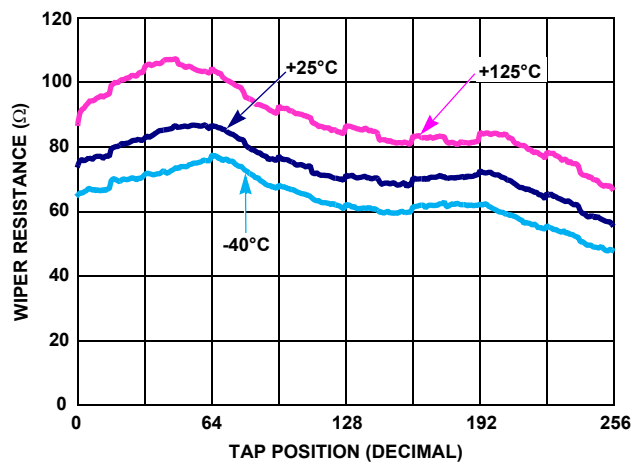

FIGURE 12. 50kΩ WIPER RESISTANCE vs TAP POSITION,  $V_{CC} = 3.3V$

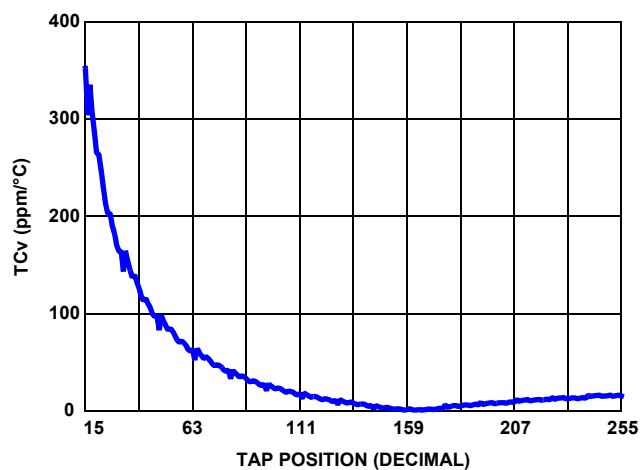

FIGURE 13. 10kΩ TCv vs TAP POSITION,  $V_{CC} = 3.3V$

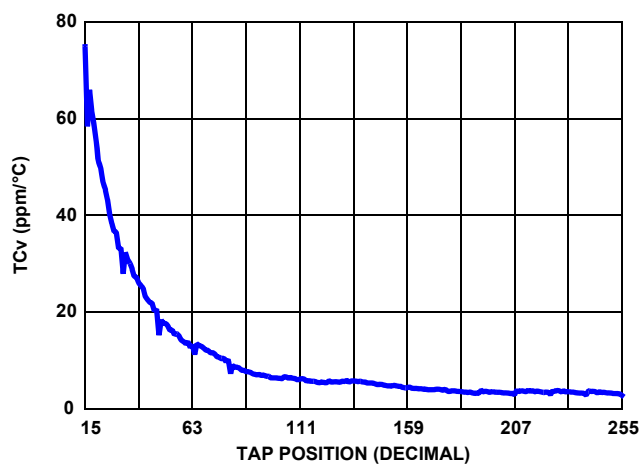

FIGURE 14. 50kΩ TCv vs TAP POSITION,  $V_{CC} = 3.3V$

## Typical Performance Curves (Continued)

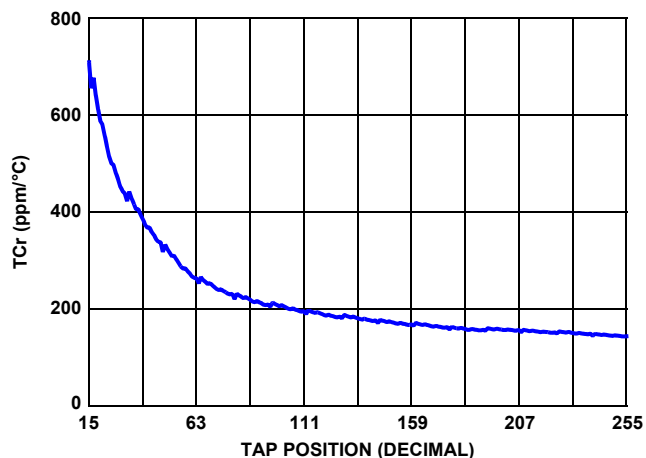

FIGURE 15. 10kΩ TCr vs TAP POSITION

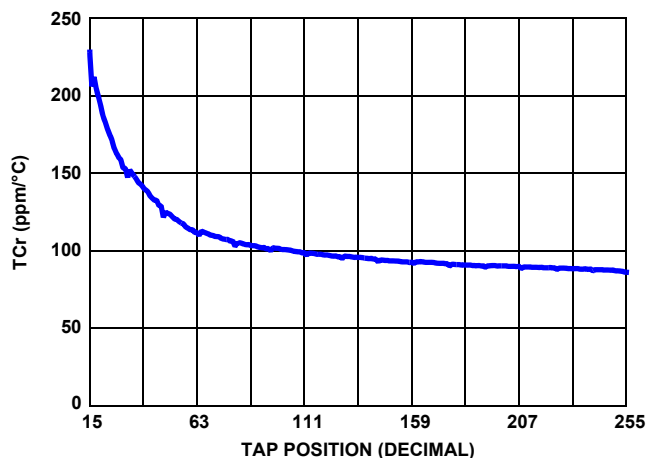

FIGURE 16. 50kΩ TCr vs TAP POSITION,  $V_{CC} = 3.3V$

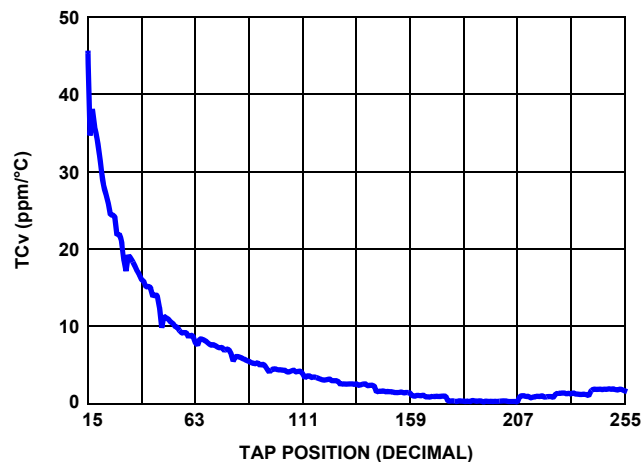

FIGURE 17. 100kΩ TCv vs TAP POSITION,  $V_{CC} = 3.3V$

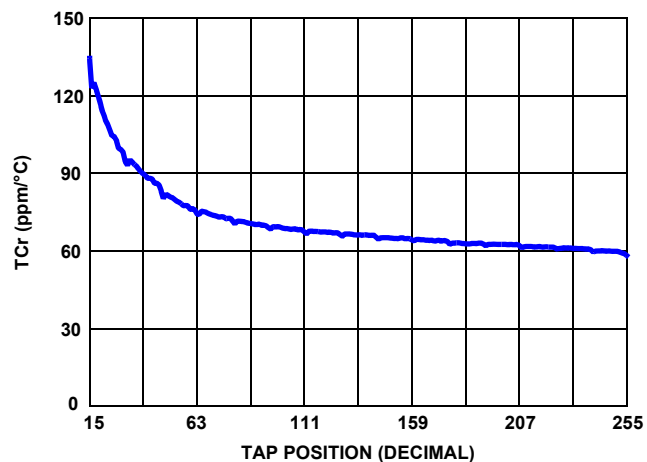

FIGURE 18. 100kΩ TCr vs TAP POSITION,  $V_{CC} = 3.3V$

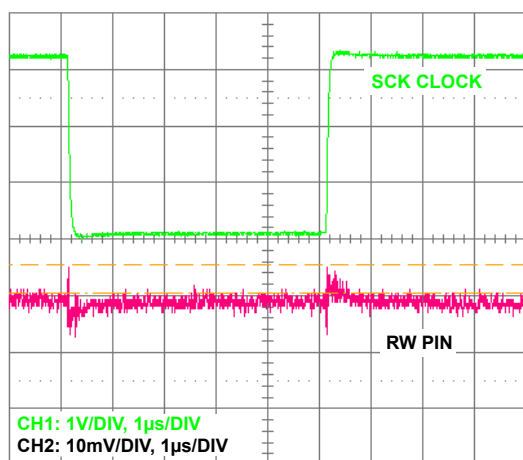

FIGURE 19. WIPER DIGITAL FEED-THROUGH

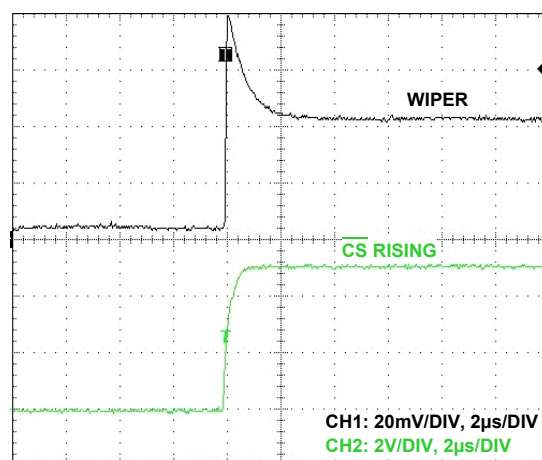

FIGURE 20. WIPER TRANSITION GLITCH

## Typical Performance Curves (Continued)

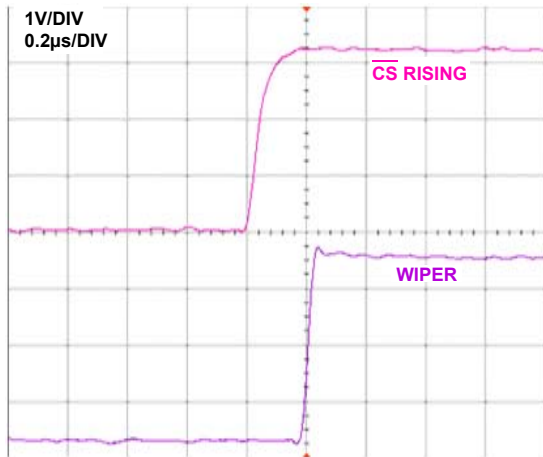

FIGURE 21. WIPER LARGE SIGNAL SETTLING TIME

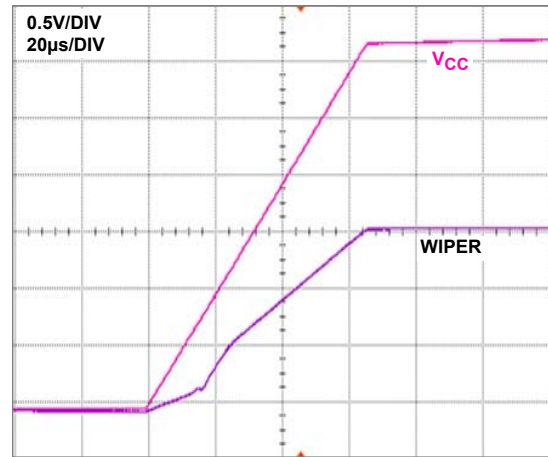

FIGURE 22. POWER-ON START-UP IN VOLTAGE DIVIDER MODE

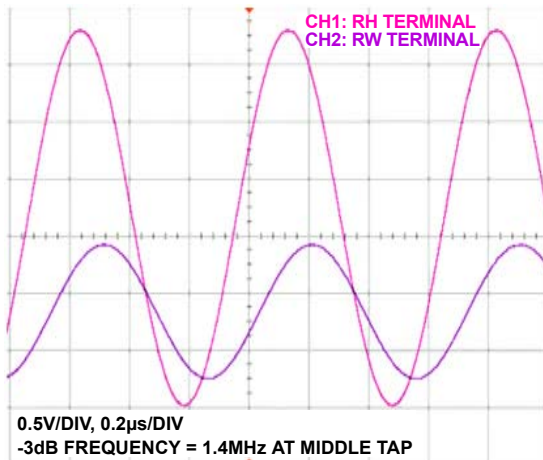

FIGURE 23. 10kΩ -3dB CUT OFF FREQUENCY

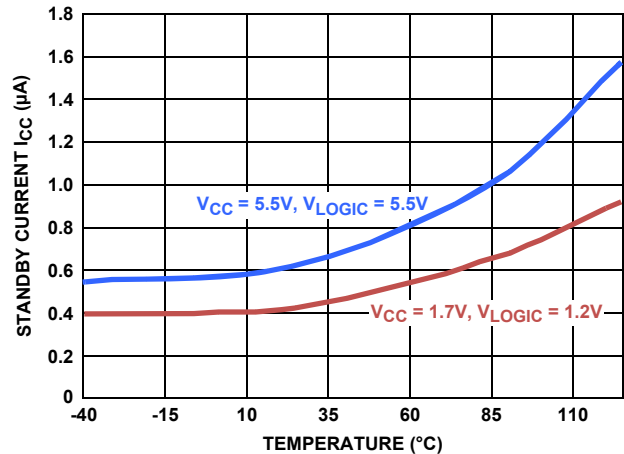

FIGURE 24. STANDBY CURRENT vs TEMPERATURE

## Functional Pin Descriptions

### Potentiometers Pins

#### RHi AND RLi

The high (RHi,  $i = 0, 1$ ) and low (RLi,  $i = 0, 1$ ) terminals of the ISL23425 are equivalent to the fixed terminals of a mechanical potentiometer. RHi and RLi are referenced to the relative position of the wiper and not the voltage potential on the terminals. With WRi set to 255 decimal, the wiper will be closest to RHi, and with the WRi set to 0, the wiper is closest to RLi.

#### RWi

RWi ( $i = 0, 1$ ) is the wiper terminal, and it is equivalent to the movable terminal of a mechanical potentiometer. The position of the wiper within the array is determined by the WRi register.

### Power Pins

#### VCC

Power terminal for the potentiometer section analog power source. Can be any value needed to support voltage range of DCP pins, from 1.7V to 5.5V, independent of the VLOGIC voltage.

### Bus Interface Pins

#### SERIAL CLOCK (SCK)

This input is the serial clock of the SPI serial interface.

#### SERIAL DATA INPUT (SDI)

The SDI is a serial data input pin for SPI interface. It receives operation code, wiper address and data from the SPI remote host device. The data bits are shifted in at the rising edge of the serial clock SCK, while the CS input is low.

## SERIAL DATA OUTPUT (SDO)

The SDO is a serial data output pin. During a read cycle, the data bits are shifted out on the falling edge of the serial clock SCK and will be available to the master on the following rising edge of SCK.

The output type is configured through ACR[1] bit for Push-Pull or Open Drain operation. Default setting for this pin is Push-Pull. An external pull-up resistor is required for Open Drain output operation. When  $\overline{CS}$  is HIGH, the SDO pin is in tri-state (Z) or high-tri-state (Hi-Z) depends on the selected configuration.

## CHIP SELECT ( $\overline{CS}$ )

$\overline{CS}$  LOW enables the ISL23425, placing it in the active power mode. A HIGH to LOW transition on  $\overline{CS}$  is required prior to the start of any operation after power-up. When  $\overline{CS}$  is HIGH, the ISL23425 is deselected and the SDO pin is at high impedance, and the device will be in the standby state.

## V<sub>LOGIC</sub>

Digital power source for the logic control section. It supplies an internal level translator for 1.2V to 5.5V serial bus operation. Use the same supply as the I<sup>2</sup>C logic source.

## Principles of Operation

The ISL23425 is an integrated circuit incorporating two DCPs with its associated registers and an SPI serial interface providing direct communication between a host and the potentiometer. The resistor array is comprised of individual resistors connected in series. At either end of the array and between each resistor is an electronic switch that transfers the potential at that point to the wiper.

The electronic switches on the device operate in a “make-before-break” mode when the wiper changes tap positions.

Voltage at any DCP pins, RHi, RLi or RWi, should not exceed V<sub>CC</sub> level at any conditions during power-up and normal operation.

The V<sub>LOGIC</sub> pin is the terminal for the logic control digital power source. It should use the same supply as the SPI logic source which allows reliable communication with a wide range of microcontrollers and is independent from the V<sub>CC</sub> level. This is extremely important in systems where the master supply has lower levels than DCP analog supply.

## DCP Description

Each DCP is implemented with a combination of resistor elements and CMOS switches. The physical ends of each DCP are equivalent to the fixed terminals of a mechanical potentiometer (RHi and RLi pins). The RWi pin of the DCP is connected to intermediate nodes, and is equivalent to the wiper terminal of a mechanical potentiometer. The position of the wiper terminal within the DCP is controlled by an 8-bit volatile Wiper Register (WRi). When the WR of a DCP contains all zeroes (WRi[7:0] = 00h), its wiper terminal (RWi) is closest to its “Low” terminal (RLi). When the WRi register of a DCP contains all ones (WRi[7:0] = FFh), its wiper terminal (RWi) is closest to its “High” terminal (RHi). As the value of the WRi increases from all zeroes (0) to all ones (255 decimal), the wiper moves monotonically from the position closest to RLi to the position closest to RHi. At

the same time, the resistance between RWi and RLi increases monotonically, while the resistance between RHi and RWi decreases monotonically.

While the ISL23425 is being powered up, both WRi are reset to 80h (128 decimal), which positions RWi at the center between RLi and RHi.

The WRi can be read or written to directly using the SPI serial interface as described in the following sections.

## Memory Description

The ISL23425 contains three volatile 8-bit registers: Wiper Register WRO, Wiper Register WR1, and Access Control Register (ACR). Memory map of ISL23425 is shown in Table 1. The Wiper Register WRO at address 0, contains current wiper position of DCP0; The Wiper Register WR1 at address 1 contains current wiper position of DCP1. The Access Control Register (ACR) at address 10h contains information and control bits described in Table 2.

TABLE 1. MEMORY MAP

ADDRESS (hex)	VOLATILE REGISTER NAME	DEFAULT SETTING (hex)
10	ACR	40
1	WR1	80
0	WRO	80

TABLE 2. ACCESS CONTROL REGISTER (ACR)

BIT #	7	6	5	4	3	2	1	0
NAME/VALUE	0	$\overline{SHDN}$	0	0	0	0	SDO	0

The SDO bit (ACR[1]) configures type of SDO output pin. The default value of SDO bit is 0 for Push-Pull output. The SDO pin can be configured as Open Drain output for some applications. In this case, an external pull-up resistor is required, reference the “Serial Interface Specification” on page 6.

## Shutdown Function

The  $\overline{SHDN}$  bit (ACR[6]) disables or enables shutdown mode for all DCP channels simultaneously. When this bit is 0, i.e., each DCP is forced to end-to-end open circuit and each RW shorted to RL through a 2k $\Omega$  serial resistor as shown in Figure 25. Default value of the  $\overline{SHDN}$  bit is 1.

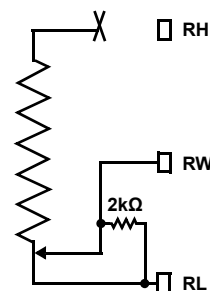

FIGURE 25. DCP CONNECTION IN SHUTDOWN MODE

When the device enters shutdown, all current DCP WR settings are maintained. When the device exits shutdown, the wipers will return to the previous WR settings after a short settling time (see Figure 26).

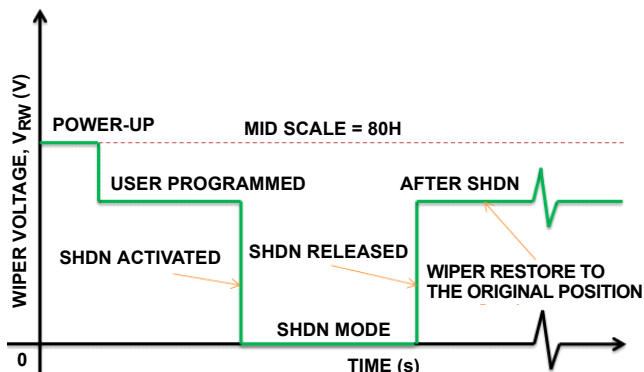

FIGURE 26. SHUTDOWN MODE WIPER RESPONSE

## SPI Serial Interface

The ISL23425 supports an SPI serial protocol, mode 0. The device is accessed via the SDI input and SDO output with data clocked in on the rising edge of SCK, and clocked out on the falling edge of SCK.  $\overline{CS}$  must be LOW during communication with the ISL23425. The SCK and  $\overline{CS}$  lines are controlled by the host or master. The ISL23425 operates only as a slave device.

All communication over the SPI interface is conducted by sending the MSB of each byte of data first.

## Protocol Conventions

The SPI protocol contains Instruction Byte followed by one or more Data Bytes. A valid Instruction Byte contains instruction as the three MSBs, with the following five register address bits (see Table 3).

The next byte sent to the ISL23425 is the Data Byte.

TABLE 3. INSTRUCTION BYTE FORMAT

BIT #	7	6	5	4	3	2	1	0
	I2	I1	I0	R4	R3	R2	R1	R0

Table 4 contains a valid instruction set for ISL23425.

If the [R4:R0] bits are zero or one, then the read or write is to the WR<sub>i</sub> register. If the [R4:R0] are 10000, then the operation is to the ACR.

TABLE 4. INSTRUCTION SET

INSTRUCTION SET								OPERATION
I2	I1	I0	R4	R3	R2	R1	R0	
0	0	0	X	X	X	X	X	NOP
0	0	1	X	X	X	X	X	ACR READ
0	1	1	X	X	X	X	X	ACR WRTE
1	0	0	R4	R3	R2	R1	R0	WR <sub>i</sub> or ACR READ
1	1	0	R4	R3	R2	R1	R0	WR <sub>i</sub> or ACR WRTE

Where X means "do not care".

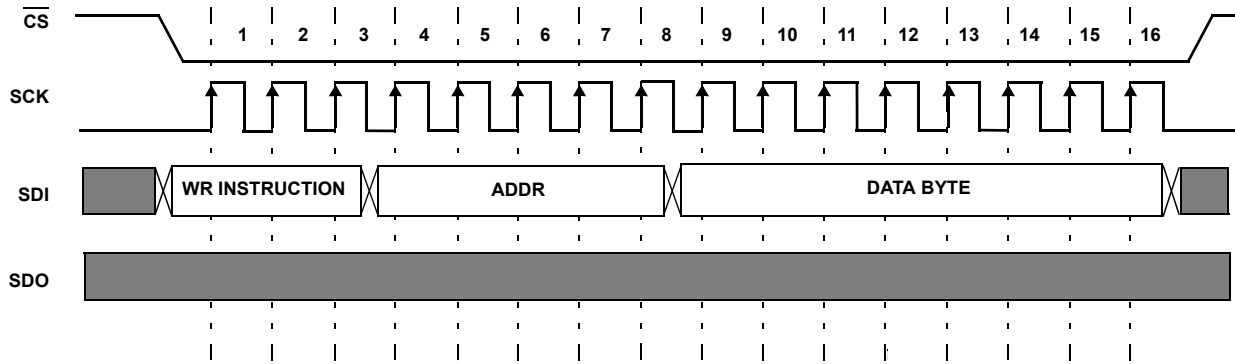

FIGURE 27. TWO BYTE WRITE SEQUENCE

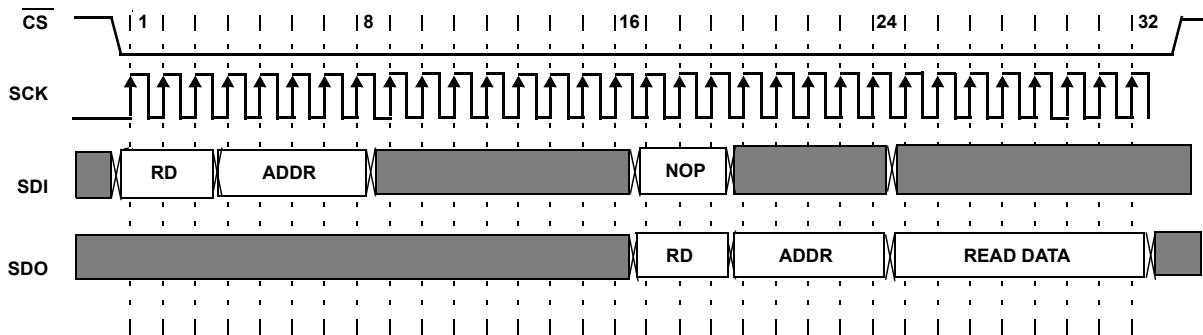

FIGURE 28. FOUR BYTE READ SEQUENCE

## Write Operation

A write operation to the ISL23425 is a two or more bytes operation. It requires first, the  $\overline{CS}$  transition from HIGH-to-LOW. Then the host sends a valid Instruction Byte, followed by one or more Data Bytes to the SDI pin. The host terminates the write operation by pulling the  $\overline{CS}$  pin from LOW-to-HIGH. Instruction is executed on the rising edge of  $\overline{CS}$  (see Figure 27).

## Read Operation

A Read operation to the ISL23425 is a four byte operation. It requires first, the  $\overline{CS}$  transition from HIGH-to-LOW. Then the host sends a valid Instruction Byte, followed by a “dummy” Data Byte, NOP Instruction Byte and another “dummy” Data Byte to SDI pin. The SPI host receives the Instruction Byte (instruction code + register address) and requested Data Byte from SDO pin on the rising edge of SCK during third and fourth bytes, respectively. The host terminates the read by pulling the  $\overline{CS}$  pin from LOW-to-HIGH (see Figure 28).

## Applications Information

### Communicating with ISL23425

Communication with ISL23425 proceeds using SPI interface through the ACR (address 10000b), WR0 (addresses 00000b) and WR1 (addresses 00001b) registers.

The wiper of the potentiometer is controlled by the WRi register. Writes and reads can be made directly to these registers to control and monitor the wiper position.

### Daisy Chain Configuration

When an application needs more than one ISL23425, it can communicate with all of them without additional  $\overline{CS}$  lines by daisy chaining the DCPs as shown in Figure 29. In Daisy Chain configuration, the SDO pin of the previous chip is connected to the SDI pin of the following chip, and each  $\overline{CS}$  and SCK pins are connected to the corresponding microcontroller pins in parallel, like regular SPI interface implementation. The Daisy Chain configuration can also be used for simultaneous setting of multiple DCPs. Note, the number of daisy chained DCPs is limited only by the driving capabilities of the SCK and  $\overline{CS}$  pins of the microcontroller; for larger number of SPI devices buffering of SCK and  $\overline{CS}$  lines is required.

### Daisy Chain Write Operation

The write operation starts by HIGH-to-LOW transition on  $\overline{CS}$  line, followed by N number of two bytes write instructions on SDI line with reversed chain access sequence: the instruction byte + data byte for the last DCP in chain is going first, as shown in Figure 30, where N is a number of DCPs in chain. The serial data is going through DCPs from DCP0 to DCP(N-1) as follow: DCP0 → DCP1 → DCP2 → ... → DCP(N-1). The write instruction is executed on the rising edge of  $\overline{CS}$  for all N DCPs simultaneously.

### Daisy Chain Read Operation

The read operation consists of two parts: first, send the read instructions (N two bytes operation) with valid address; second, read the requested data while sending NOP instructions (N two bytes operation) as shown in Figures 31 and 32.

The first part starts by HIGH-to-LOW transition on  $\overline{CS}$  line, followed by N two bytes read instruction on SDI line with reversed chain access sequence: the instruction byte + dummy data byte for the last DCP in chain is going first, followed by LOW-to-HIGH transition on  $\overline{CS}$  line. The read instructions are executed during the second part of read sequence. It also starts by HIGH-to-LOW transition on  $\overline{CS}$  line, followed by N number of two bytes NOP instructions on SDI line and LOW-to-HIGH transition of  $\overline{CS}$ . The data is read on every even byte during the second part of the read sequence while every odd byte contains code 111b followed by address from which the data is being read.

### Wiper Transition

When stepping up through each tap in voltage divider mode, some tap transition points can result in noticeable voltage transients, or overshoot/undershoot, resulting from the sudden transition from a very low impedance “make” to a much higher impedance “break” within a short period of time ( $<1\mu\text{s}$ ). There are several code transitions such as 0Fh to 10h, 1Fh to 20h, ..., EFh to FFh, which have higher transient glitch. Note that all switching transients will settle well within the settling time as stated in the datasheet. A small capacitor can be added externally to reduce the amplitude of these voltage transients, but that will also reduce the useful bandwidth of the circuit, thus may not be a good solution for some applications. It may be a good idea, in that case, to use fast amplifiers in a signal chain for fast recovery.

### V<sub>LOGIC</sub> Requirements

It is recommended to keep V<sub>LOGIC</sub> powered all the time during normal operation. In a case where turning V<sub>LOGIC</sub> OFF is necessary, it is recommended to ground the V<sub>LOGIC</sub> pin of the ISL23425. Grounding the V<sub>LOGIC</sub> pin or both V<sub>LOGIC</sub> and V<sub>CC</sub> does not affect other devices on the same bus. It is good practice to put a 1 $\mu\text{F}$  capacitor in parallel with 0.1 $\mu\text{F}$  decoupling capacitor close to the V<sub>LOGIC</sub> pin.

### V<sub>CC</sub> Requirements and Placement

It is recommended to put a 1 $\mu\text{F}$  capacitor in parallel with 0.1 $\mu\text{F}$  decoupling capacitor close to the V<sub>CC</sub> pin.

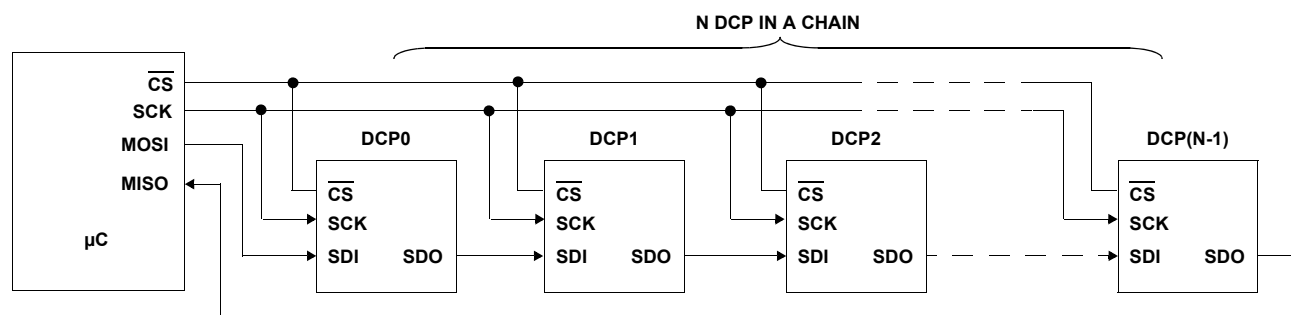

FIGURE 29. DAISY CHAIN CONFIGURATION



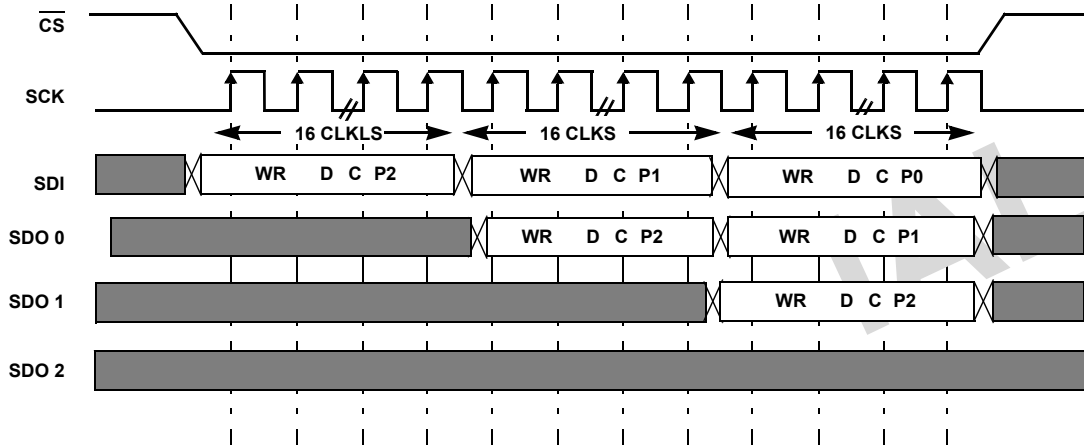

FIGURE 30. DAISY CHAIN WRITE SEQUENCE OF N = 3 DCP

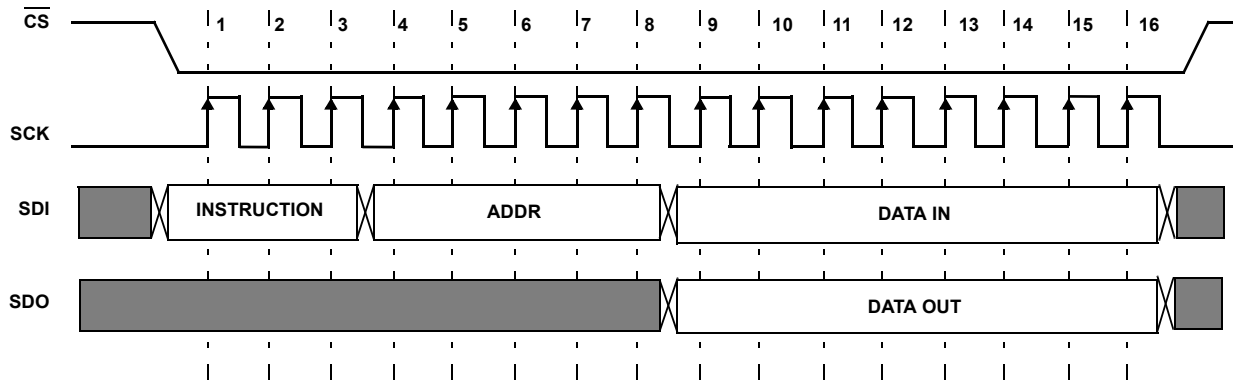

FIGURE 31. TWO BYTE READ INSTRUCTION

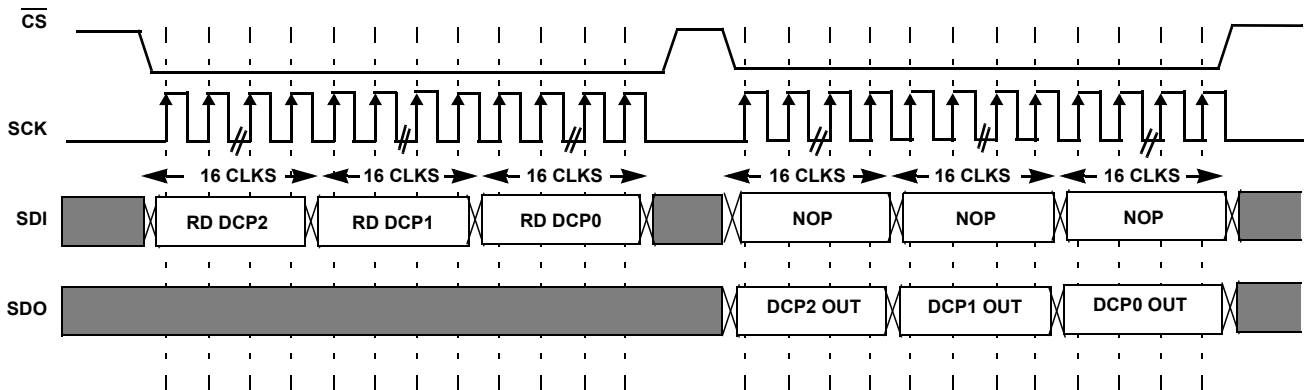

FIGURE 32. DAISY CHAIN READ SEQUENCE OF N = 3 DCP

## Revision History

The revision history provided is for informational purposes only and is believed to be accurate, but not warranted. Please go to web to make sure you have the latest Rev.

DATE	REVISION	CHANGE
6/20/11	FN7873.0	Initial Release.

## Products

Intersil Corporation is a leader in the design and manufacture of high-performance analog semiconductors. The Company's products address some of the industry's fastest growing markets, such as, flat panel displays, cell phones, handheld products, and notebooks. Intersil's product families address power management and analog signal processing functions. Go to [www.intersil.com/products](http://www.intersil.com/products) for a complete list of Intersil product families.

\*For a complete listing of Applications, Related Documentation and Related Parts, please see the respective device information page on intersil.com: [ISL23425](http://www.intersil.com/ISL23425)

To report errors or suggestions for this datasheet, please go to [www.intersil.com/askourstaff](http://www.intersil.com/askourstaff)

FITs are available from our website at <http://rel.intersil.com/reports/search.php>

For additional products, see [www.intersil.com/product\\_tree](http://www.intersil.com/product_tree)

Intersil products are manufactured, assembled and tested utilizing ISO9000 quality systems as noted in the quality certifications found at [www.intersil.com/design/quality](http://www.intersil.com/design/quality)

*Intersil products are sold by description only. Intersil Corporation reserves the right to make changes in circuit design, software and/or specifications at any time without notice. Accordingly, the reader is cautioned to verify that data sheets are current before placing orders. Information furnished by Intersil is believed to be accurate and reliable. However, no responsibility is assumed by Intersil or its subsidiaries for its use; nor for any infringements of patents or other rights of third parties which may result from its use. No license is granted by implication or otherwise under any patent or patent rights of Intersil or its subsidiaries.*

For information regarding Intersil Corporation and its products, see [www.intersil.com](http://www.intersil.com)

## Package Outline Drawing

### M14.173

14 LEAD THIN SHRINK SMALL OUTLINE PACKAGE (TSSOP)

Rev 3, 10/09

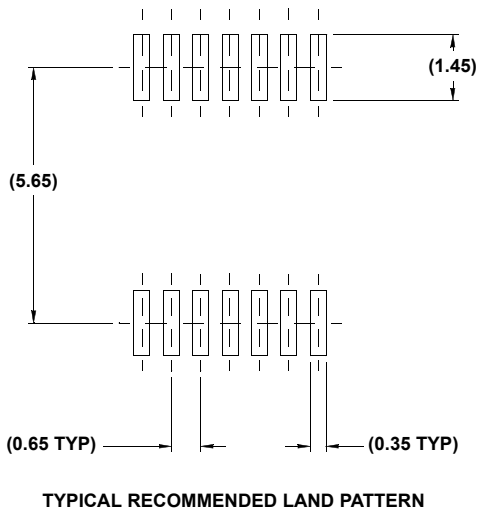
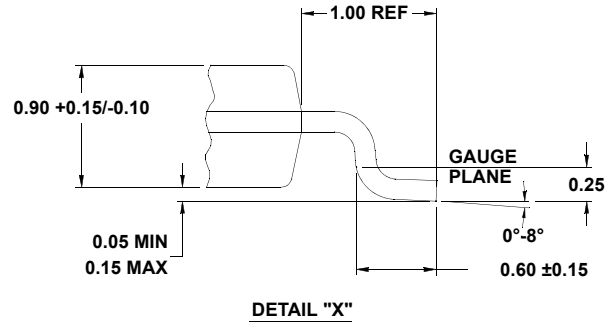
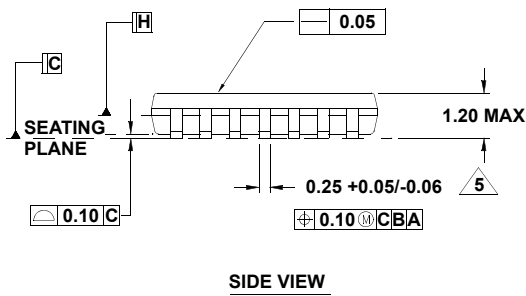
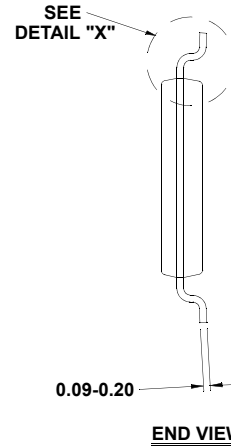
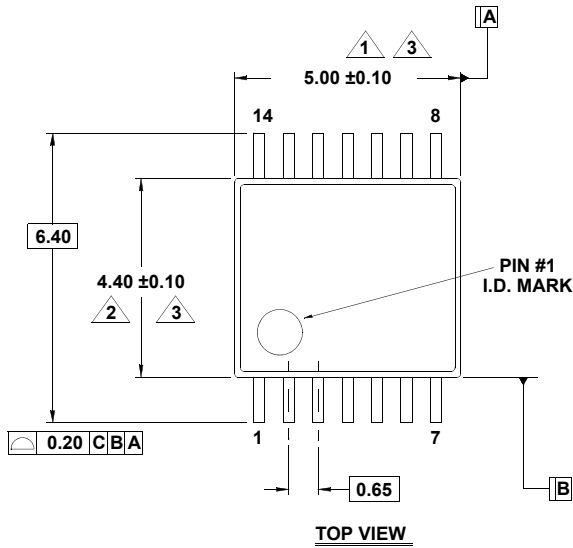

#### NOTES:

1. Dimension does not include mold flash, protrusions or gate burrs. Mold flash, protrusions or gate burrs shall not exceed 0.15 per side.
2. Dimension does not include interlead flash or protrusion. Interlead flash or protrusion shall not exceed 0.25 per side.
3. Dimensions are measured at datum plane H.
4. Dimensioning and tolerancing per ASME Y14.5M-1994.
5. Dimension does not include dambar protrusion. Allowable protrusion shall be 0.80mm total in excess of dimension at maximum material condition. Minimum space between protrusion and adjacent lead is 0.07mm.
6. Dimension in ( ) are for reference only.
7. Conforms to JEDEC MO-153, variation AB-1.

# ISL23425

## Ultra Thin Quad Flat No-Lead Plastic Package (UTQFN)

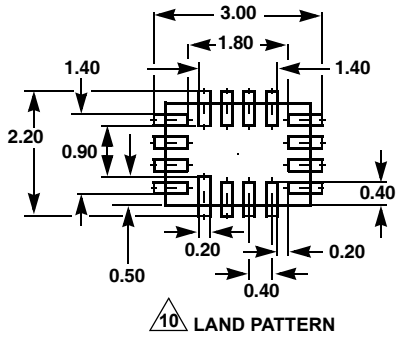
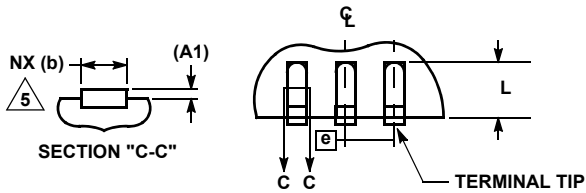
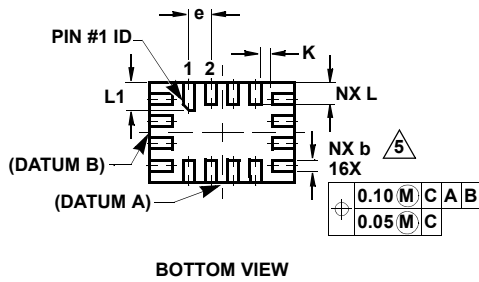
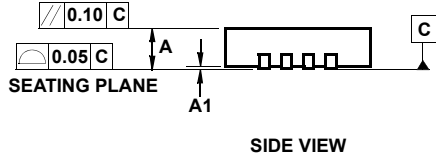
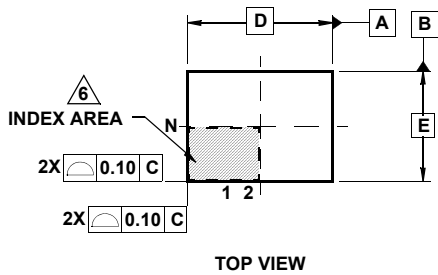

### L16.2.6x1.8A

#### 16 LEAD ULTRA THIN QUAD FLAT NO-LEAD PLASTIC PACKAGE

SYMBOL	MILLIMETERS			NOTES
	MIN	NOMINAL	MAX	
A	0.45	0.50	0.55	-
A1	-	-	0.05	-
A3	0.127 REF			-
b	0.15	0.20	0.25	5
D	2.55	2.60	2.65	-
E	1.75	1.80	1.85	-
e	0.40 BSC			-
K	0.15	-	-	-
L	0.35	0.40	0.45	-
L1	0.45	0.50	0.55	-
N	16			2
Nd	4			3
Ne	4			3
θ	0	-	12	4

Rev. 5 2/09

#### NOTES:

1. Dimensioning and tolerancing conform to ASME Y14.5-1994.
2. N is the number of terminals.
3. Nd and Ne refer to the number of terminals on D and E side, respectively.
4. All dimensions are in millimeters. Angles are in degrees.
5. Dimension b applies to the metallized terminal and is measured between 0.15mm and 0.30mm from the terminal tip.
6. The configuration of the pin #1 identifier is optional, but must be located within the zone indicated. The pin #1 identifier may be either a mold or mark feature.
7. Maximum package warpage is 0.05mm.
8. Maximum allowable burrs is 0.076mm in all directions.
9. JEDEC Reference MO-255.
10. For additional information, to assist with the PCB Land Pattern Design effort, see Intersil Technical Brief TB389.