

Single Cell Lithium-Ion Charge Management Controller

Features

- Linear Charge Management Controller for Single Lithium-Ion Cells
- High Accuracy Preset Voltage Regulation: $\pm 1\%$ (max)
- Two Preset Voltage Regulation Options:
 - 4.1V - MCP73826-4.1
 - 4.2V - MCP73826-4.2
- Programmable Charge Current
- Automatic Cell Preconditioning of Deeply Depleted Cells, Minimizing Heat Dissipation During Initial Charge Cycle
- Automatic Power-Down when Input Power Removed
- Temperature Range: -20°C to $+85^{\circ}\text{C}$
- Packaging: 6-Pin SOT-23A

Applications

- Single Cell Lithium-Ion Battery Chargers
- Personal Data Assistants
- Cellular Telephones
- Hand Held Instruments
- Cradle Chargers
- Digital Cameras

Typical Application Circuit

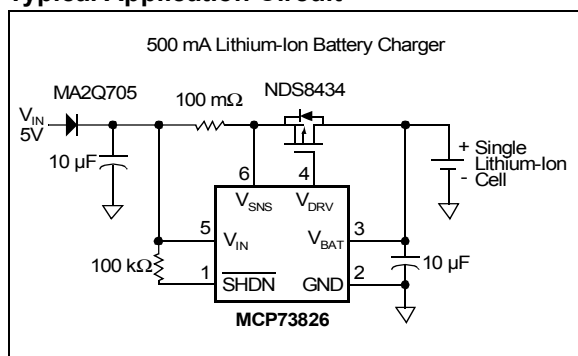

Description

The MCP73826 is a linear charge management controller for use in space-limited, cost sensitive applications. The MCP73826 combines high accuracy constant voltage, controlled current regulation, and cell preconditioning in a space saving 6-pin SOT-23A package. The MCP73826 provides a stand-alone charge management solution.

The MCP73826 charges the battery in three phases: preconditioning, controlled current, and constant voltage. If the battery voltage is below the internal low-voltage threshold, the battery is preconditioned with a foldback current. The preconditioning phase protects the lithium-ion cell and minimizes heat dissipation.

Following the preconditioning phase, the MCP73826 enters the controlled current phase. The MCP73826 allows for design flexibility with a programmable charge current set by an external sense resistor. The charge current is ramped up, based on the cell voltage, from the foldback current to the peak charge current established by the sense resistor. This phase is maintained until the battery reaches the charge-regulation voltage.

Then, the MCP73826 enters the final phase, constant voltage. The accuracy of the voltage regulation is better than $\pm 1\%$ over the entire operating temperature range and supply voltage range. The MCP73826-4.1 is preset to a regulation voltage of 4.1V, while the MCP73826-4.2 is preset to 4.2V.

The MCP73826 operates with an input voltage range from 4.5V to 5.5V. The MCP73826 is fully specified over the ambient temperature range of -20°C to $+85^{\circ}\text{C}$.

Package Type

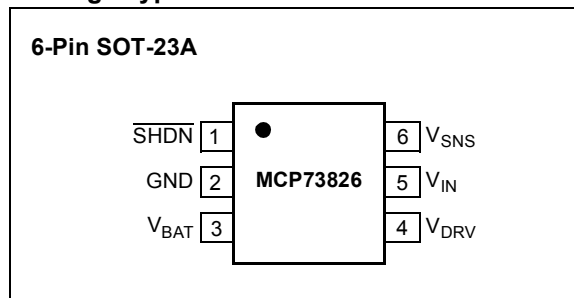

MCP73826

Functional Block Diagram

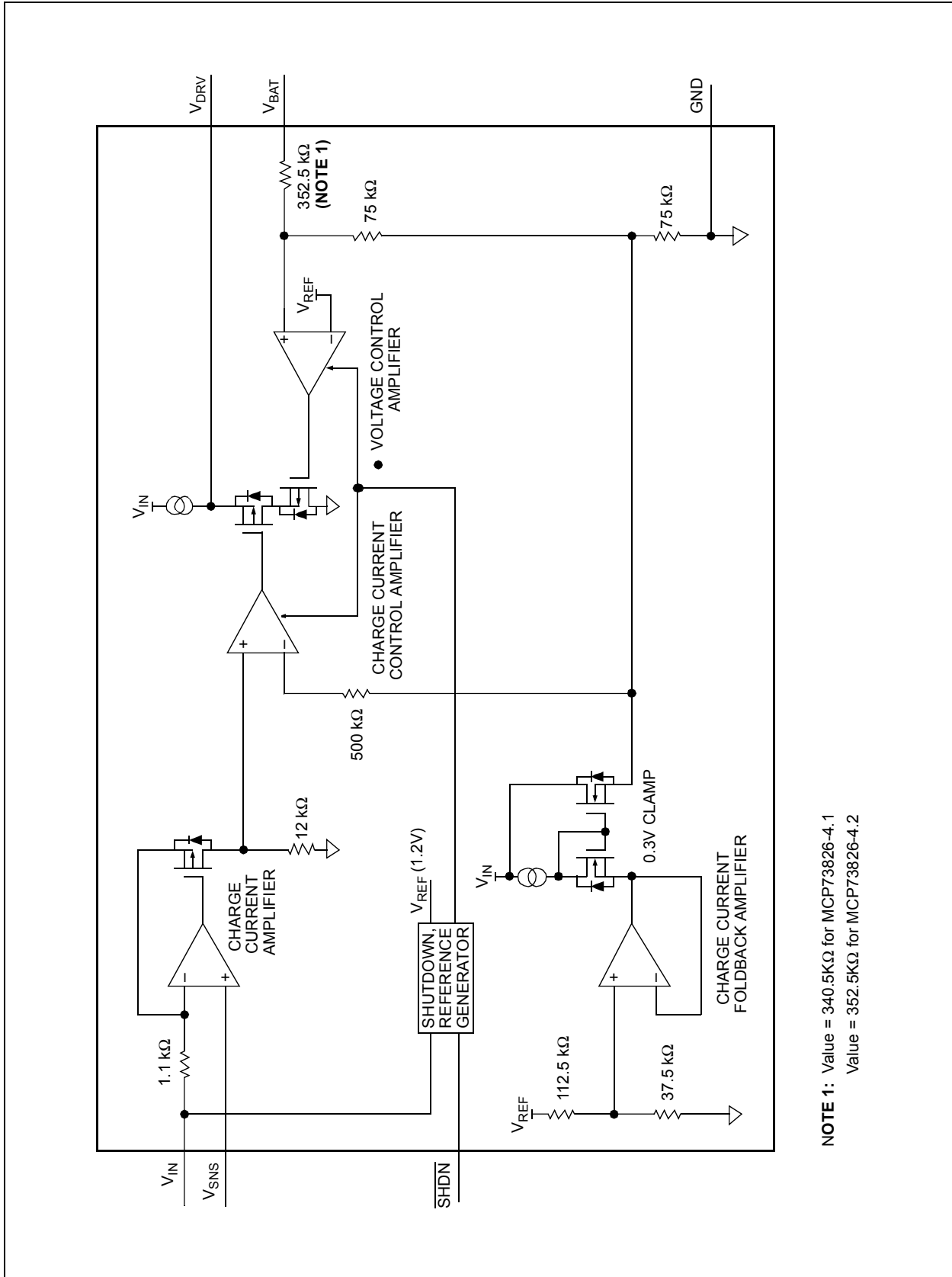

NOTE 1: Value = $340.5\text{ k}\Omega$ for MCP73826-4.1
 Value = $352.5\text{ k}\Omega$ for MCP73826-4.2

1.0 ELECTRICAL CHARACTERISTICS

1.1 Maximum Ratings*

V_{IN} -0.3V to 6.0V
 All inputs and outputs w.r.t. GND -0.3 to $(V_{IN}+0.3)V$
 Current at V_{DRV} +/-1 mA
 Maximum Junction Temperature, T_J 150°C
 Storage temperature -65°C to +150°C
 ESD protection on all pins ≥ 4 kV

***Notice:** Stresses above those listed under “Maximum Ratings” may cause permanent damage to the device. This is a stress rating only and functional operation of the device at those or any other conditions above those indicated in the operational listings of this specification is not implied. Exposure to maximum rating conditions for extended periods may affect device reliability.

PIN FUNCTION TABLE

Pin	Name	Description
1	$\overline{\text{SHDN}}$	Logic Shutdown
2	GND	Battery Management 0V Reference
3	V_{BAT}	Cell Voltage Monitor Input
4	V_{DRV}	Drive Output
5	V_{IN}	Battery Management Input Supply
6	V_{SNS}	Charge Current Sense Input

DC CHARACTERISTICS: MCP73826-4.1, MCP73826-4.2

Unless otherwise specified, all limits apply for $V_{IN} = [V_{REG}(typ)+1V]$, $R_{SENSE} = 500$ m Ω , $T_A = -20^\circ\text{C}$ to $+85^\circ\text{C}$. Typical values are at $+25^\circ\text{C}$. Refer to Figure 1-1 for test circuit.

Parameter	Sym	Min	Typ	Max	Units	Conditions
Supply Voltage	V_{IN}	4.5	—	5.5	V	
Supply Current	I_{IN}	—	0.5 260	15 560	μA	Shutdown, $V_{SHDN} = 0V$ Constant Voltage Mode
Voltage Regulation (Constant Voltage Mode)						
Regulated Output Voltage	V_{REG}	4.059 4.158	4.1 4.2	4.141 4.242	V V	MCP73826-4.1 only MCP73826-4.2 only
Line Regulation	ΔV_{BAT}	-10	—	10	mV	$V_{IN} = 4.5V$ to $5.5V$, $I_{OUT} = 75$ mA
Load Regulation	ΔV_{BAT}	-1	± 0.2	1	mV	$I_{OUT} = 10$ mA to 75 mA
Output Reverse Leakage Current	I_{LK}	—	8	—	μA	$V_{IN} = \text{Floating}$, $V_{BAT} = V_{REG}$
External MOSFET Gate Drive						
Gate Drive Current	I_{DRV}	— 0.08	— —	1 —	mA mA	Sink, CV Mode Source, CV Mode
Gate Drive Minimum Voltage	V_{DRV}	—	1.6	—	V	
Current Regulation (Controlled Current Mode)						
Current Sense Gain	A_{CS}	—	100	—	dB	$\Delta(V_{SNS}-V_{DRV}) / \Delta V_{BAT}$
Current Limit Threshold	V_{CS}	40	53	75	mV	$(V_{IN}-V_{SNS})$ at I_{OUT}
Foldback Current Scale Factor	K	—	0.43	—	A/A	
Shutdown Input - SHDN						
Input High Voltage Level	V_{IH}	40	—	—	$\%V_{IN}$	
Input Low Voltage Level	V_{IL}	—	—	25	$\%V_{IN}$	
Input Leakage Current	I_{LK}	—	—	1	μA	$V_{SHDN} = 0V$ to $5.5V$

TEMPERATURE SPECIFICATIONS

Unless otherwise specified, all limits apply for $V_{IN} = 4.5V-5.5V$

Parameters	Sym	Min	Typ	Max	Units	Conditions
Temperature Ranges						
Specified Temperature Range	T_A	-20	—	+85	$^\circ\text{C}$	
Operating Temperature Range	T_A	-40	—	+125	$^\circ\text{C}$	
Storage Temperature Range	T_A	-65	—	+150	$^\circ\text{C}$	
Thermal Package Resistances						
Thermal Resistance, 6-Pin SOT-23A	θ_{JA}	—	230	—	$^\circ\text{C/W}$	4-Layer JC51-7 Standard Board, Natural Convection

MCP73826

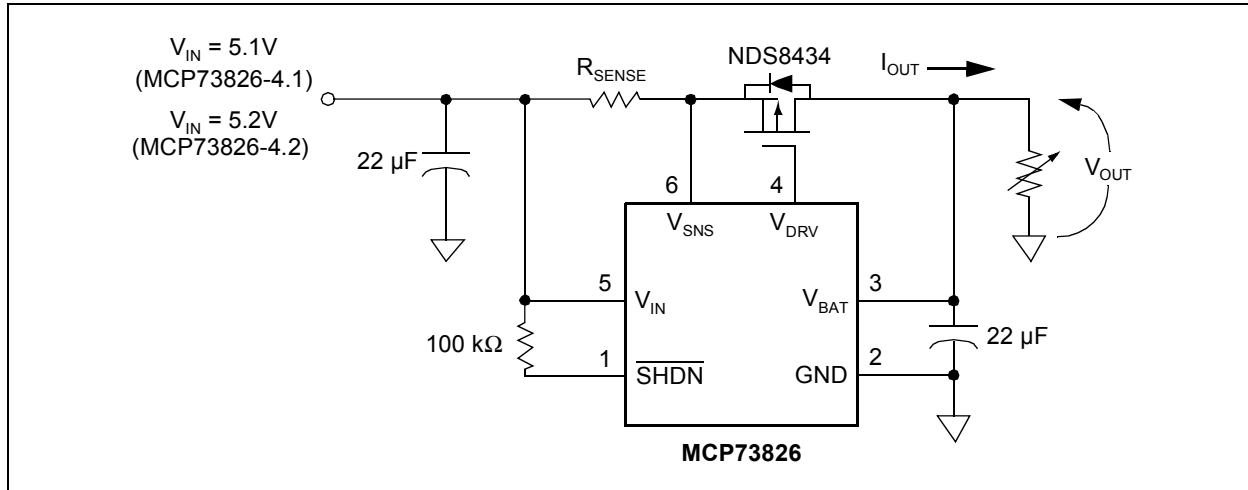

FIGURE 1-1: MCP73826 Test Circuit.

2.0 TYPICAL PERFORMANCE CHARACTERISTICS

Note: The graphs and tables provided following this note are a statistical summary based on a limited number of samples and are provided for informational purposes only. The performance characteristics listed herein are not tested or guaranteed. In some graphs or tables, the data presented may be outside the specified operating range (e.g., outside specified power supply range) and therefore outside the warranted range.

Note: Unless otherwise indicated, $I_{OUT} = 10\text{ mA}$, Constant Voltage Mode, $T_A = 25^\circ\text{C}$. Refer to Figure 1-1 for test circuit.

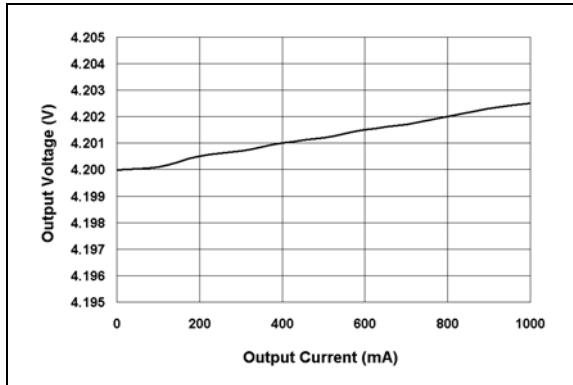

FIGURE 2-1: Output Voltage vs. Output Current (MCP73826-4.2).

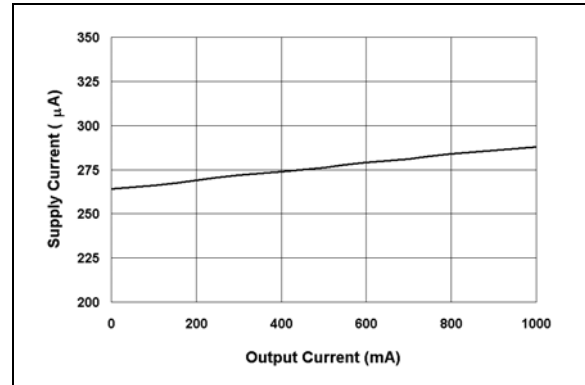

FIGURE 2-4: Supply Current vs. Output Current.

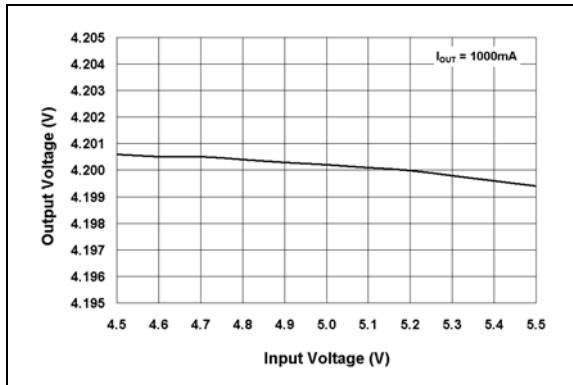

FIGURE 2-2: Output Voltage vs. Input Voltage (MCP73826-4.2).

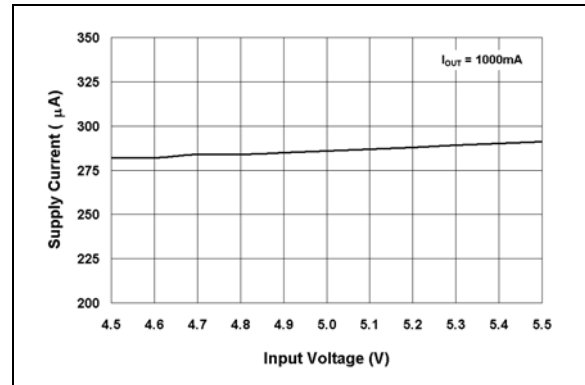

FIGURE 2-5: Supply Current vs. Input Voltage.

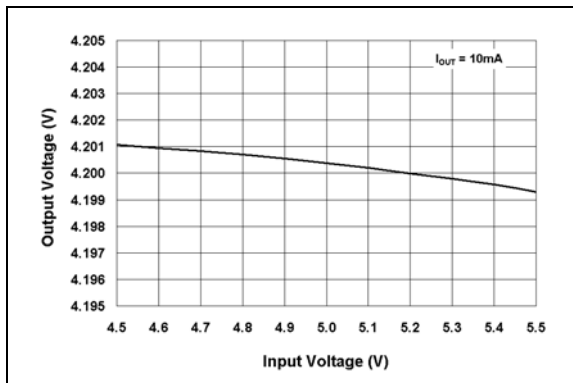

FIGURE 2-3: Output Voltage vs. Input Voltage (MCP73826-4.2).

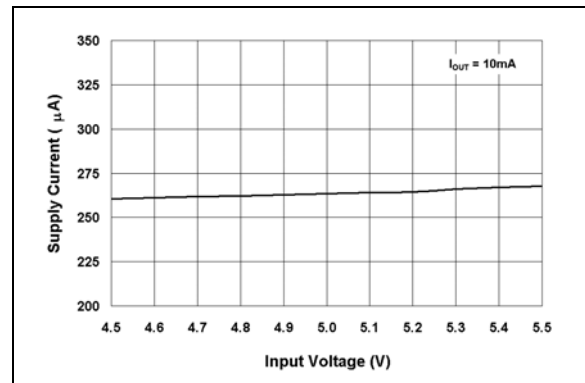

FIGURE 2-6: Supply Current vs. Input Voltage.

MCP73826

Note: Unless otherwise indicated, $I_{OUT} = 10\text{ mA}$, Constant Voltage Mode, $T_A = 25^\circ\text{C}$. Refer to Figure 1-1 for test circuit.

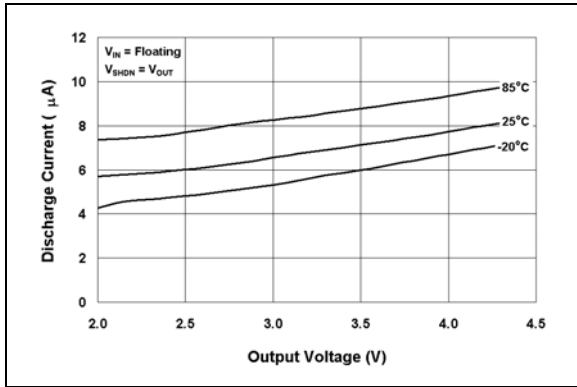

FIGURE 2-7: Output Reverse Leakage Current vs. Output Voltage.

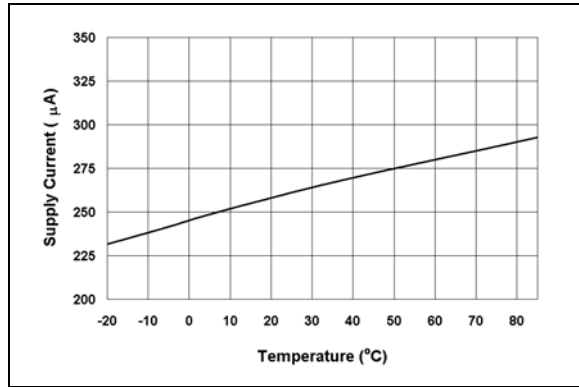

FIGURE 2-10: Supply Current vs. Temperature.

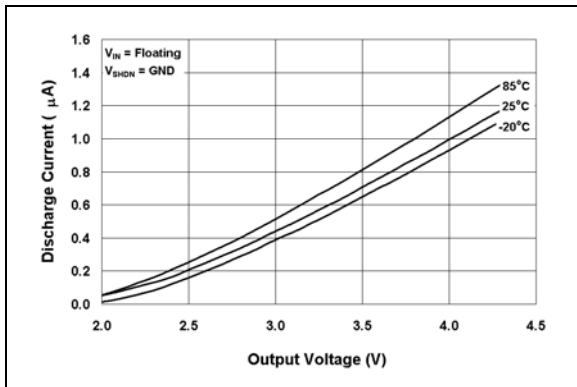

FIGURE 2-8: Output Reverse Leakage Current vs. Output Voltage.

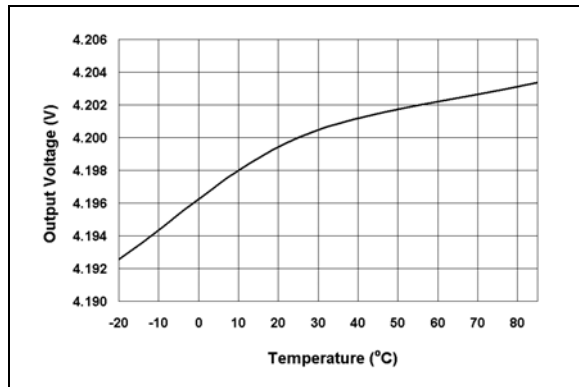

FIGURE 2-11: Output Voltage vs. Temperature (MCP73826-4.2).

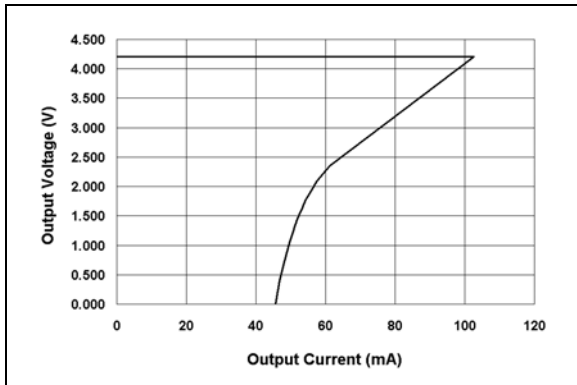

FIGURE 2-9: Current Limit Foldback.

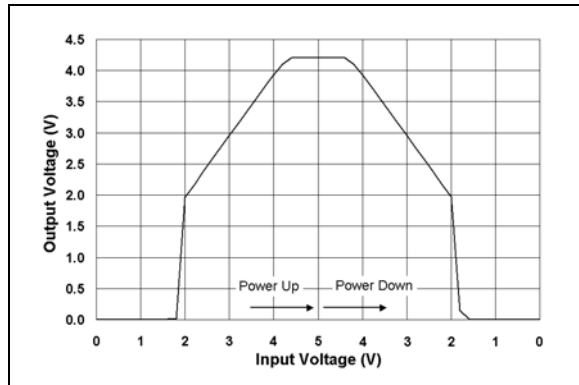

FIGURE 2-12: Power-Up / Power-Down.

Note: Unless otherwise indicated, $I_{OUT} = 10\text{ mA}$, Constant Voltage Mode, $T_A = 25^\circ\text{C}$. Refer to Figure 1-1 for test circuit.

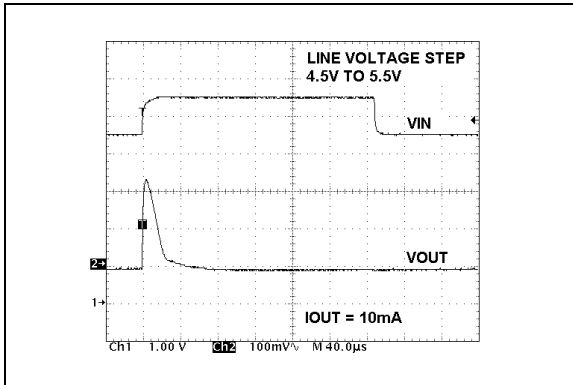

FIGURE 2-13: Line Transient Response.

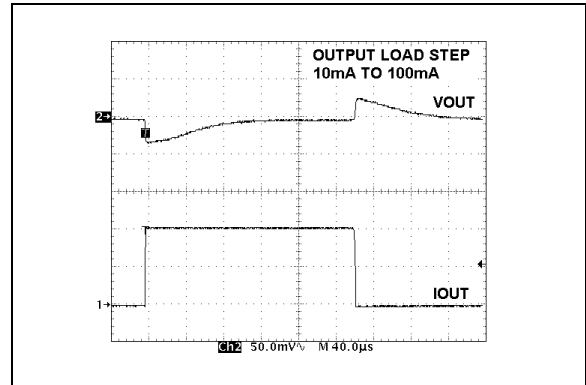

FIGURE 2-15: Load Transient Response.

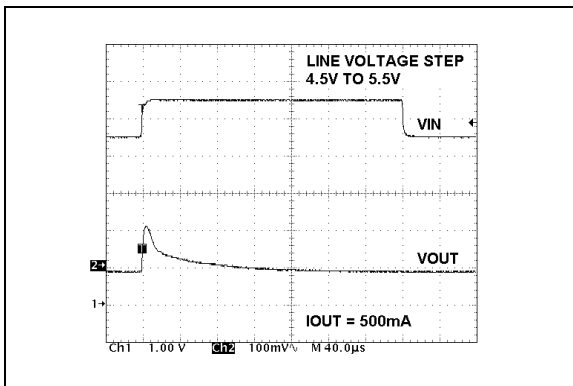

FIGURE 2-14: Line Transient Response.

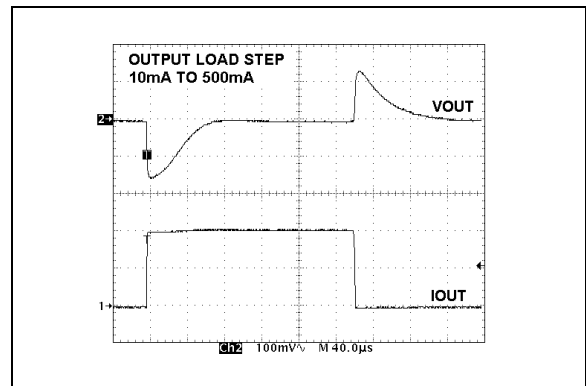

FIGURE 2-16: Load Transient Response.

MCP73826

3.0 PIN DESCRIPTION

The descriptions of the pins are listed in Table 3-1.

Pin	Name	Description
1	SHDN	Logic Shutdown
2	GND	Battery Management 0V Reference
3	V _{BAT}	Cell Voltage Monitor Input
4	V _{DRV}	Drive Output
5	V _{IN}	Battery Management Input Supply
6	V _{SNS}	Charge Current Sense Input

TABLE 3-1: Pin Function Table.

3.1 Logic Shutdown (SHDN)

Input to force charge termination, initiate charge, or initiate recharge.

3.2 Battery Management 0V Reference (GND)

Connect to negative terminal of battery.

3.3 Cell Voltage Monitor Input (VBAT)

Voltage sense input. Connect to positive terminal of battery. Bypass to GND with a minimum of 10 μ F to ensure loop stability when the battery is disconnected. A precision internal resistor divider regulates the final voltage on this pin to V_{REG}.

3.4 Drive Output (VDRV)

Direct output drive of an external P-channel MOSFET pass transistor for current and voltage regulation.

3.5 Battery Management Input Supply (VIN)

A supply voltage of 4.5V to 5.5V is recommended. Bypass to GND with a minimum of 10 μ F.

3.6 Charge Current Sense Input (VSNS)

Charge current is sensed via the voltage developed across an external precision sense resistor. The sense resistor must be placed between the supply voltage (V_{IN}) and the source of the external pass transistor. A 50 m Ω sense resistor produces a fast charge current of 1 A, typically.

4.0 DEVICE OVERVIEW

The MCP73826 is a linear charge management controller. Refer to the functional block diagram on page 2 and the typical application circuit, Figure 6-1.

4.1 Charge Qualification and Preconditioning

Upon insertion of a battery or application of an external supply, the MCP73826 verifies the state of the $\overline{\text{SHDN}}$ pin. The $\overline{\text{SHDN}}$ pin must be above the logic high level.

If the $\overline{\text{SHDN}}$ pin is above the logic high level, the MCP73826 initiates a charge cycle. If the cell is below the preconditioning threshold, 2.4V typically, the MCP73826 preconditions the cell with a scaled back current. The preconditioning current is set to approximately 43% of the fast charge peak current. The preconditioning safely replenishes deeply depleted cells and minimizes heat dissipation in the external pass transistor during the initial charge cycle.

4.2 Controlled Current Regulation - Fast Charge

Preconditioning ends and fast charging begins when the cell voltage exceeds the preconditioning threshold. Fast charge utilizes a foldback current scheme based on the voltage at the V_{SNS} input developed by the drop across an external sense resistor, R_{SENSE} , and the output voltage, V_{BAT} . Fast charge continues until the cell voltage reaches the regulation voltage, V_{REG} .

4.3 Constant Voltage Regulation

When the cell voltage reaches the regulation voltage, V_{REG} , constant voltage regulation begins. The MCP73826 monitors the cell voltage at the V_{BAT} pin. This input is tied directly to the positive terminal of the battery. The MCP73826 is offered in two fixed-voltage versions for battery packs with either coke or graphite anodes: 4.1V (MCP73826-4.1) and 4.2V (MCP73826-4.2).

4.4 Charge Cycle Completion

The charge cycle can be terminated by a host microcontroller after an elapsed time from the start of the charge cycle. The charge is terminated by pulling the shutdown pin, $\overline{\text{SHDN}}$, to a logic Low level.

MCP73826

5.0 DETAILED DESCRIPTION

Refer to the typical application circuit, Figure 6-1.

5.1 Analog Circuitry

5.1.1 OUTPUT VOLTAGE INPUT (V_{BAT})

The MCP73826 monitors the cell voltage at the V_{BAT} pin. This input is tied directly to the positive terminal of the battery. The MCP73826 is offered in two fixed-voltage versions for single cells with either coke or graphite anodes: 4.1V (MCP73826-4.1) and 4.2V (MCP73826-4.2).

5.1.2 GATE DRIVE OUTPUT (V_{DRV})

The MCP73826 controls the gate drive to an external P-channel MOSFET, Q1. The P-channel MOSFET is controlled in the linear region, regulating current and voltage supplied to the cell. The drive output is automatically turned off when the input supply falls below the voltage sensed on the V_{BAT} input.

5.1.3 SUPPLY VOLTAGE (V_{IN})

The V_{IN} input is the input supply to the MCP73826. The MCP73826 automatically enters a power-down mode if the voltage on the V_{IN} input falls below the voltage on the V_{BAT} pin. This feature prevents draining the battery pack when the V_{IN} supply is not present.

5.1.4 CURRENT SENSE INPUT (V_{SNS})

Fast charge current regulation is maintained by the voltage drop developed across an external sense resistor, R_{SENSE} , applied to the V_{SNS} input pin. The following formula calculates the value for R_{SENSE} :

$$R_{SENSE} = \frac{V_{CS}}{I_{OUT}}$$

Where:

V_{CS} is the current limit threshold

I_{OUT} is the desired peak fast charge current in amps. The preconditioning current is scaled to approximately 43% of I_{OUT} .

5.2 Digital Circuitry

5.2.1 SHUTDOWN INPUT (\overline{SHDN})

The shutdown input pin, \overline{SHDN} , can be used to terminate a charge anytime during the charge cycle, initiate a charge cycle, or initiate a recharge cycle.

Applying a logic High input signal to the \overline{SHDN} pin, or tying it to the input source, enables the device. Applying a logic Low input signal disables the device and terminates a charge cycle. In shutdown mode, the device's supply current is reduced to 0.5 μ A, typically.

6.0 APPLICATIONS

The MCP73826 is designed to operate in conjunction with a host microcontroller or in stand-alone applications. The MCP73826 provides the preferred charge

algorithm for Lithium-Ion cells, controlled current followed by constant voltage. Figure 6-1 depicts a typical stand-alone application circuit and Figure 6-2 depicts the accompanying charge profile.

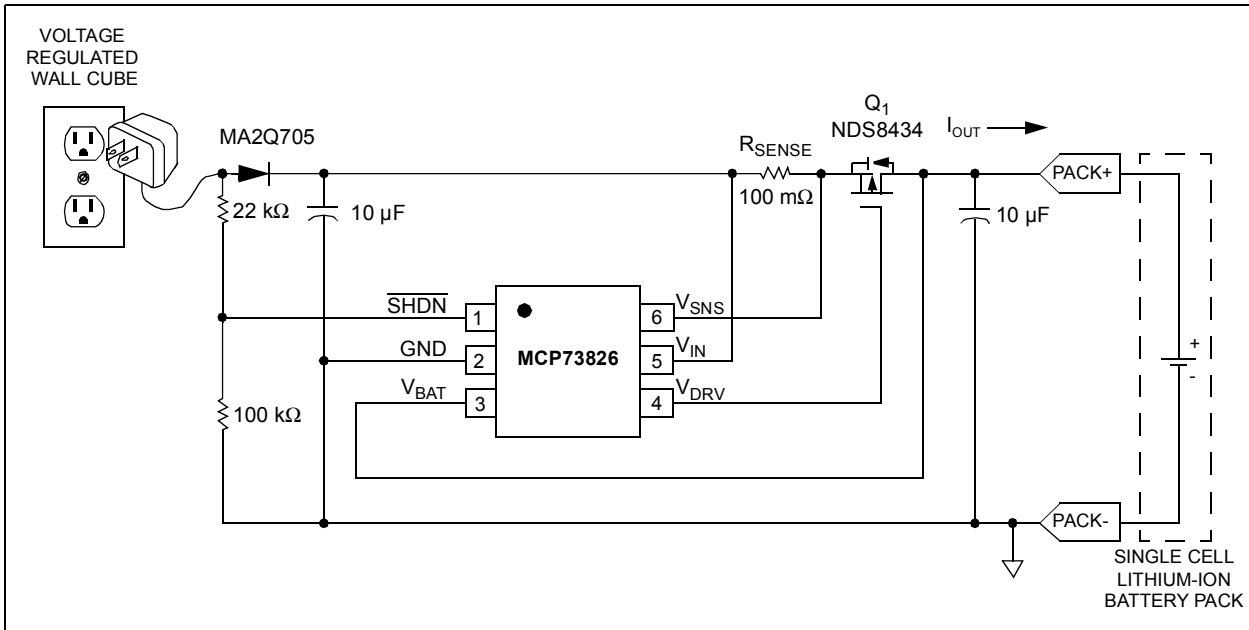

FIGURE 6-1: Typical Application Circuit.

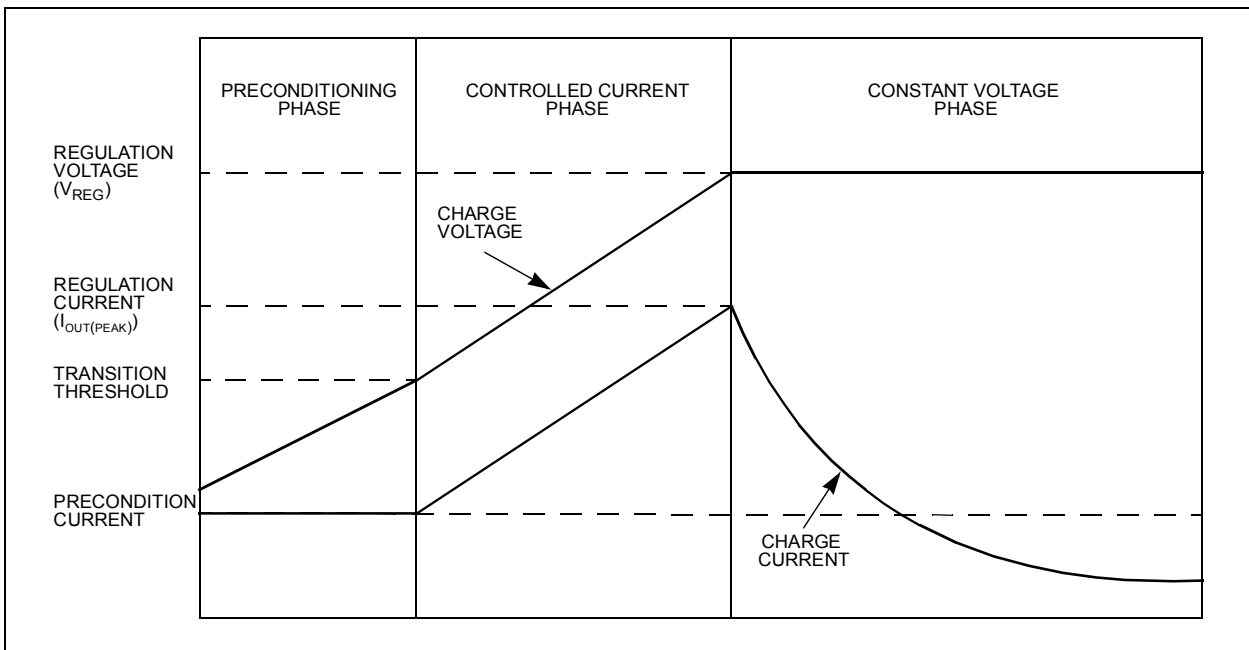

FIGURE 6-2: Typical Charge Profile.

MCP73826

6.1 Application Circuit Design

Due to the low efficiency of linear charging, the most important factors are thermal design and cost, which are a direct function of the input voltage, output current and thermal impedance between the external P-channel pass transistor, Q1, and the ambient cooling air. The worst-case situation is when the output is shorted. In this situation, the P-channel pass transistor has to dissipate the maximum power. A trade-off must be made between the charge current, cost and thermal requirements of the charger.

6.1.1 COMPONENT SELECTION

Selection of the external components in Figure 6-1 is crucial to the integrity and reliability of the charging system. The following discussion is intended as a guide for the component selection process.

6.1.1.1 SENSE RESISTOR

The preferred fast charge current for Lithium-Ion cells is at the 1C rate with an absolute maximum current at the 2C rate. For example, a 500 mAH battery pack has a preferred fast charge current of 500 mA. Charging at this rate provides the shortest charge cycle times without degradation to the battery pack performance or life.

The current sense resistor, R_{SENSE} , is calculated by:

$$R_{SENSE} = \frac{V_{CS}}{I_{OUT}}$$

Where:

V_{CS} is the current limit threshold voltage

I_{OUT} is the desired peak fast charge current

For the 500 mAH battery pack example, a standard value 100 m Ω , 1% resistor provides a typical peak fast charge current of 530 mA and a maximum peak fast charge current of 758 mA. Worst case power dissipation in the sense resistor is:

$$PowerDissipation = 100m\Omega \times 758mA^2 = 57.5mW$$

A Panasonic ERJ-L1WKF100U 100 m Ω , 1%, 1 W resistor is more than sufficient for this application.

A larger value sense resistor will decrease the peak fast charge current and power dissipation in both the sense resistor and external pass transistor, but will increase charge cycle times. Design trade-offs must be considered to minimize space while maintaining the desired performance.

6.1.1.2 EXTERNAL PASS TRANSISTOR

The external P-channel MOSFET is determined by the gate to source threshold voltage, input voltage, output voltage, and peak fast charge current. The selected P-channel MOSFET must satisfy the thermal and electrical design requirements.

Thermal Considerations

The worst case power dissipation in the external pass transistor occurs when the input voltage is at the maximum and the output is shorted. In this case, the power dissipation is:

$$PowerDissipation = V_{INMAX} \times I_{OUT} \times K$$

Where:

V_{INMAX} is the maximum input voltage

I_{OUT} is the maximum peak fast charge current

K is the foldback current scale factor

Power dissipation with a 5V, +/-10% input voltage source, 100 m Ω , 1% sense resistor, and a scale factor of 0.43 is:

$$PowerDissipation = 5.5V \times 758mA \times 0.43 = 1.8W$$

Utilizing a Fairchild NDS8434 or an International Rectifier IRF7404 mounted on a 1in² pad of 2 oz. copper, the junction temperature rise is 90°C, approximately. This would allow for a maximum operating ambient temperature of 60°C.

By increasing the size of the copper pad, a higher ambient temperature can be realized or a lower value sense resistor could be utilized.

Alternatively, different package options can be utilized for more or less power dissipation. Again, design trade-offs should be considered to minimize size while maintaining the desired performance.

Electrical Considerations

The gate to source threshold voltage and $R_{DS(ON)}$ of the external P-channel MOSFET must be considered in the design phase.

The worst case, V_{GS} provided by the controller occurs when the input voltage is at the minimum and the charge current is at the maximum. The worst case, V_{GS} is:

$$V_{GS} = V_{DRVMAX} - (V_{INMIN} - I_{OUT} \times R_{SENSE})$$

Where:

V_{DRVMAX} is the maximum sink voltage at the V_{DRV} output

V_{INMIN} is the minimum input voltage source

I_{OUT} is the maximum peak fast charge current

R_{SENSE} is the sense resistor

Worst case, V_{GS} with a 5V, +/-10% input voltage source, 100 mΩ, 1% sense resistor, and a maximum sink voltage of 1.6V is:

$$V_{GS} = 1.6V - (4.5V - 758mA \times 99m\Omega) = -2.8V$$

At this worst case, V_{GS} , the R_{DSON} of the MOSFET must be low enough as to not impede the performance of the charging system. The maximum allowable R_{DSON} at the worst case V_{GS} is:

$$R_{DSON} = \frac{V_{INMIN} - I_{OUT} \times R_{SENSE} - V_{BATMAX}}{I_{OUT}}$$

$$R_{DSON} = \frac{4.5V - 758mA \times 99m\Omega - 4.242V}{758mA} = 242m\Omega$$

The Fairchild NDS8434 and International Rectifier IRF7404 both satisfy these requirements.

6.1.1.3 EXTERNAL CAPACITORS

The MCP73826 is stable with or without a battery load. In order to maintain good AC stability in the constant voltage mode, a minimum capacitance of 10 μF is recommended to bypass the V_{BAT} pin to GND. This capacitance provides compensation when there is no battery load. In addition, the battery and interconnections appear inductive at high frequencies. These elements are in the control feedback loop during constant voltage mode. Therefore, the bypass capacitance may be necessary to compensate for the inductive nature of the battery pack.

Virtually any good quality output filter capacitor can be used, independent of the capacitor's minimum ESR (Effective Series Resistance) value. The actual value of the capacitor and its associated ESR depends on the forward trans conductance, g_m , and capacitance of the external pass transistor. A 10 μF tantalum or aluminum electrolytic capacitor at the output is usually sufficient to ensure stability for up to a 1 A output current.

6.1.1.4 REVERSE BLOCKING PROTECTION

The optional reverse blocking protection diode depicted in Figure 6-1 provides protection from a faulted or shorted input or from a reversed polarity input source. Without the protection diode, a faulted or shorted input would discharge the battery pack through the body diode of the external pass transistor.

If a reverse protection diode is incorporated in the design, it should be chosen to handle the peak fast charge current continuously at the maximum ambient temperature. In addition, the reverse leakage current of the diode should be kept as small as possible.

6.1.1.5 SHUTDOWN INTERFACE

In the stand-alone configuration, the shutdown pin is generally tied to the input voltage. The MCP73826 will automatically enter a low power mode when the input voltage is less than the output voltage reducing the battery drain current to 8 μA, typically.

By connecting the shutdown pin as depicted in Figure 6-1, the battery drain current may be further reduced. In this application, the battery drain current becomes a function of the reverse leakage current of the reverse protection diode.

6.2 PCB Layout Issues

For optimum voltage regulation, place the battery pack as close as possible to the device's V_{BAT} and GND pins. It is recommended to minimize voltage drops along the high current carrying PCB traces.

If the PCB layout is used as a heatsink, adding many vias around the external pass transistor can help conduct more heat to the back-plane of the PCB, thus reducing the maximum junction temperature.

MCP73826

7.0 PACKAGING INFORMATION

7.1 Package Marking Information

6-Pin SOT-23A (EIAJ SC-74) Device

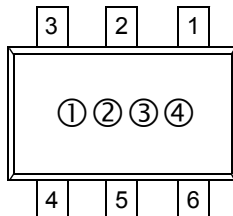

Part Number	Code
MCP73826-4.1VCH	CN
MCP73826-4.2VCH	CP

Legend:

- 1 Part Number code + temperature range and voltage (two letter code)
- 2 Part Number code + temperature range and voltage (two letter code)
- 3 Year and 2-month period code
- 4 Lot ID number

Note: In the event the full Microchip part number cannot be marked on one line, it will be carried over to the next line thus limiting the number of available characters for customer specific information.

7.2 Package Dimensions

Component Taping Orientation for 6-Pin SOT-23A (EIAJ SC-74) Devices

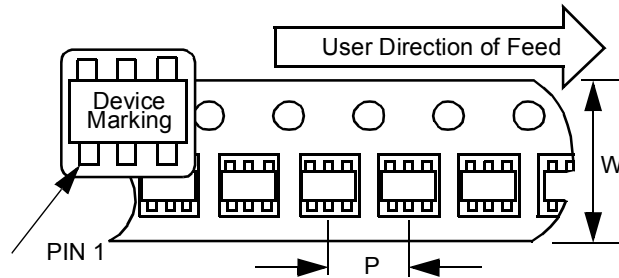

Standard Reel Component Orientation
for TR Suffix Device
(Mark Right Side Up)

Carrier Tape, Number of Components Per Reel and Reel Size:

Package	Carrier Width (W)	Pitch (P)	Part Per Full Reel	Reel Size
6-Pin SOT-23A	8 mm	4 mm	3000	7 in.

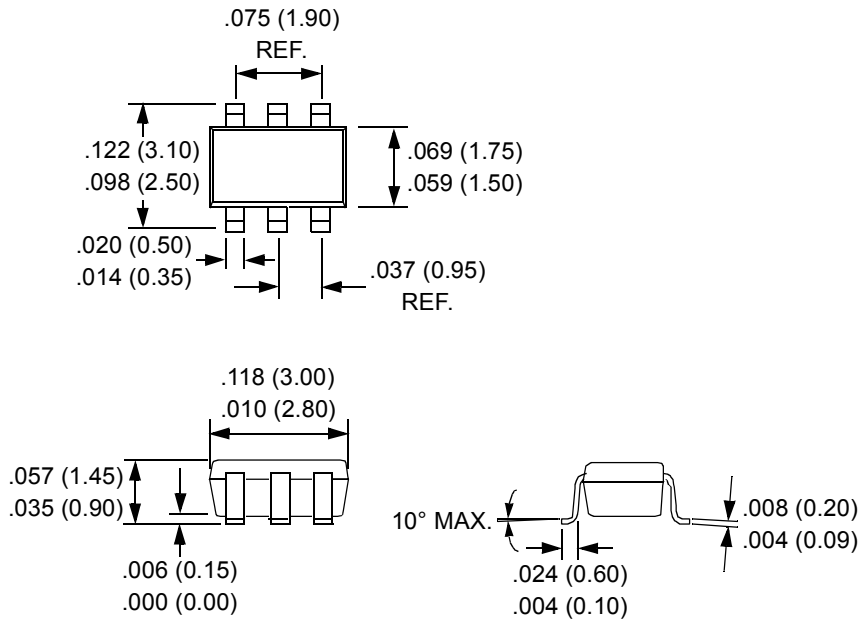

MCP73826

NOTES:

ON-LINE SUPPORT

Microchip provides on-line support on the Microchip World Wide Web (WWW) site.

The web site is used by Microchip as a means to make files and information easily available to customers. To view the site, the user must have access to the Internet and a web browser, such as Netscape or Microsoft Explorer. Files are also available for FTP download from our FTP site.

Connecting to the Microchip Internet Web Site

The Microchip web site is available by using your favorite Internet browser to attach to:

www.microchip.com

The file transfer site is available by using an FTP service to connect to:

<ftp://ftp.microchip.com>

The web site and file transfer site provide a variety of services. Users may download files for the latest Development Tools, Data Sheets, Application Notes, User's Guides, Articles and Sample Programs. A variety of Microchip specific business information is also available, including listings of Microchip sales offices, distributors and factory representatives. Other data available for consideration is:

- Latest Microchip Press Releases
- Technical Support Section with Frequently Asked Questions
- Design Tips
- Device Errata
- Job Postings
- Microchip Consultant Program Member Listing
- Links to other useful web sites related to Microchip Products
- Conferences for products, Development Systems, technical information and more
- Listing of seminars and events

Systems Information and Upgrade Hot Line

The Systems Information and Upgrade Line provides system users a listing of the latest versions of all of Microchip's development systems software products. Plus, this line provides information on how customers can receive any currently available upgrade kits. The Hot Line Numbers are:

1-800-755-2345 for U.S. and most of Canada, and

1-480-792-7302 for the rest of the world.

013001

MCP73826

READER RESPONSE

It is our intention to provide you with the best documentation possible to ensure successful use of your Microchip product. If you wish to provide your comments on organization, clarity, subject matter, and ways in which our documentation can better serve you, please FAX your comments to the Technical Publications Manager at (480) 792-4150.

Please list the following information, and use this outline to provide us with your comments about this Data Sheet.

To: Technical Publications Manager Total Pages Sent
RE: Reader Response
From: Name _____
Company _____
Address _____
City / State / ZIP / Country _____
Telephone: (_____) _____ - _____ FAX: (_____) _____ - _____

Application (optional):

Would you like a reply? ___Y ___N

Device: **MCP73826** Literature Number: **DS21705A**

Questions:

1. What are the best features of this document?

2. How does this document meet your hardware and software development needs?

3. Do you find the organization of this data sheet easy to follow? If not, why?

4. What additions to the data sheet do you think would enhance the structure and subject?

5. What deletions from the data sheet could be made without affecting the overall usefulness?

6. Is there any incorrect or misleading information (what and where)?

7. How would you improve this document?

8. How would you improve our software, systems, and silicon products?

PRODUCT IDENTIFICATION SYSTEM

To order or obtain information, e.g., on pricing or delivery, refer to the factory or the listed sales office.

<u>PART NO.</u>	<u>-X.X</u>	<u>X</u>	<u>XXX</u>
Device	Output Voltage	Temperature Range	Package
Device:	MCP73826: Linear Charge Management Controller		
Output Voltage:	= 4.1V = 4.2V		
Temperature Range:	V = -20°C to +85°C		
Package:	CHTR = SOT-23, 6-lead (Tape and Reel)		

Examples:

- MCP73826-4.1VCHTR: Linear Charge Management Controller, 4.1V, Tape and Reel.
- MCP73826-4.2VCHTR: Linear Charge Management Controller, 4.2V, Tape and Reel.

Sales and Support

Data Sheets

Products supported by a preliminary Data Sheet may have an errata sheet describing minor operational differences and recommended workarounds. To determine if an errata sheet exists for a particular device, please contact one of the following:

- Your local Microchip sales office
- The Microchip Corporate Literature Center U.S. FAX: (480) 792-7277
- The Microchip Worldwide Site (www.microchip.com)

Please specify which device, revision of silicon and Data Sheet (include Literature #) you are using.

New Customer Notification System

Register on our web site (www.microchip.com/cn) to receive the most current information on our products.

MCP73826

NOTES:

NOTES:

MCP73826

NOTES:

Information contained in this publication regarding device applications and the like is intended through suggestion only and may be superseded by updates. It is your responsibility to ensure that your application meets with your specifications. No representation or warranty is given and no liability is assumed by Microchip Technology Incorporated with respect to the accuracy or use of such information, or infringement of patents or other intellectual property rights arising from such use or otherwise. Use of Microchip's products as critical components in life support systems is not authorized except with express written approval by Microchip. No licenses are conveyed, implicitly or otherwise, under any intellectual property rights.

Trademarks

The Microchip name and logo, the Microchip logo, FilterLab, KEELOQ, MPLAB, PIC, PICmicro, PICMASTER, PICSTART, PRO MATE, SEEVAL and The Embedded Control Solutions Company are registered trademarks of Microchip Technology Incorporated in the U.S.A. and other countries.

dsPIC, ECONOMONITOR, FanSense, FlexROM, fuzzyLAB, In-Circuit Serial Programming, ICSP, ICEPIC, microID, microPort, Migratable Memory, MPASM, MPLIB, MPLINK, MPSIM, MXDEV, PICC, PICDEM, PICDEM.net, rPIC, Select Mode and Total Endurance are trademarks of Microchip Technology Incorporated in the U.S.A.

Serialized Quick Term Programming (SQTP) is a service mark of Microchip Technology Incorporated in the U.S.A.

All other trademarks mentioned herein are property of their respective companies.

© 2002, Microchip Technology Incorporated, Printed in the U.S.A., All Rights Reserved.

 Printed on recycled paper.

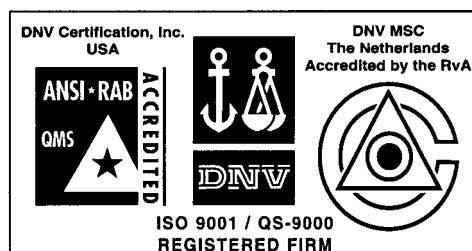

Microchip received QS-9000 quality system certification for its worldwide headquarters, design and wafer fabrication facilities in Chandler and Tempe, Arizona in July 1999. The Company's quality system processes and procedures are QS-9000 compliant for its PICmicro® 8-bit MCUs, KEELOQ® code hopping devices, Serial EEPROMs and microperipheral products. In addition, Microchip's quality system for the design and manufacture of development systems is ISO 9001 certified.



MICROCHIP

WORLDWIDE SALES AND SERVICE

AMERICAS

Corporate Office

2355 West Chandler Blvd.
Chandler, AZ 85224-6199
Tel: 480-792-7200 Fax: 480-792-7277
Technical Support: 480-792-7627
Web Address: <http://www.microchip.com>

Rocky Mountain

2355 West Chandler Blvd.
Chandler, AZ 85224-6199
Tel: 480-692-7966 Fax: 480-792-7456

Atlanta

500 Sugar Mill Road, Suite 200B
Atlanta, GA 30350
Tel: 770-640-0034 Fax: 770-640-0307

Boston

2 Lan Drive, Suite 120
Westford, MA 01886
Tel: 978-692-3848 Fax: 978-692-3821

Chicago

333 Pierce Road, Suite 180
Itasca, IL 60143
Tel: 630-285-0071 Fax: 630-285-0075

Dallas

4570 Westgrove Drive, Suite 160
Addison, TX 75001
Tel: 972-818-7423 Fax: 972-818-2924

Detroit

Tri-Atria Office Building
32255 Northwestern Highway, Suite 190
Farmington Hills, MI 48334
Tel: 248-538-2250 Fax: 248-538-2260

Kokomo

2767 S. Albright Road
Kokomo, Indiana 46902
Tel: 765-864-8360 Fax: 765-864-8387

Los Angeles

18201 Von Karman, Suite 1090
Irvine, CA 92612
Tel: 949-263-1888 Fax: 949-263-1338

New York

150 Motor Parkway, Suite 202
Hauppauge, NY 11788
Tel: 631-273-5305 Fax: 631-273-5335

San Jose

Microchip Technology Inc.
2107 North First Street, Suite 590
San Jose, CA 95131
Tel: 408-436-7950 Fax: 408-436-7955

Toronto

6285 Northam Drive, Suite 108
Mississauga, Ontario L4V 1X5, Canada
Tel: 905-673-0699 Fax: 905-673-6509

ASIA/PACIFIC

Australia

Microchip Technology Australia Pty Ltd
Suite 22, 41 Rawson Street
Epping 2121, NSW
Australia
Tel: 61-2-9868-6733 Fax: 61-2-9868-6755

China - Beijing

Microchip Technology Consulting (Shanghai)
Co., Ltd., Beijing Liaison Office
Unit 915
Bei Hai Wan Tai Bldg.
No. 6 Chaoyangmen Beidajie
Beijing, 100027, No. China
Tel: 86-10-85282100 Fax: 86-10-85282104

China - Chengdu

Microchip Technology Consulting (Shanghai)
Co., Ltd., Chengdu Liaison Office
Rm. 2401, 24th Floor,
Ming Xing Financial Tower
No. 88 TIDU Street
Chengdu 610016, China
Tel: 86-28-6766200 Fax: 86-28-6766599

China - Fuzhou

Microchip Technology Consulting (Shanghai)
Co., Ltd., Fuzhou Liaison Office
Unit 28F, World Trade Plaza
No. 71 Wusi Road
Fuzhou 350001, China
Tel: 86-591-7503506 Fax: 86-591-7503521

China - Shanghai

Microchip Technology Consulting (Shanghai)
Co., Ltd.
Room 701, Bldg. B
Far East International Plaza
No. 317 Xian Xia Road
Shanghai, 200051
Tel: 86-21-6275-5700 Fax: 86-21-6275-5060

China - Shenzhen

Microchip Technology Consulting (Shanghai)
Co., Ltd., Shenzhen Liaison Office
Rm. 1315, 13/F, Shenzhen Kerry Centre,
Renminnan Lu
Shenzhen 518001, China
Tel: 86-755-2350361 Fax: 86-755-2366086

Hong Kong

Microchip Technology Hongkong Ltd.
Unit 901-6, Tower 2, Metroplaza
223 Hing Fong Road
Kwai Fong, N.T., Hong Kong
Tel: 852-2401-1200 Fax: 852-2401-3431

India

Microchip Technology Inc.
India Liaison Office
Divyasree Chambers
1 Floor, Wing A (A3/A4)
No. 11, O'Shaughnessey Road
Bangalore, 560 025, India
Tel: 91-80-2290061 Fax: 91-80-2290062

Japan

Microchip Technology Japan K.K.
Benex S-1 6F
3-18-20, Shinyokohama
Kohoku-Ku, Yokohama-shi
Kanagawa, 222-0033, Japan
Tel: 81-45-471-6166 Fax: 81-45-471-6122

Korea

Microchip Technology Korea
168-1, Youngbo Bldg. 3 Floor
Samsung-Dong, Kangnam-Ku
Seoul, Korea 135-882
Tel: 82-2-554-7200 Fax: 82-2-558-5934

Singapore

Microchip Technology Singapore Pte Ltd.
200 Middle Road
#07-02 Prime Centre
Singapore, 188980
Tel: 65-334-8870 Fax: 65-334-8850

Taiwan

Microchip Technology Taiwan
11F-3, No. 207
Tung Hua North Road
Taipei, 105, Taiwan
Tel: 886-2-2717-7175 Fax: 886-2-2545-0139

EUROPE

Denmark

Microchip Technology Nordic ApS
Regus Business Centre
Lautrup høj 1-3
Ballerup DK-2750 Denmark
Tel: 45 4420 9895 Fax: 45 4420 9910

France

Microchip Technology SARL
Parc d'Activite du Moulin de Massy
43 Rue du Saule Trapu
Batiment A - 1er Etage
91300 Massy, France
Tel: 33-1-69-53-63-20 Fax: 33-1-69-30-90-79

Germany

Microchip Technology GmbH
Gustav-Heinemann Ring 125
D-81739 Munich, Germany
Tel: 49-89-627-144 0 Fax: 49-89-627-144-44

Italy

Microchip Technology SRL
Centro Direzionale Colleoni
Palazzo Taurus 1 V. Le Colleoni 1
20041 Agrate Brianza
Milan, Italy
Tel: 39-039-65791-1 Fax: 39-039-6899883

United Kingdom

Arizona Microchip Technology Ltd.
505 Eskdale Road
Winnersh Triangle
Wokingham
Berkshire, England RG41 5TU
Tel: 44 118 921 5869 Fax: 44-118 921-5820

01/18/02

