

# NUF6401MN

## 6 Line EMI Filter with ESD Protection

This device is a 6 line EMI filter array for wireless applications. Greater than -30 dB attenuation is obtained at frequencies from 800 MHz to 3.0 GHz. It also offers ESD protection clamping transients from static discharges. ESD protection is provided across all capacitors.

### Features

- EMI Filtering and ESD Protection
- Integration of 30 Discrete Components
- DFN Package, 1.35 x 3.0 mm
- Moisture Sensitivity Level 1
- ESD Ratings: IEC61000-4-2 (Level 4)  
Machine Model = C  
Human Body Model = 3B
- This is a Pb-Free Device\*

### Benefits

- Reduces EMI/RFI Emissions on a Data Line
- Integrated Solution Offers Cost and Space Savings in a DFN Package
- Excellent S21 Characteristics with very Low Parasitic Inductances
- Integrated Solution Improves System Reliability
- Compatible Footprint to BGA or Flip-Chip Package

### Applications

- EMI Filtering and ESD Protection for Data Lines
- Wireless Phones
- PDAs and Handheld Products
- Digital Camera
- LCD Displays

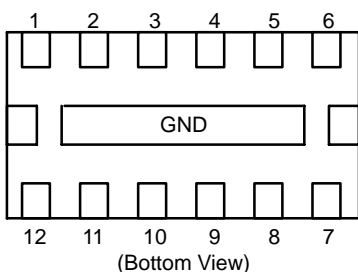

ON Semiconductor®

<http://onsemi.com>

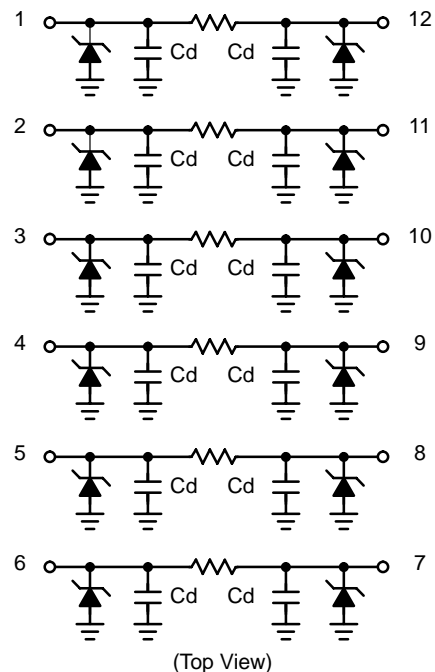

### MARKING DIAGRAM

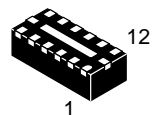

DFN12  
CASE 506AD

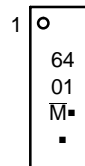

6401= Specific Device Code

M = Month

▪ = Pb-Free Package

(Note: Microdot may be in either location)

### ORDERING INFORMATION

Device	Package	Shipping†
NUF6401MNT1G	DFN12 (Pb-Free)	3000 / Tape & Reel

†For information on tape and reel specifications, including part orientation and tape sizes, please refer to our Tape and Reel Packaging Specifications Brochure, BRD8011/D.

\*For additional information on our Pb-Free strategy and soldering details, please download the ON Semiconductor Soldering and Mounting Techniques Reference Manual, SOLDERRM/D.

# NUF6401MN

## MAXIMUM RATINGS (T<sub>J</sub> = 25°C unless otherwise noted)

Parameter	Symbol	Value	Unit
ESD Discharge IEC61000-4-2 Contact Discharge	V <sub>PP</sub>	8.0	kV
DC Power per Resistor	P <sub>R</sub>	100	mW
DC Power per Package	P <sub>T</sub>	600	mW
Operating Temperature Range	T <sub>OP</sub>	-40 to 85	°C
Storage Temperature Range	T <sub>STG</sub>	-55 to 150	°C
Maximum Lead Temperature for Soldering Purposes (1.8 in from case for 10 seconds)	T <sub>L</sub>	260	°C

Maximum ratings are those values beyond which device damage can occur. Maximum ratings applied to the device are individual stress limit values (not normal operating conditions) and are not valid simultaneously. If these limits are exceeded, device functional operation is not implied, damage may occur and reliability may be affected.

## ELECTRICAL CHARACTERISTICS (T<sub>J</sub> = 25°C unless otherwise noted)

Parameter	Symbol	Test Conditions	Min	Typ	Max	Unit
Maximum Reverse Working Voltage	V <sub>RWM</sub>				5.0	V
Breakdown Voltage	V <sub>BR</sub>	I <sub>R</sub> = 1.0 mA	6.0	7.0		V
Leakage Current	I <sub>R</sub>	V <sub>RWM</sub> = 3.0 V		0.1	1.0	μA
Resistance	R <sub>A</sub>	I <sub>R</sub> = 20 mA	85	100	115	Ω
Capacitance (Notes 1 and 2)	C <sub>d</sub>	V <sub>R</sub> = 2.5 V, f = 1.0 MHz		17	20	pF
Cut-Off Frequency (Note 3)	f <sub>3dB</sub>	Above this frequency, appreciable attenuation occurs		105		MHz

1. Measured at 25°C, V<sub>R</sub> = 2.5 V, f = 1.0 MHz.
2. Total line capacitance is 2 times the Diode Capacitance (C<sub>d</sub>).
3. 50 Ω source and 50 Ω load termination.

# NUF6401MN

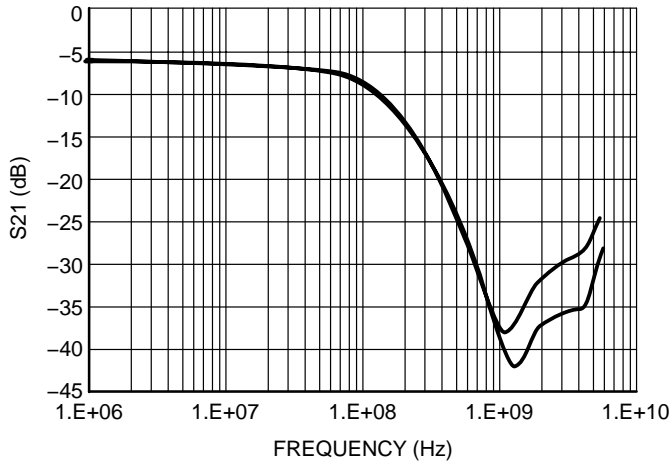

**Figure 1. Insertion Loss Characteristic**

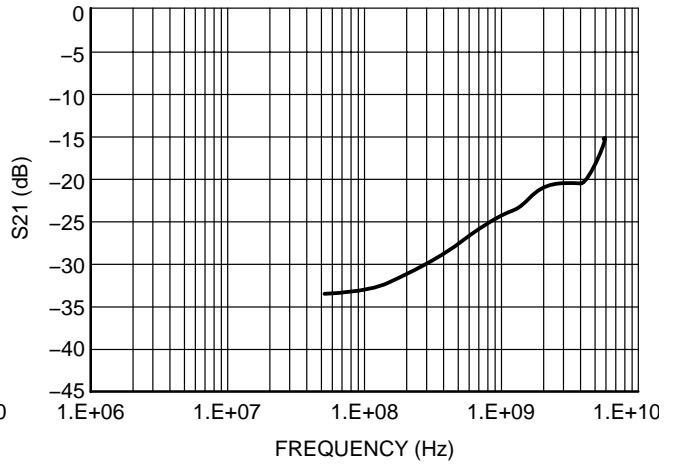

**Figure 2. Analog Crosstalk Curve**

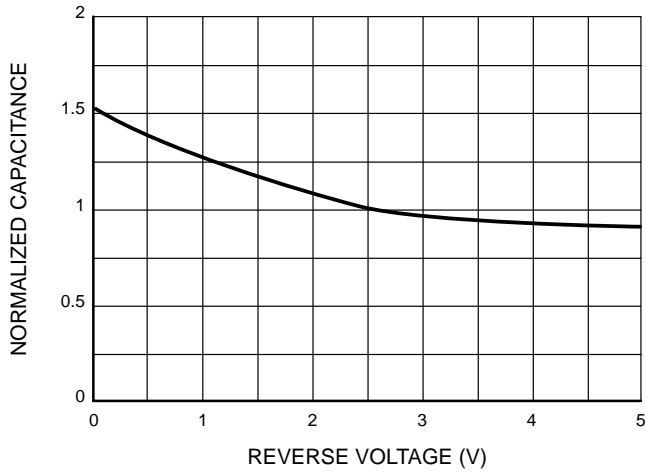

**Figure 3. Typical Capacitance vs. Reverse Biased Voltage  
(Normalized Capacitance, Cd @ 2.5 V)**

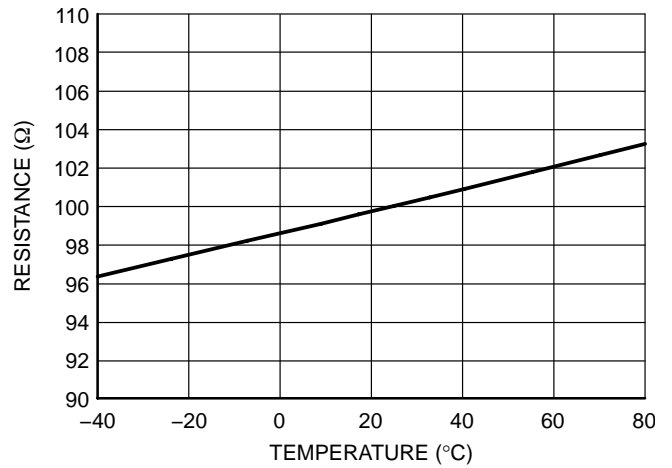
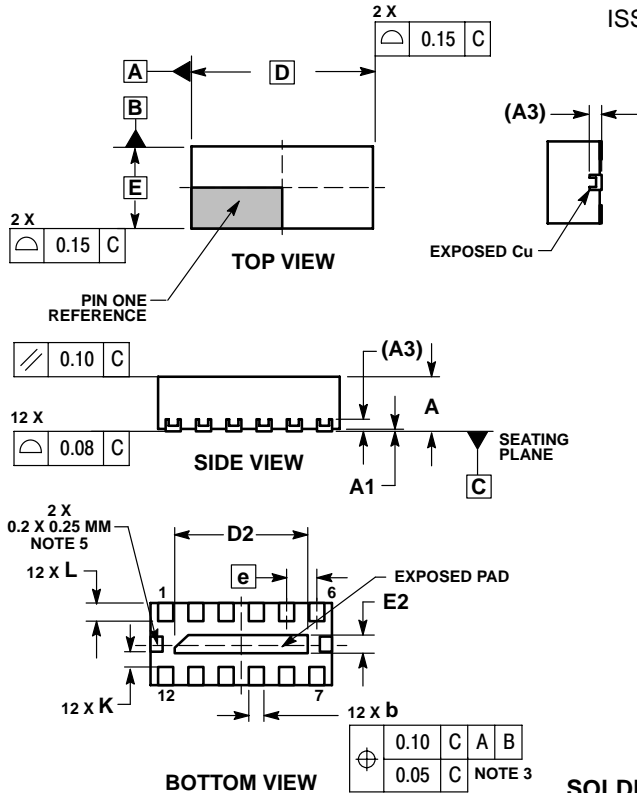

**Figure 4. Typical Resistance over Temperature**

# NUF6401MN

## PACKAGE DIMENSIONS

DFN12 3.0\*1.35\*0.85  
CASE 506AD-01  
ISSUE F



**NOTES:**

1. DIMENSIONING AND TOLERANCING PER ASME Y14.5M, 1994.
2. CONTROLLING DIMENSION: MILLIMETER.
3. DIMENSION b APPLIES TO PLATED TERMINAL AND IS MEASURED BETWEEN 0.25 AND 0.30 MM FROM TERMINAL.
4. COPLANARITY APPLIES TO THE EXPOSED PAD AS WELL AS THE TERMINALS.
5. EXPOSED PADS CONNECTED TO DIE FLAG. USED AS TEST CONTACTS.

MILLIMETERS		
DIM	MIN	MAX
A	0.80	1.00
A1	0.00	0.05
A3	0.20 REF	
b	0.18	0.30
D	3.00 BSC	
D2	2.10	2.30
E	1.35 BSC	
E2	0.20	0.40
e	0.50 BSC	
K	0.20	---
L	0.20	0.40

**SOLDERING FOOTPRINT\***

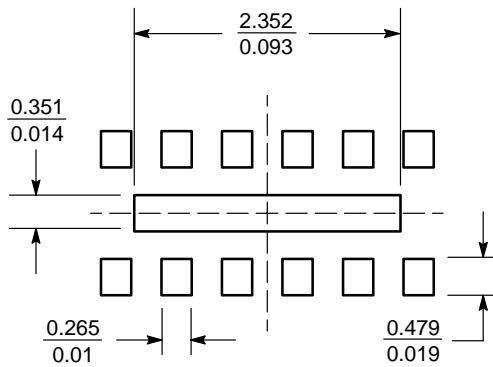

SCALE 16:1 (mm/inches)

\*For additional information on our Pb-Free strategy and soldering details, please download the ON Semiconductor Soldering and Mounting Techniques Reference Manual, SOLDERRM/D.

ON Semiconductor and are registered trademarks of Semiconductor Components Industries, LLC (SCILLC). SCILLC reserves the right to make changes without further notice to any products herein. SCILLC makes no warranty, representation or guarantee regarding the suitability of its products for any particular purpose, nor does SCILLC assume any liability arising out of the application or use of any product or circuit, and specifically disclaims any and all liability, including without limitation special, consequential or incidental damages. "Typical" parameters which may be provided in SCILLC data sheets and/or specifications can and do vary in different applications and actual performance may vary over time. All operating parameters, including "Typicals" must be validated for each customer application by customer's technical experts. SCILLC does not convey any license under its patent rights nor the rights of others. SCILLC products are not designed, intended, or authorized for use as components in systems intended for surgical implant into the body, or other applications intended to support or sustain life, or for any other application in which the failure of the SCILLC product could create a situation where personal injury or death may occur. Should Buyer purchase or use SCILLC products for any such unintended or unauthorized application, Buyer shall indemnify and hold SCILLC and its officers, employees, subsidiaries, affiliates, and distributors harmless against all claims, costs, damages, and expenses, and reasonable attorney fees arising out of, directly or indirectly, any claim of personal injury or death associated with such unintended or unauthorized use, even if such claim alleges that SCILLC was negligent regarding the design or manufacture of the part. SCILLC is an Equal Opportunity/Affirmative Action Employer. This literature is subject to all applicable copyright laws and is not for resale in any manner.

**PUBLICATION ORDERING INFORMATION**

**LITERATURE FULFILLMENT:**  
Literature Distribution Center for ON Semiconductor  
P.O. Box 61312, Phoenix, Arizona 85082-1312 USA  
**Phone:** 480-829-7710 or 800-344-3860 Toll Free USA/Canada  
**Fax:** 480-829-7709 or 800-344-3867 Toll Free USA/Canada  
**Email:** orderlit@onsemi.com

**N. American Technical Support:** 800-282-9855 Toll Free USA/Canada

**Japan:** ON Semiconductor, Japan Customer Focus Center  
2-9-1 Kamimeguro, Meguro-ku, Tokyo, Japan 153-0051  
**Phone:** 81-3-5773-3850

**ON Semiconductor Website:** <http://onsemi.com>

**Order Literature:** <http://www.onsemi.com/litorder>

For additional information, please contact your local Sales Representative.