

NSS40501UW3T2G

40 V, 7.0 A, Low $V_{CE(sat)}$ NPN Transistor

ON Semiconductor's e²PowerEdge family of low $V_{CE(sat)}$ transistors are miniature surface mount devices featuring ultra low saturation voltage ($V_{CE(sat)}$) and high current gain capability. These are designed for use in low voltage, high speed switching applications where affordable efficient energy control is important.

Typical applications are DC-DC converters and power management in portable and battery powered products such as cellular and cordless phones, PDAs, computers, printers, digital cameras and MP3 players. Other applications are low voltage motor controls in mass storage products such as disc drives and tape drives. In the automotive industry they can be used in air bag deployment and in the instrument cluster. The high current gain allows e²PowerEdge devices to be driven directly from PMU's control outputs, and the Linear Gain (Beta) makes them ideal components in analog amplifiers.

- This is a Pb-Free Device

MAXIMUM RATINGS ($T_A = 25^\circ\text{C}$)

| Rating | Symbol | Max | Unit |
|--------------------------------|-----------|----------------------------|------|
| Collector-Emitter Voltage | V_{CEO} | 40 | Vdc |
| Collector-Base Voltage | V_{CBO} | 40 | Vdc |
| Emitter-Base Voltage | V_{EBO} | 6.0 | Vdc |
| Collector Current - Continuous | I_C | 5.0 | Adc |
| Collector Current - Peak | I_{CM} | 7.0 | A |
| Electrostatic Discharge | ESD | HBM Class 3B MM Class C | |

THERMAL CHARACTERISTICS

| Characteristic | Symbol | Max | Unit |
|---|--------------------------|----------------|----------------------------|
| Total Device Dissipation, $T_A = 25^\circ\text{C}$ Derate above 25°C | P_D (Note 1) | 875 7.0 | mW mW/ $^\circ\text{C}$ |
| Thermal Resistance, Junction-to-Ambient | $R_{\theta JA}$ (Note 1) | 143 | $^\circ\text{C}/\text{W}$ |
| Total Device Dissipation, $T_A = 25^\circ\text{C}$ Derate above 25°C | P_D (Note 2) | 1.5 11.8 | W mW/ $^\circ\text{C}$ |
| Thermal Resistance, Junction-to-Ambient | $R_{\theta JA}$ (Note 2) | 85 | $^\circ\text{C}/\text{W}$ |
| Thermal Resistance, Junction-to-Lead #3 | $R_{\theta JL}$ (Note 2) | 23 | $^\circ\text{C}/\text{W}$ |
| Junction and Storage Temperature Range | T_J, T_{stg} | -55 to +150 | $^\circ\text{C}$ |

Stresses exceeding Maximum Ratings may damage the device. Maximum Ratings are stress ratings only. Functional operation above the Recommended Operating Conditions is not implied. Extended exposure to stresses above the Recommended Operating Conditions may affect device reliability.

1. FR-4 @ 100 mm², 1 oz copper traces.
2. FR-4 @ 500 mm², 1 oz copper traces.



ON Semiconductor®

<http://onsemi.com>

40 VOLTS, 7.0 AMPS NPN LOW $V_{CE(sat)}$ TRANSISTOR EQUIVALENT $R_{DS(on)}$ 38 m Ω

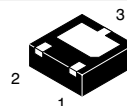
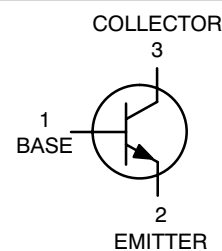

WDFN3
CASE 506AU

MARKING DIAGRAM

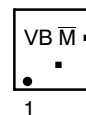

VB = Specific Device Code
M = Date Code
■ = Pb-Free Package

(Note: Microdot may be in either location)

ORDERING INFORMATION

| Device | Package | Shipping† |
|----------------|--------------------|----------------------|
| NSS40501UW3T2G | WDFN3 (Pb-Free) | 3000/ Tape & Reel |

†For information on tape and reel specifications, including part orientation and tape sizes, please refer to our Tape and Reel Packaging Specifications Brochure, BRD8011/D.

NSS40501UW3T2G

ELECTRICAL CHARACTERISTICS (T_A = 25°C unless otherwise noted)

| Characteristic | Symbol | Min | Typical | Max | Unit |
|---|----------------------|-----|---------|-----|------|
| OFF CHARACTERISTICS | | | | | |
| Collector-Emitter Breakdown Voltage (I _C = 10 mAdc, I _B = 0) | V _{(BR)CEO} | 40 | - | - | Vdc |
| Collector-Base Breakdown Voltage (I _C = 0.1 mAdc, I _E = 0) | V _{(BR)CBO} | 40 | - | - | Vdc |
| Emitter-Base Breakdown Voltage (I _E = 0.1 mAdc, I _C = 0) | V _{(BR)EBO} | 6.0 | - | - | Vdc |
| Collector Cutoff Current (V _{CB} = 40 Vdc, I _E = 0) | I _{CBO} | - | - | 0.1 | μAdc |
| Emitter Cutoff Current (V _{EB} = 6.0 Vdc) | I _{EBO} | - | - | 0.1 | μAdc |

ON CHARACTERISTICS

| | | | | | |
|---|----------------------|---------------------------------|--|--|-----|
| DC Current Gain (Note 3) (I _C = 10 mA, V _{CE} = 2.0 V) (I _C = 500 mA, V _{CE} = 2.0 V) (I _C = 1.0 A, V _{CE} = 2.0 V) (I _C = 2.0 A, V _{CE} = 2.0 V) (I _C = 3.0 A, V _{CE} = 2.0 V) | h _{FE} | 200 200 200 200 180 | - - 320 305 295 | - - - - - | |
| Collector-Emitter Saturation Voltage (Note 3) (I _C = 0.1 A, I _B = 0.010 A) (I _C = 1.0 A, I _B = 0.100 A) (I _C = 1.0 A, I _B = 0.010 A) (I _C = 2.0 A, I _B = 0.020 A) (I _C = 3.0 A, I _B = 0.030 A) (I _C = 4.0 A, I _B = 0.400 A) | V _{CE(sat)} | - - - - - - | 0.006 0.038 0.060 0.097 0.130 0.110 | 0.010 0.045 0.080 0.120 0.160 0.150 | V |
| Base-Emitter Saturation Voltage (Note 3) (I _C = 1.0 A, I _B = 0.01 A) | V _{BE(sat)} | - | 0.760 | 0.900 | V |
| Base-Emitter Turn-on Voltage (Note 3) (I _C = 2.0 A, V _{CE} = 2.0 V) | V _{BE(on)} | - | 0.730 | 0.900 | V |
| Cutoff Frequency (I _C = 100 mA, V _{CE} = 5.0 V, f = 100 MHz) | f _T | 150 | - | - | MHz |
| Input Capacitance (V _{EB} = 0.5 V, f = 1.0 MHz) | C _{ibo} | - | - | 650 | pF |
| Output Capacitance (V _{CB} = 3.0 V, f = 1.0 MHz) | C _{obo} | - | - | 70 | pF |

SWITCHING CHARACTERISTICS

| | | | | | |
|--|----------------|---|---|------|----|
| Delay (V _{CC} = 30 V, I _C = 750 mA, I _{B1} = 15 mA) | t _d | - | - | 90 | ns |
| Rise (V _{CC} = 30 V, I _C = 750 mA, I _{B1} = 15 mA) | t _r | - | - | 100 | ns |
| Storage (V _{CC} = 30 V, I _C = 750 mA, I _{B1} = 15 mA) | t _s | - | - | 1050 | ns |
| Fall (V _{CC} = 30 V, I _C = 750 mA, I _{B1} = 15 mA) | t _f | - | - | 100 | ns |

3. Pulsed Condition: Pulse Width = 300 μsec, Duty Cycle ≤ 2%.

NSS40501UW3T2G

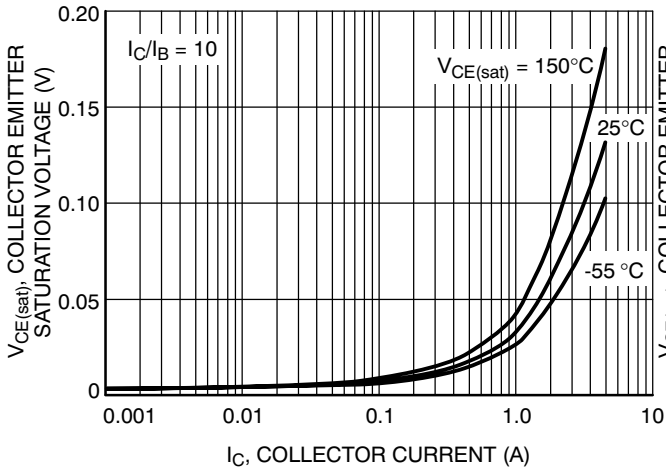

Figure 1. Collector Emitter Saturation Voltage vs. Collector Current

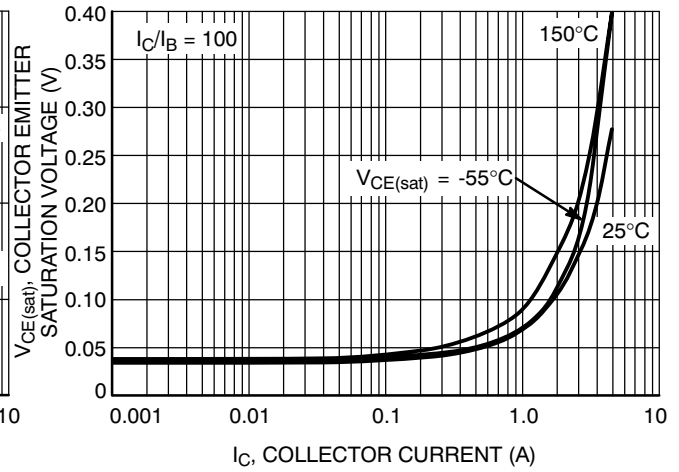

Figure 2. Collector Emitter Saturation Voltage vs. Collector Current

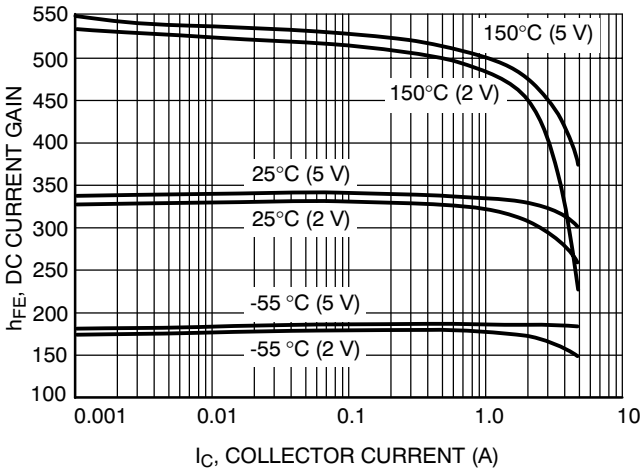

Figure 3. DC Current Gain vs. Collector Current

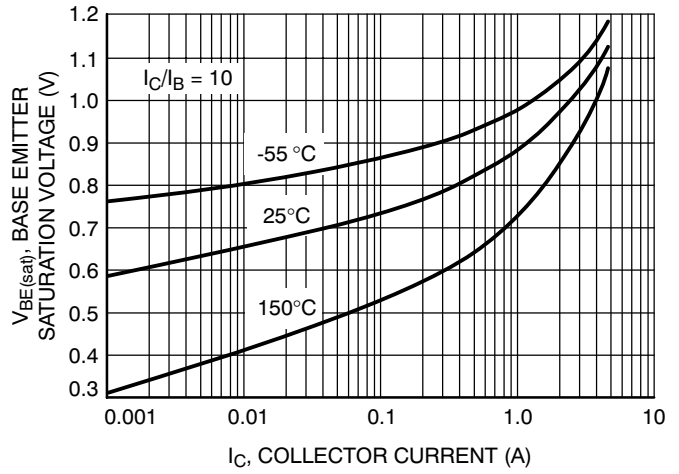

Figure 4. Base Emitter Saturation Voltage vs. Collector Current

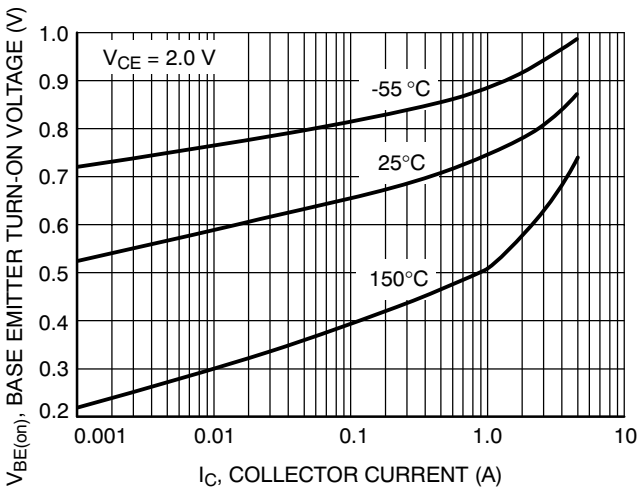

Figure 5. Base Emitter Turn-On Voltage vs. Collector Current

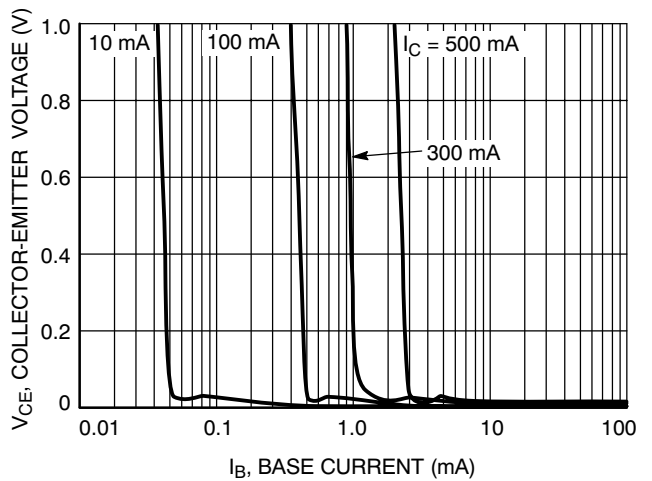

Figure 6. Saturation Region

NSS40501UW3T2G

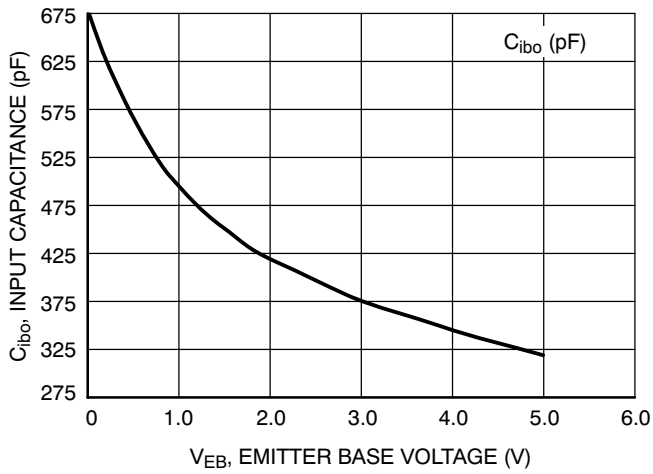

Figure 7. Input Capacitance

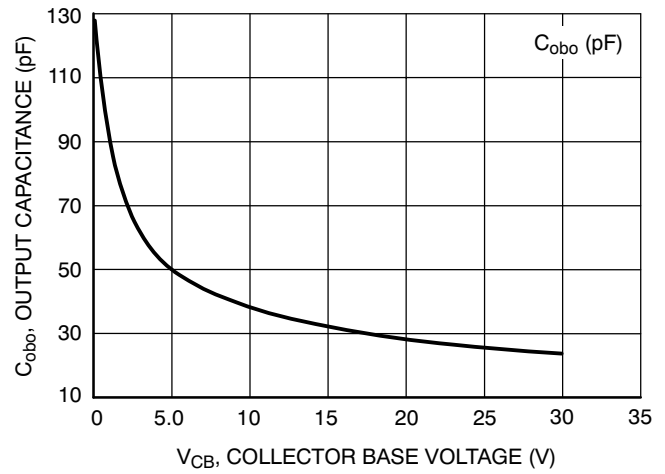

Figure 8. Output Capacitance

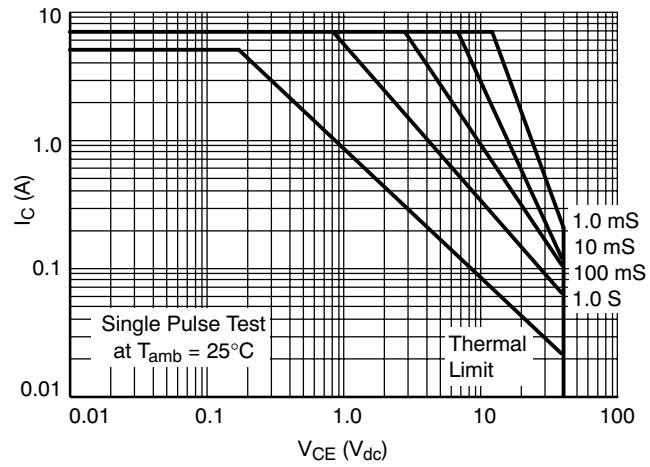
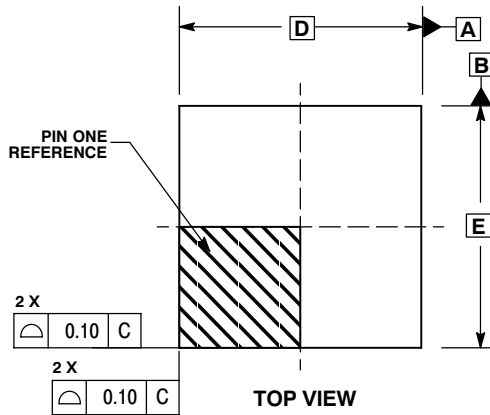

Figure 9. Safe Operating Area

NSS40501UW3T2G

PACKAGE DIMENSIONS

WDFN3
CASE 506AU-01
ISSUE 0



NOTES:

1. DIMENSIONING AND TOLERANCING PER ASME Y14.5M, 1994 .
2. CONTROLLING DIMENSION: MILLIMETERS.
3. DIMENSION b APPLIES TO PLATED TERMINAL AND IS MEASURED BETWEEN 0.25 AND 0.30 MM FROM TERMINAL.
4. COPLANARITY APPLIES TO THE EXPOSED PAD AS WELL AS THE TERMINALS.

| DIM | MILLIMETERS | | | INCHES | | |
|-----|-------------|----------|------|--------|-----------|-------|
| | MIN | NOM | MAX | MIN | NOM | MAX |
| A | 0.70 | 0.75 | 0.80 | 0.028 | 0.030 | 0.031 |
| A1 | 0.00 | | 0.05 | 0.000 | | 0.002 |
| A3 | | 0.20 REF | | | 0.008 REF | |
| b | 0.25 | 0.30 | 0.35 | 0.010 | 0.012 | 0.014 |
| D | | 2.00 BSC | | | 0.079 BSC | |
| D2 | 1.40 | 1.50 | 1.60 | 0.055 | 0.059 | 0.063 |
| E | | 2.00 BSC | | | 0.079 BSC | |
| E2 | 0.90 | 1.00 | 1.10 | 0.035 | 0.039 | 0.043 |
| e | | 1.30 BSC | | | 0.051 BSC | |
| K | | 0.35 REF | | | 0.014 REF | |
| L | 0.35 | 0.40 | 0.45 | 0.014 | 0.016 | 0.018 |

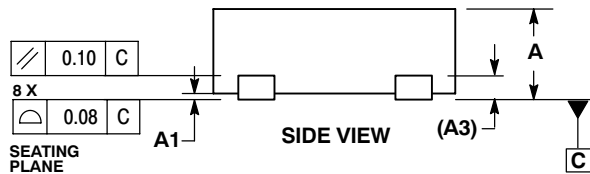

SOLDERING FOOTPRINT*

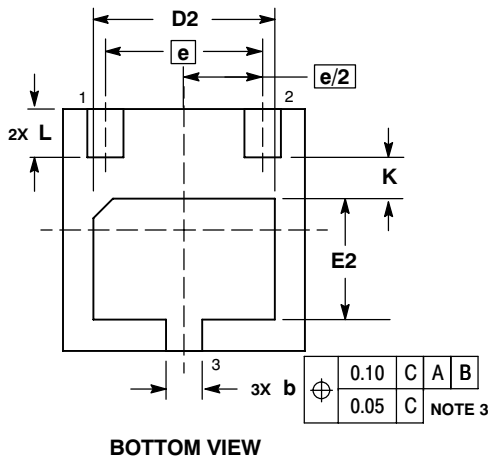
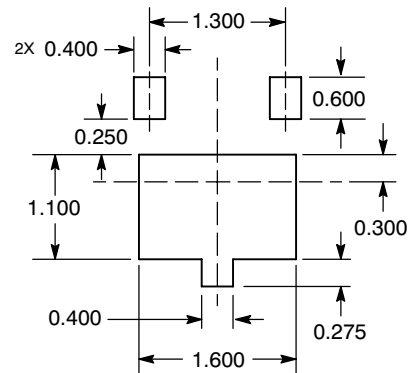

*For additional information on our Pb-Free strategy and soldering details, please download the ON Semiconductor Soldering and Mounting Techniques Reference Manual, SOLDERRM/D.

ON Semiconductor and are registered trademarks of Semiconductor Components Industries, LLC (SCILLC). SCILLC reserves the right to make changes without further notice to any products herein. SCILLC makes no warranty, representation or guarantee regarding the suitability of its products for any particular purpose, nor does SCILLC assume any liability arising out of the application or use of any product or circuit, and specifically disclaims any and all liability, including without limitation special, consequential or incidental damages. "Typical" parameters which may be provided in SCILLC data sheets and/or specifications can and do vary in different applications and actual performance may vary over time. All operating parameters, including "Typicals" must be validated for each customer application by customer's technical experts. SCILLC does not convey any license under its patent rights nor the rights of others. SCILLC products are not designed, intended, or authorized for use as components in systems intended for surgical implant into the body, or other applications intended to support or sustain life, or for any other application in which the failure of the SCILLC product could create a situation where personal injury or death may occur. Should Buyer purchase or use SCILLC products for any such unintended or unauthorized application, Buyer shall indemnify and hold SCILLC and its officers, employees, subsidiaries, affiliates, and distributors harmless against all claims, costs, damages, and expenses, and reasonable attorney fees arising out of, directly or indirectly, any claim of personal injury or death associated with such unintended or unauthorized use, even if such claim alleges that SCILLC was negligent regarding the design or manufacture of the part. SCILLC is an Equal Opportunity/Affirmative Action Employer. This literature is subject to all applicable copyright laws and is not for resale in any manner.

PUBLICATION ORDERING INFORMATION

LITERATURE FULFILLMENT:
Literature Distribution Center for ON Semiconductor
P.O. Box 5163, Denver, Colorado 80217 USA
Phone: 303-675-2175 or 800-344-3860 Toll Free USA/Canada
Fax: 303-675-2176 or 800-344-3867 Toll Free USA/Canada
Email: orderlit@onsemi.com

N. American Technical Support: 800-282-9855 Toll Free USA/Canada
Europe, Middle East and Africa Technical Support:
Phone: 421 33 790 2910
Japan Customer Focus Center
Phone: 81-3-5773-3850

ON Semiconductor Website: www.onsemi.com
Order Literature: <http://www.onsemi.com/orderlit>
For additional information, please contact your local Sales Representative