

# NCP51198

## 1.5A DDR Memory Termination Regulator

The NCP51198 is a simple, cost-effective, high-speed linear regulator designed to generate the  $V_{TT}$  termination voltage rail for DDR-I, DDR-II and DDR-III memory. The regulator is capable of actively sourcing or sinking up to  $\pm 1.5$  A for DDR-I, or up to  $\pm 0.5$  A for DDR-II /-III while regulating the output voltage to within  $\pm 30$  mV.

The output termination voltage is tightly regulated to track  $V_{TT} = (V_{DDQ} / 2)$  over the entire current range.

The NCP51198 incorporates a high-speed differential amplifier to provide ultra-fast response to line and load transients. Other features include extremely low initial offset voltage, excellent load regulation, source/sink soft-start and on-chip thermal shut-down protection.

The NCP51198 features the power-saving Suspend To Ram (STR) function which will tri-state the regulator output and lower the quiescent current drawn when the /SS pin is pulled low.

The NCP51198 is available in a SOIC-8 Exposed Pad package.

### Features

- Generate DDR Memory Termination Voltage ( $V_{TT}$ )
- For DDR-I, DDR-II, DDR-III Source / Sink Currents
- Supports DDR-I to  $\pm 1.5$  A, DDR-II to  $\pm 0.5$  A (peak)
- Integrated Power MOSFETs with Thermal Protection
- Stable with 10  $\mu$ F Ceramic  $V_{TT}$  Capacitor
- High Accuracy Output Voltage at Full-Load
- Minimal External Component Count
- Shutdown for Standby or Suspend to RAM (STR) mode
- Built-in Soft Start
- These are Pb-Free Devices

### Applications

- Desktop PC's, Notebooks, and Workstations
- Graphics Card DDR Memory Termination
- Set Top Boxes, Digital TV's, Printers
- Embedded Systems
- Active Bus Termination



ON Semiconductor®

<http://onsemi.com>

### MARKING DIAGRAM



SOIC8-NB EP  
PD SUFFIX  
CASE 751BU

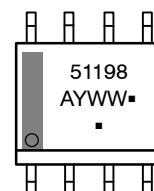

51198 = Specific Device Code  
A = Assembly Location  
Y = Year  
WW = Work Week  
▪ = Pb-Free Package

### PIN CONNECTION

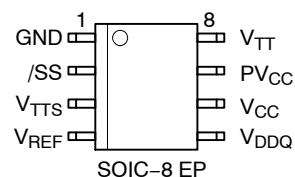

### ORDERING INFORMATION

Device	Package	Shipping†
NCP51198PDR2G	SOIC-8*	2500 / Tape & Reel

†For information on tape and reel specifications, including part orientation and tape sizes, please refer to our Tape and Reel Packaging Specifications Brochure, BRD8011/D.

\*These packages are inherently Pb-Free.

# NCP51198

## 1.5 A, DDR-I /-II /-III TERMINATION REGULATOR

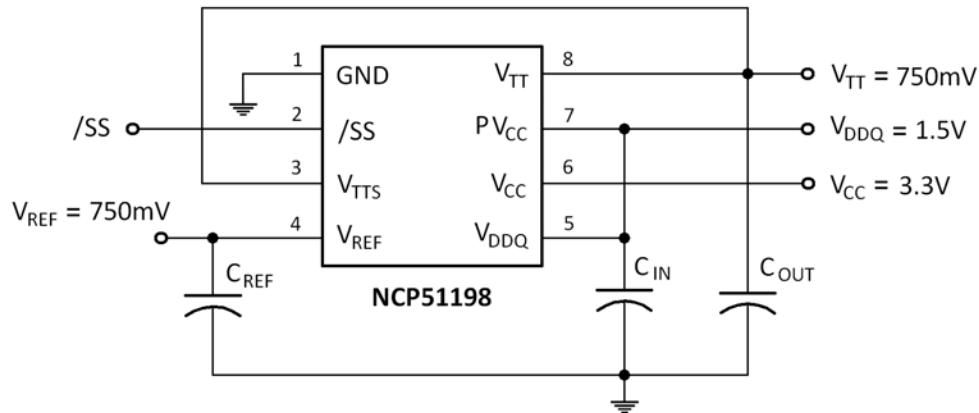

Figure 1. Typical Application Schematic

### PIN FUNCTION DESCRIPTION – NCP51198

Pin Number SO8-EP	Pin Name	Pin Function
1	GND	Common Ground.
2	/SS	Suspend Shutdown supports Suspend To RAM function. CMOS compatible input sets $V_{TT}$ output to high impedance state. Logic HI = Enable, Logic LO = Shutdown.
3	$V_{TTS}$	$V_{TTS}$ is the $V_{TT}$ sense input.
4	$V_{REF}$	$V_{REF}$ is an output pin that provides the buffered output of the internal reference voltage equal to half of $V_{DDQ}$ . Two resistors dividing down the $V_{DDQ}$ voltage on the pin to create the regulated output voltage.
5	$V_{DDQ}$	The $V_{DDQ}$ pin is an input pin for creating the internal reference voltage to regulate $V_{TT}$ . The $V_{DDQ}$ voltage is connected to an internal resistor divider. The central tap of resistor divider ( $V_{DDQ}/2$ ) is connected to the internal voltage buffer, which output is connected to $V_{REF}$ pin and the non-inverting input of the error amplifier as the reference voltage.
6	$V_{CC}$	Power for the analog control circuitry.
7	$PV_{CC}$	The $PV_{CC}$ pin provides the rail voltage from where the $V_{TT}$ pin draws load current. There is a limitation between $V_{CC}$ and $PV_{CC}$ . The $PV_{CC}$ voltage must be less or equal to the $V_{CC}$ voltage to ensure the correct output voltage regulation. The $V_{TT}$ source current capability is dependent on $PV_{CC}$ voltage. The higher the voltage on $PV_{CC}$ , the higher the source current.
8	$V_{TT}$	Regulator output voltage capable of sinking and sourcing current while regulating the output rail.
	THERMAL PAD	Pad for thermal connection. The exposed pad must be connected to the ground plane using multiple vias for maximum power dissipation performance.

# NCP51198

## ABSOLUTE MAXIMUM RATINGS

Rating	Symbol	Value	Unit
$V_{CC}, PV_{CC}, V_{DDQ}, /SS$ to GND (Note 1)		-0.3 to +6	V
Storage Temperature	$T_{stg}$	-65 to +150	°C
Operating Junction Temperature Range	$T_J$	-40 to +125	°C
Thermal Characteristics, SO8-EP Thermal Resistance, Junction-to-Air Power Rating at 25°C ambient = 2.3 W, derate 23 mW/°C	$R_{\theta JA}$	43	°C/W
ESD Capability, Human Body Model (Note 2)	ESD <sub>HBM</sub>	2000	V
ESD Capability, Machine Model (Note 2)	ESD <sub>MM</sub>	150	V

Stresses exceeding Maximum Ratings may damage the device. Maximum Ratings are stress ratings only. Functional operation above the Recommended Operating Conditions is not implied. Extended exposure to stresses above the Recommended Operating Conditions may affect device reliability.

- No pin to exceed  $V_{CC}$ . Refer to ELECTRICAL CHARACTERISTICS and APPLICATION INFORMATION for Safe Operating Area.
- This device series incorporates ESD protection and is tested by the following method:  
ESD Human Body Model tested per AEC-Q100-002 (EIA/JESD22-A114)  
ESD Machine Model tested per AEC-Q100-003 (EIA/JESD22-A115)  
Latchup Current Maximum Rating tested per JEDEC standard: JESD78.

## RECOMMENDED OPERATING CONDITIONS

Rating	Symbol	Value	Unit
Input Voltage	$V_{CC}$	2.2 to 5.5	V
Bias Supply Voltage	$PV_{CC}$	1.5 to 2.5	V
Reference Input Voltage	$V_{DDQ}$	1.35 to 2.7	V

## ELECTRICAL CHARACTERISTICS

-40°C ≤  $T_J$  ≤ 125°C;  $V_{CC} = PV_{CC} = V_{DDQ} = 2.5$  V; unless otherwise noted. Typical values are at  $T_J = +25$ °C

Parameter	Condition	Symbol	Min	Typ	Max	Unit
Reference Voltage (DDR I) $I_{REF} = 0$ mA (unloaded)	$PV_{CC} = V_{DDQ} = 2.3$ V $= 2.5$ V $= 2.7$ V	$V_{REF}$ (DDR-I)	1.125 1.225 1.325	1.151 1.251 1.351	1.175 1.275 1.375	V
Reference Voltage (DDR II) $I_{REF} = 0$ mA (unloaded)	$PV_{CC} = V_{DDQ} = 1.7$ V $= 1.8$ V $= 1.9$ V	$V_{REF}$ (DDR-II)	0.830 0.880 0.925	0.851 0.901 0.951	0.880 0.930 0.975	V
Reference Voltage (DDR III) $I_{REF} = 0$ mA (unloaded)	$PV_{CC} = V_{DDQ} = 1.35$ V $= 1.5$ V $= 1.6$ V	$V_{REF}$ (DDR-III)	0.660 0.735 0.785	0.676 0.751 0.801	0.695 0.770 0.820	V
$V_{REF}$ - Output Impedance	$I_{REF} = -30$ μA to +30 μA	$Z_{REF}$		2.5		kΩ
$V_{TT}$ Output Voltage (DDR-I)	$I_{OUT} = 0$ A $PV_{CC} = V_{DDQ} = 2.3$ V $PV_{CC} = V_{DDQ} = 2.5$ V $PV_{CC} = V_{DDQ} = 2.7$ V	$V_{TT}$ (DDR-I)	- 1.112 1.202 1.312	- 1.150 1.250 1.350	- 1.182 1.282 1.382	V
	$I_{OUT} = +1.5$ A $PV_{CC} = V_{DDQ} = 2.3$ V $PV_{CC} = V_{DDQ} = 2.5$ V $PV_{CC} = V_{DDQ} = 2.7$ V		- 1.115 1.215 1.315	- 1.150 1.250 1.350	- 1.185 1.285 1.385	
	$I_{OUT} = -1.5$ A $PV_{CC} = V_{DDQ} = 2.3$ V $PV_{CC} = V_{DDQ} = 2.5$ V $PV_{CC} = V_{DDQ} = 2.7$ V		- 1.117 1.217 1.317	- 1.150 1.250 1.350	- 1.182 1.282 1.382	

# NCP51198

## ELECTRICAL CHARACTERISTICS

-40°C ≤ T<sub>J</sub> ≤ 125°C; V<sub>CC</sub> = PV<sub>CC</sub> = V<sub>DDQ</sub> = 2.5 V; unless otherwise noted. Typical values are at T<sub>J</sub> = +25°C

Parameter	Condition	Symbol	Min	Typ	Max	Unit
V <sub>TT</sub> Output Voltage (DDR-II)	I <sub>OUT</sub> = 0 A PV <sub>CC</sub> = V <sub>DDQ</sub> = 1.7 V PV <sub>CC</sub> = V <sub>DDQ</sub> = 1.8 V PV <sub>CC</sub> = V <sub>DDQ</sub> = 1.9 V	V <sub>TT</sub> (DDR-II)	- 0.816 0.866 0.916	- 0.850 0.900 0.950	- 0.881 0.931 0.981	V
	I <sub>OUT</sub> = +0.5 A PV <sub>CC</sub> = V <sub>DDQ</sub> = 1.7 V PV <sub>CC</sub> = V <sub>DDQ</sub> = 1.8 V PV <sub>CC</sub> = V <sub>DDQ</sub> = 1.9 V	V <sub>TT</sub> (DDR-II)	- 0.815 0.863 0.914	- 0.851 0.900 0.950	- 0.885 0.933 0.984	
	I <sub>OUT</sub> = -0.5 A PV <sub>CC</sub> = V <sub>DDQ</sub> = 1.7 V PV <sub>CC</sub> = V <sub>DDQ</sub> = 1.8 V PV <sub>CC</sub> = V <sub>DDQ</sub> = 1.9 V	V <sub>TT</sub> (DDR-II)	- 0.814 0.862 0.913	- 0.850 0.900 0.950	- 0.884 0.932 0.983	
V <sub>TT</sub> Output Voltage (DDR-III)	I <sub>OUT</sub> = 0 A PV <sub>CC</sub> = V <sub>DDQ</sub> = 1.35 V PV <sub>CC</sub> = V <sub>DDQ</sub> = 1.5 V PV <sub>CC</sub> = V <sub>DDQ</sub> = 1.6 V	V <sub>TT</sub> (DDR-III)	- 0.650 0.725 0.775	- 0.675 0.750 0.800	- 0.700 0.775 0.825	V
	I <sub>OUT</sub> = +0.2 A, PV <sub>CC</sub> = V <sub>DDQ</sub> = 1.35 V I <sub>OUT</sub> = -0.2 A, PV <sub>CC</sub> = V <sub>DDQ</sub> = 1.35 V	V <sub>TT</sub> (DDR-III)	- 0.649 - 0.640	- 0.675 - 0.675	- 0.700 - 0.700	
	I <sub>OUT</sub> = +0.4 A, PV <sub>CC</sub> = V <sub>DDQ</sub> = 1.5 V I <sub>OUT</sub> = -0.4 A, PV <sub>CC</sub> = V <sub>DDQ</sub> = 1.5 V	V <sub>TT</sub> (DDR-III)	- 0.722 - 0.725	- 0.751 - 0.750	- 0.776 - 0.774	
	I <sub>OUT</sub> = +0.5 A, PV <sub>CC</sub> = V <sub>DDQ</sub> = 1.6 V I <sub>OUT</sub> = -0.5 A, PV <sub>CC</sub> = V <sub>DDQ</sub> = 1.6 V	V <sub>TT</sub> (DDR-III)	- 0.773 - 0.775	- 0.801 - 0.800	- 0.827 - 0.824	
V <sub>TT</sub> Output Offset Voltage	I <sub>OUT</sub> = ±1.5 A, PV <sub>CC</sub> = V <sub>DDQ</sub> = 2.5 V	V <sub>OS</sub> (DDR-I)	-30	0	+30	mV
	I <sub>OUT</sub> = ±0.5 A, PV <sub>CC</sub> = V <sub>DDQ</sub> = 1.8 V	V <sub>OS</sub> (DDR-II)	-30	0	+30	
	I <sub>OUT</sub> = ±0.5 A, PV <sub>CC</sub> = V <sub>DDQ</sub> = 1.5 V	V <sub>OS</sub> (DDR-III)	-30	0	+30	
Quiescent Current	I <sub>OUT</sub> = 0 A	I <sub>Q</sub>		380	500	μA
V <sub>DDQ</sub> Input Impedance		Z <sub>VDDQ</sub>		100		kΩ
/SS Leakage Current	/SS = 0 V	I <sub>L_SS</sub>		2	5	μA
Quiescent Current in Suspend Shutdown	/SS = 0 V	I <sub>Q_SS</sub>		115	150	μA
Suspend Shutdown Threshold		V <sub>IH</sub>	1.9			V
		V <sub>IL</sub>			0.8	
V <sub>TT</sub> leakage Current in Suspend Shutdown	/SS = 0 V, V <sub>TT</sub> = 1.25 V	I <sub>L_VTT</sub>		1	10	μA
V <sub>TTS</sub> Current		I <sub>TTS</sub>		13		nA
Thermal Shutdown Temperature		T <sub>SD</sub>		165		°C
Thermal Shutdown Hysteresis		T <sub>SH</sub>		10		°C

TYPICAL PERFORMANCE CHARACTERISTICS

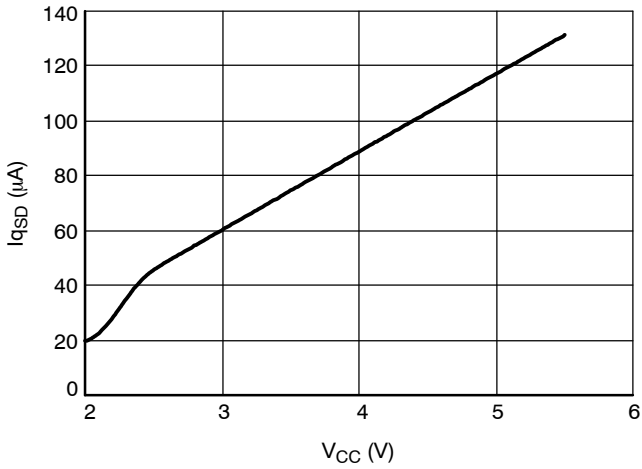

Figure 2. I<sub>qSD</sub> vs. V<sub>CC</sub>

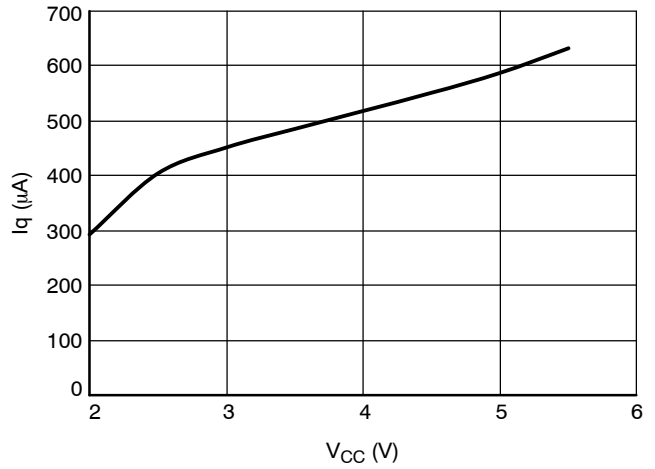

Figure 3. I<sub>q</sub> vs. V<sub>CC</sub>

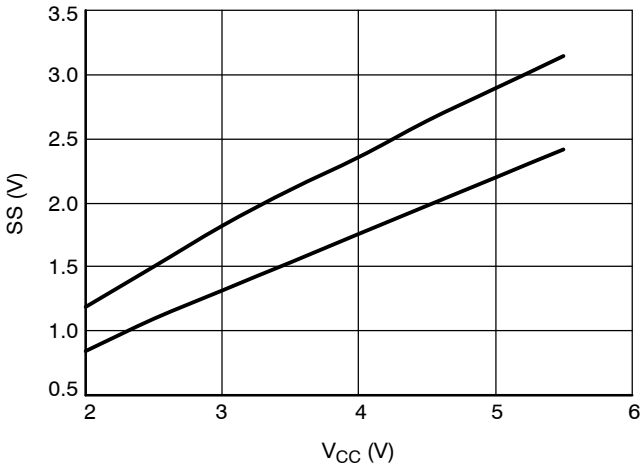

Figure 4. V<sub>IH</sub> and V<sub>IL</sub>

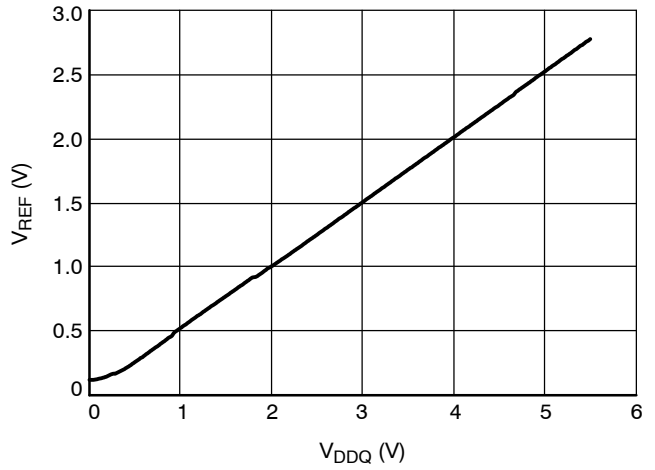

Figure 5. V<sub>REF</sub> vs. V<sub>DDQ</sub>

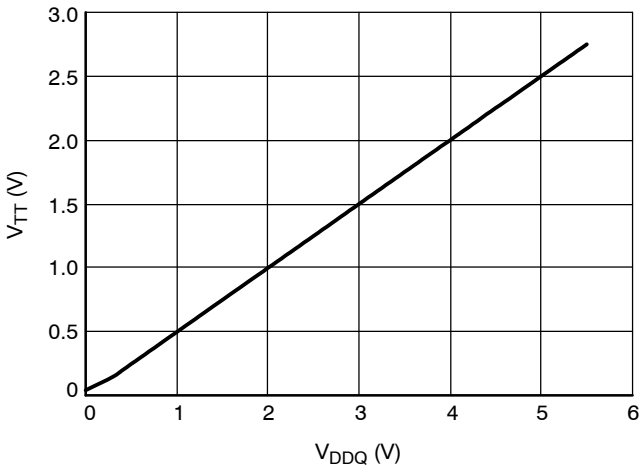

Figure 6. V<sub>TT</sub> vs. V<sub>DDQ</sub>

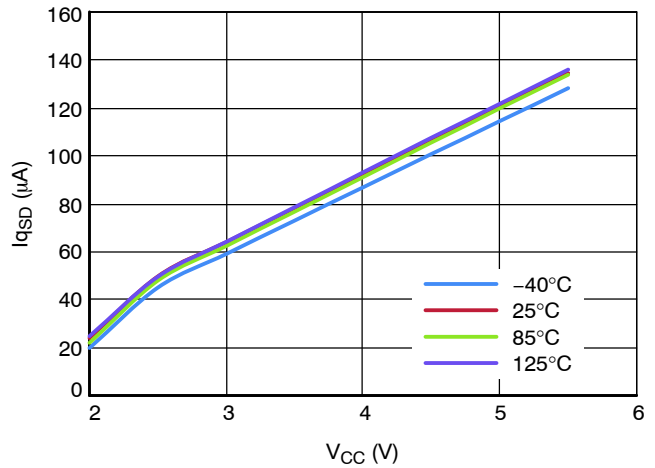

Figure 7. I<sub>qSD</sub> vs. V<sub>CC</sub> over Temperature

TYPICAL PERFORMANCE CHARACTERISTICS

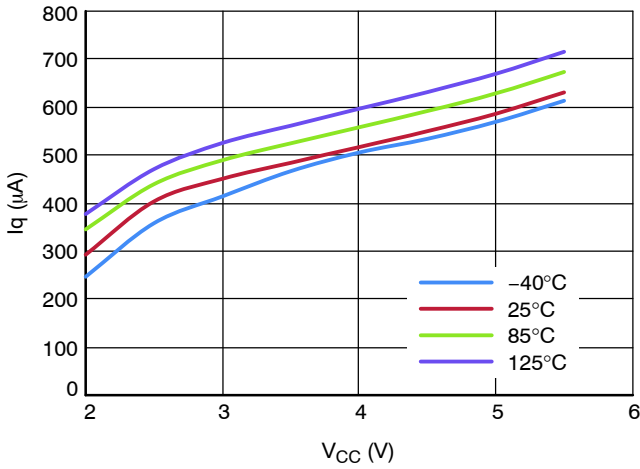

Figure 8. Iq vs. V<sub>CC</sub> over Temperature

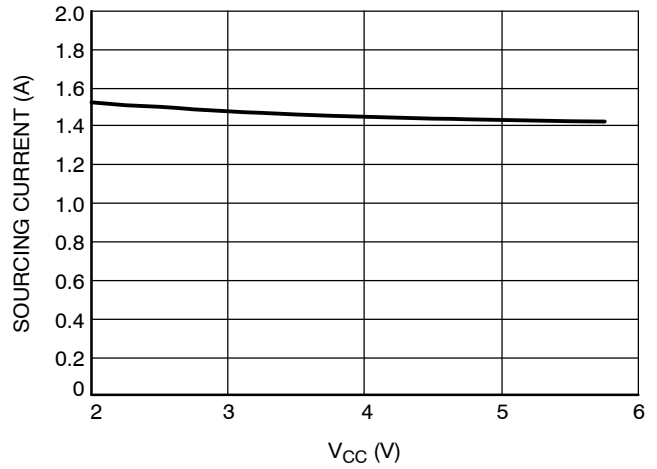

Figure 9. Maximum Sourcing Current vs. V<sub>CC</sub>  
(V<sub>DDQ</sub> = PV<sub>CC</sub> = 1.8 V)

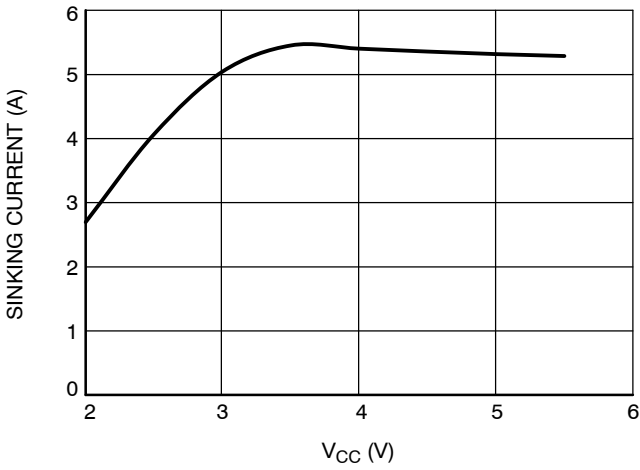

Figure 10. Maximum Sinking Current vs. V<sub>CC</sub>  
(V<sub>DDQ</sub> = PV<sub>CC</sub> = 1.8 V)

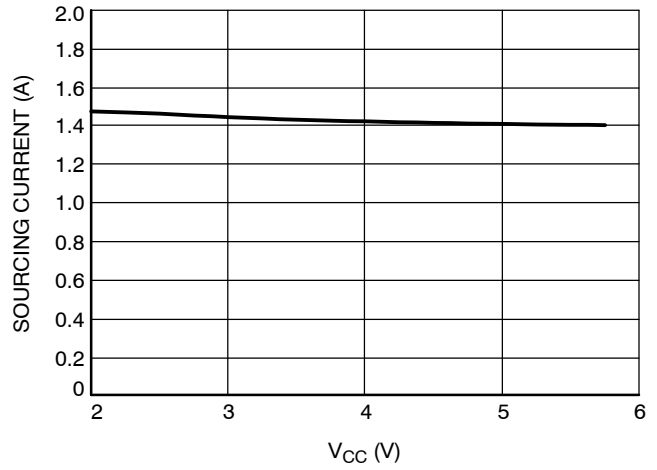

Figure 11. Maximum Sourcing Current vs. V<sub>CC</sub>  
(V<sub>DDQ</sub> = 2.5 V, PV<sub>CC</sub> = 1.8 V)

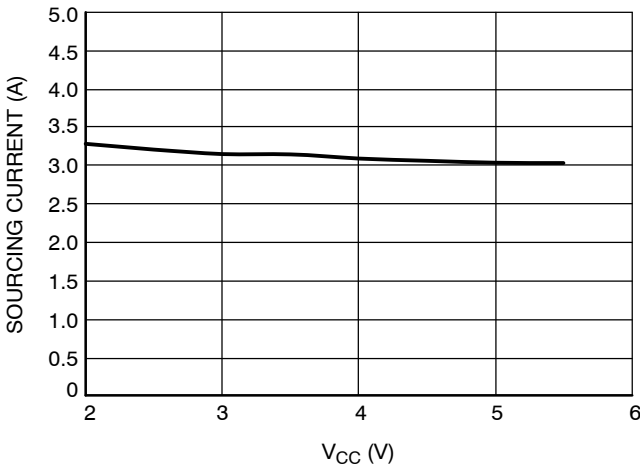

Figure 12. Maximum Sourcing Current vs. V<sub>CC</sub>  
(V<sub>DDQ</sub> = PV<sub>CC</sub> = 2.5 V)

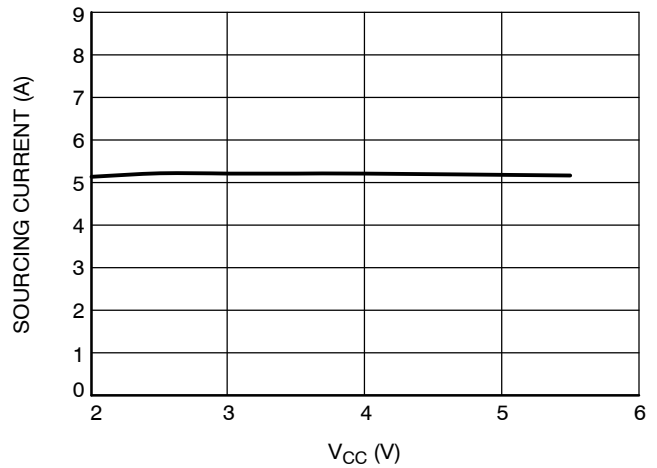

Figure 13. Maximum Sourcing Current vs. V<sub>CC</sub>  
(V<sub>DDQ</sub> = 2.5 V, PV<sub>CC</sub> = 3.3 V)

TYPICAL PERFORMANCE CHARACTERISTICS

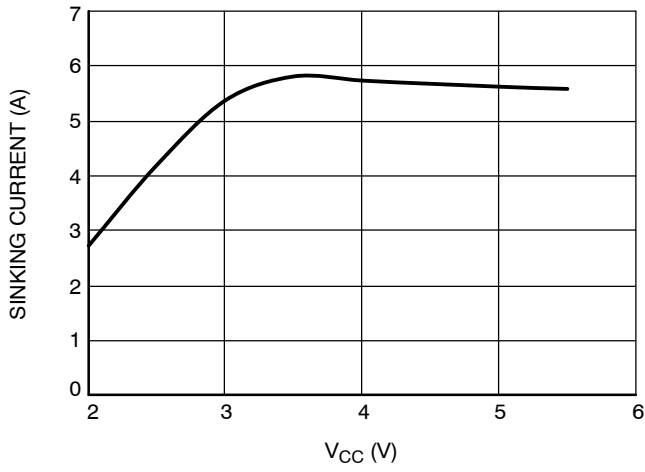

Figure 14. Maximum Sinking Current vs. V<sub>CC</sub>  
(V<sub>DDQ</sub> = PV<sub>CC</sub> = 2.5 V)

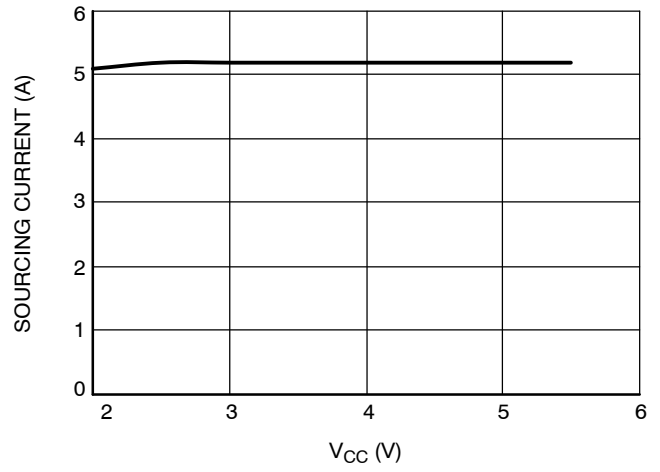

Figure 15. Maximum Sourcing Current vs. V<sub>CC</sub>  
(V<sub>DDQ</sub> = 1.8 V, PV<sub>CC</sub> = 3.3 V)

## APPLICATIONS INFORMATION

**General**

The NCP51198 is a bus termination, linear regulator designed to meet the JEDEC requirements for DDR-I, DDR-II and DDR-III memory termination. The NCP51198 is capable of sourcing and sinking current while accurately tracking and regulating the  $V_{TT}$  output voltage equal to  $(V_{DDQ} / 2)$ . The output stage has been designed to maintain excellent load regulation and preventing shoot-through. The NCP51198 uses two distinct power rails to separate the analog circuitry from the power output stage and decrease internal power dissipation.

**Supply Voltage Inputs**

For added flexibility, separate input pins ( $V_{CC}$  and  $PV_{CC}$ ) are provided for each required supply input.  $V_{CC}$  is used to supply all the internal control circuitry and  $PV_{CC}$  is used exclusively to provide the rail voltage for the output stage used to create  $V_{TT}$ . These pins have the capability to work off separate supplies with the condition that  $V_{CC}$  is always greater than or equal to  $PV_{CC}$ , and should always be used with either a 1.8 V or 2.5 V rail. If the junction temperature exceeds the thermal shutdown threshold, the part will enter a shutdown state identical to the manual shutdown where  $V_{TT}$  is tri-stated and  $V_{REF}$  remains active. Lower voltage rails, such as 1.5 V can be used but will reduce the maximum available output current.

**Generation of Internal Voltage Reference**

$V_{DDQ}$  is the input used to create the internal reference voltage for regulating  $V_{TT}$ . The reference voltage is generated from a resistor divider of two internal 50 k $\Omega$  resistors. This guarantees that  $V_{TT}$  will precisely track  $(V_{DDQ} / 2)$ . The optimal implementation of the  $V_{DDQ}$  input pin is as a remote sense. This can be achieved by connecting  $V_{DDQ}$  directly to the 1.8 V rail at the DIMM memory module instead of connecting it to  $PV_{CC}$ . This ensures that the reference voltage precisely tracks the DDR memory power rail without introducing a large voltage drop due to power traces. For DDR-II applications the  $V_{DDQ}$  input will be 1.8 V, which will create a  $(V_{DDQ} / 2) = 0.9$  V termination voltage at the  $V_{TT}$  output.

$V_{REF}$  provides a buffered output of the internal reference voltage  $(V_{DDQ} / 2)$ . For improved performance, an output bypass capacitor can be placed, close to the pin, to help reduce any potential stray noise. A ceramic capacitor in the range of 0.01  $\mu$ F to 0.1  $\mu$ F is recommended. The  $V_{REF}$  output remains active during the shutdown state and thermal shutdown events for the suspend to RAM functionality.

**Remote Voltage Feedback Sensing**

The purpose of the  $V_{TTS}$  sense pin is to provide improved remote load regulation. In most motherboard applications, the termination resistors will connect to  $V_{TT}$  in a long plane. If the output voltage was regulated only at the output of the

NCP51198, then any long traces will generate a significant IR drop resulting in a sagging termination voltage at one end of the bus than the other. The  $V_{TTS}$  pin can be used to improve performance by connecting it to the middle of the bus. This will provide better power distribution across the entire termination bus. If remote load regulation is not used, then the  $V_{TTS}$  pin must still be connected to  $V_{TT}$ . Care should be taken when a long  $V_{TTS}$  trace is implemented in close proximity to the memory. Noise pickup in the  $V_{TTS}$  trace can cause problems with precise regulation of  $V_{TT}$ . A small 0.1  $\mu$ F ceramic capacitor placed next to the  $V_{TTS}$  pin can help filter out any high frequency noise and thereby keeping the  $V_{TT}$  power rail in spec.

**Regulator Shutdown Function**

The NCP51198 contains an active low enable pin ( $/SS$ ) that can be used for suspend to RAM functionality. In this condition the  $V_{TT}$  output will tri-state, with the  $V_{REF}$  output remaining active in order to provide a constant reference signal for the memory and chipset. During shutdown,  $V_{TT}$  should not be exposed to voltages that exceed  $PV_{CC}$ .

With the enable pin asserted low the quiescent current of the NCP51198 will drop, however the  $V_{DDQ}$  input pin will always draw a constant current due to the integrated 100 k $\Omega$  impedance used for generating the internal reference. Therefore, to calculate the total power loss in shutdown, both currents need to be considered. The enable pin also has an internal pull-up current. Therefore, to turn the part on, the enable pin can either be connected to  $V_{CC}$  or left open.

**Termination Voltage Output Regulation**

$V_{TT}$  is the regulated output that is used to terminate the bus resistors. It is capable of sourcing and sinking current while regulating the output precisely to  $V_{DDQ} / 2$ . The NCP51198 is designed to handle continuous currents of up to  $\pm 1.5$  A with excellent load regulation. If a transient is expected to last above the maximum continuous current rating for a significant amount of time, then the bulk output capacitor should be sized large enough to prevent an excessive voltage drop.

**Thermal Shutdown with Hysteresis**

If the NCP51198 is to operate in elevated temperatures for long durations, care should be taken to ensure that the maximum operating junction temperature is not exceeded. To guarantee safe operation, the NCP51198 provides on-chip thermal shutdown protection. When the chip junction temperature exceeds 165°C (typical) the part will shutdown. When the junction temperature falls back to 155°C (typical) the device resumes normal operation. If the junction temperature exceeds the thermal shutdown threshold,  $V_{TT}$  will tri-state until the part returns below the temperature hysteresis trip-point.



# NCP51198

## PACKAGE DIMENSIONS

### SOIC8-NB EP CASE 751BU ISSUE B

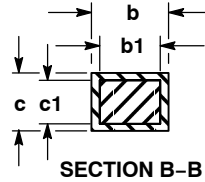
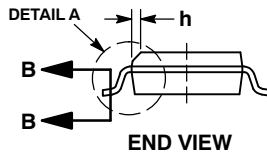
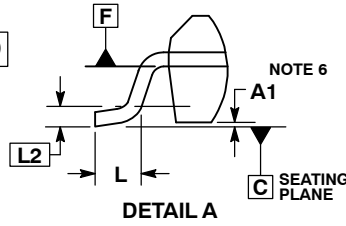
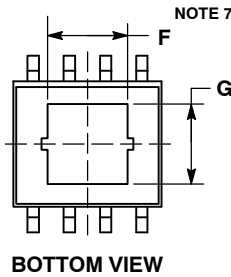
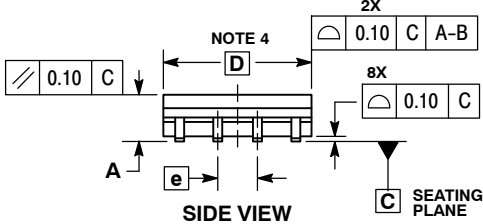
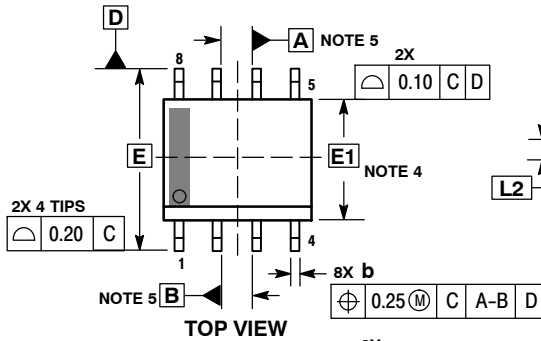

### RECOMMENDED SOLDERING FOOTPRINT

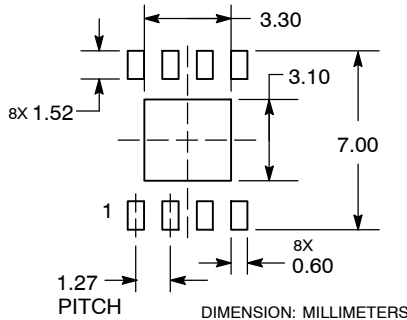

#### NOTES:

1. DIMENSIONING AND TOLERANCING PER ASME Y14.5M, 1994.
2. CONTROLLING DIMENSION: MILLIMETERS.
3. DIMENSION b DOES NOT INCLUDE DAMBAR PROTRUSION. ALLOWABLE PROTRUSION SHALL BE 0.10mm IN EXCESS OF MAXIMUM MATERIAL CONDITION.
4. DIMENSION D DOES NOT INCLUDE MOLD FLASH, PROTRUSIONS, OR GATE BURRS. MOLD FLASH, PROTRUSIONS, OR GATE BURRS SHALL NOT EXCEED 0.15mm PER SIDE. DIMENSION E DOES NOT INCLUDE INTERLEAD FLASH OR PROTRUSION. INTERLEAD FLASH OR PROTRUSION SHALL NOT EXCEED 0.25mm PER SIDE. DIMENSIONS D AND E ARE DETERMINED AT DATUM F.
5. DIMENSIONS A AND B ARE TO BE DETERMINED AT DATUM F.
6. A1 IS DEFINED AS THE VERTICAL DISTANCE FROM THE SEATING PLANE TO THE LOWEST POINT ON THE PACKAGE BODY.
7. TAB CONTOUR MAY VARY MINIMALLY TO INCLUDE TOOLING FEATURES.

DIM	MILLIMETERS	
	MIN	MAX
A	1.35	1.75
A1	---	0.10
b	0.31	0.51
b1	0.28	0.48
c	0.17	0.25
c1	0.17	0.23
D	4.90 BSC	
E	6.00 BSC	
E1	3.90 BSC	
e	1.27 BSC	
F	1.55	3.07
G	1.55	3.07
h	0.25	0.50
L	0.40	1.27
L2	0.25 BSC	

**ON Semiconductor** and  are registered trademarks of Semiconductor Components Industries, LLC (SCILLC). SCILLC owns the rights to a number of patents, trademarks, copyrights, trade secrets, and other intellectual property. A listing of SCILLC's product/patent coverage may be accessed at [www.onsemi.com/site/pdf/Patent-Marking.pdf](http://www.onsemi.com/site/pdf/Patent-Marking.pdf). SCILLC reserves the right to make changes without further notice to any products herein. SCILLC makes no warranty, representation or guarantee regarding the suitability of its products for any particular purpose, nor does SCILLC assume any liability arising out of the application or use of any product or circuit, and specifically disclaims any and all liability, including without limitation special, consequential or incidental damages. "Typical" parameters which may be provided in SCILLC data sheets and/or specifications can and do vary in different applications and actual performance may vary over time. All operating parameters, including "Typicals" must be validated for each customer application by customer's technical experts. SCILLC does not convey any license under its patent rights nor the rights of others. SCILLC products are not designed, intended, or authorized for use as components in systems intended for surgical implant into the body, or other applications intended to support or sustain life, or for any other application in which the failure of the SCILLC product could create a situation where personal injury or death may occur. Should Buyer purchase or use SCILLC products for any such unintended or unauthorized application, Buyer shall indemnify and hold SCILLC and its officers, employees, subsidiaries, affiliates, and distributors harmless against all claims, costs, damages, and expenses, and reasonable attorney fees arising out of, directly or indirectly, any claim of personal injury or death associated with such unintended or unauthorized use, even if such claim alleges that SCILLC was negligent regarding the design or manufacture of the part. SCILLC is an Equal Opportunity/Affirmative Action Employer. This literature is subject to all applicable copyright laws and is not for resale in any manner.

### PUBLICATION ORDERING INFORMATION

**LITERATURE FULFILLMENT:**  
Literature Distribution Center for ON Semiconductor  
P.O. Box 5163, Denver, Colorado 80217 USA  
**Phone:** 303-675-2175 or 800-344-3860 Toll Free USA/Canada  
**Fax:** 303-675-2176 or 800-344-3867 Toll Free USA/Canada  
**Email:** [orderlit@onsemi.com](mailto:orderlit@onsemi.com)

**N. American Technical Support:** 800-282-9855 Toll Free  
USA/Canada  
**Europe, Middle East and Africa Technical Support:**  
Phone: 421 33 790 2910  
**Japan Customer Focus Center**  
Phone: 81-3-5817-1050

**ON Semiconductor Website:** [www.onsemi.com](http://www.onsemi.com)  
**Order Literature:** <http://www.onsemi.com/orderlit>

For additional information, please contact your local Sales Representative