

Ultrafast recovery diode

Main product characteristics

$I_{F(AV)}$	2 A
V_{RRM}	200 V
$T_j(\text{max})$	175° C
$V_F(\text{typ})$	0.7 V
$t_{rr}(\text{typ})$	15 ns

Features and benefits

- Very low conduction losses
- Negligible switching losses
- Low forward and reverse recovery times
- High junction temperature

Description

The STTH2R02 uses ST's new 200 V planar Pt doping technology, and it is specially suited for switching mode base drive and transistor circuits.

Packaged in DO-15, SMA, and SMB, this device is intended for use in low voltage, high frequency inverters, free wheeling and polarity protection.

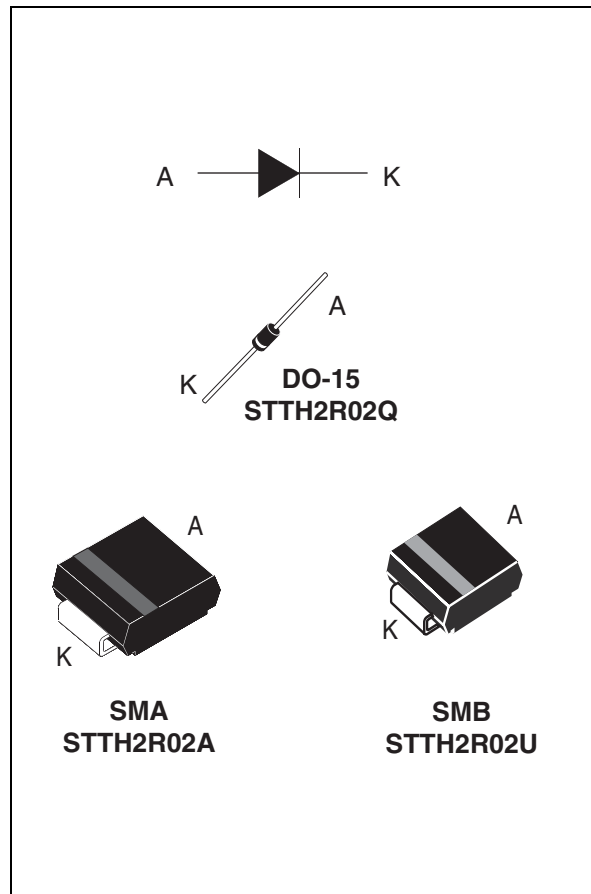

Order codes

Part Number	Marking
STTH2R02Q	STTH2R02
STTH2R02QRL	STTH2R02
STTH2R02A	R2A
STTH2R02U	R2U

1 Characteristics

Table 1. Absolute ratings (limiting values at $T_j = 25^\circ\text{C}$, unless otherwise specified)

Symbol	Parameter		Value	Unit
V_{RRM}	Repetitive peak reverse voltage		200	V
I_{FRM}	Repetitive peak forward current	DO-15 ⁽¹⁾ $t_p = 5 \mu\text{s}, F = 5 \text{ kHz}$	60	A
		SMA, SMB		
$I_{F(RMS)}$	RMS forward current	DO-15	60	A
		SMA, SMB		
$I_{F(AV)}$	Average forward current, $\delta = 0.5$	DO-15 $T_{lead} = 90^\circ\text{C}$	2	A
		SMA, SMB $T_c = 90^\circ\text{C}$		
I_{FSM}	Surge non repetitive forward current	$t_p = 10 \text{ ms}$ Sinusoidal	75	A
T_{stg}	Storage temperature range		-65 to + 175	$^\circ\text{C}$
T_j	Maximum operating junction temperature		175	$^\circ\text{C}$

1. On infinite heatsink with 10 mm lead length

Table 2. Thermal parameters

Symbol	Parameter			Value	Unit
$R_{th(j-c)}$	Junction to lead	Lead Length = 10 mm on infinite heatsink	DO-15	45	$^\circ\text{C/W}$
	Junction to case		SMA, SMB	30	

Table 3. Static electrical characteristics

Symbol	Parameter	Test conditions		Min.	Typ	Max.	Unit
$I_R^{(1)}$	Reverse leakage current	$T_j = 25^\circ\text{C}$	$V_R = V_{RRM}$			3	μA
		$T_j = 125^\circ\text{C}$			2	20	
$V_F^{(2)}$	Forward voltage drop	$T_j = 25^\circ\text{C}$	$I_F = 6 \text{ A}$			1.20	V
		$T_j = 25^\circ\text{C}$			0.89	1.0	
		$T_j = 100^\circ\text{C}$	$I_F = 2 \text{ A}$		0.76	0.85	
		$T_j = 150^\circ\text{C}$			0.70	0.80	

1. Pulse test: $t_p = 5 \text{ ms}, \delta < 2 \%$

2. Pulse test: $t_p = 380 \mu\text{s}, \delta < 2 \%$

To evaluate the conduction losses use the following equation:

$$P = 0.68 \times I_{F(AV)} + 0.06 I_{F(RMS)}^2$$

Table 4. Dynamic characteristics

Symbol	Parameter	Test conditions	Min.	Typ	Max.	Unit
t_{rr}	Reverse recovery time	$I_F = 1\text{ A}$, $di_F/dt = -50\text{ A}/\mu\text{s}$, $V_R = 30\text{ V}$, $T_j = 25^\circ\text{ C}$		23	30	ns
		$I_F = 1\text{ A}$, $di_F/dt = -100\text{ A}/\mu\text{s}$, $V_R = 30\text{ V}$, $T_j = 25^\circ\text{ C}$		15	20	
I_{RM}	Reverse recovery current	$I_F = 2\text{ A}$, $di_F/dt = -200\text{ A}/\mu\text{s}$, $V_R = 160\text{ V}$, $T_j = 125^\circ\text{ C}$		3	4	A
t_{fr}	Forward recovery time	$I_F = 2\text{ A}$, $di_F/dt = 100\text{ A}/\mu\text{s}$ $V_{FR} = 1.1 \times V_{Fmax}$, $T_j = 25^\circ\text{ C}$		40		ns
V_{FP}	Forward recovery voltage	$I_F = 2\text{ A}$, $di_F/dt = 100\text{ A}/\mu\text{s}$, $T_j = 25^\circ\text{ C}$		2.0		V

Figure 1. Peak current versus duty cycle

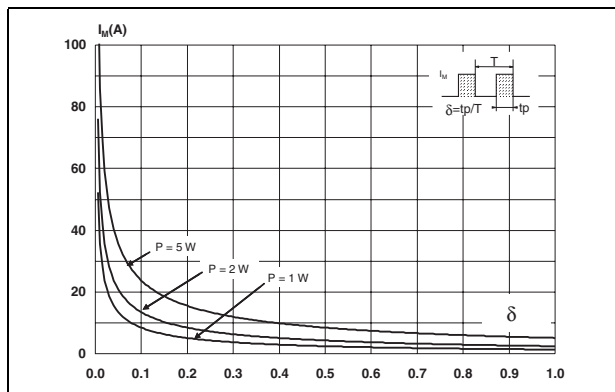

Figure 2. Forward voltage drop versus forward current (typical values)

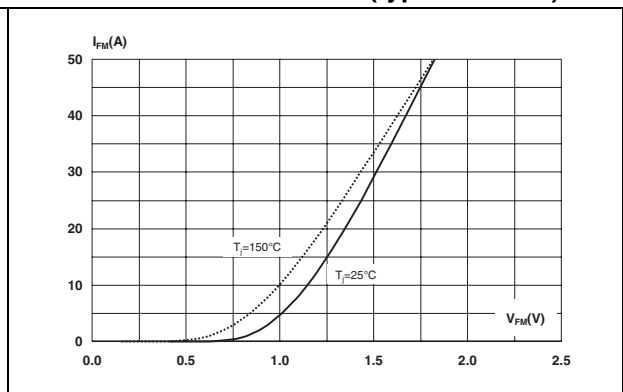

Figure 3. Forward voltage drop versus forward current (maximum values)

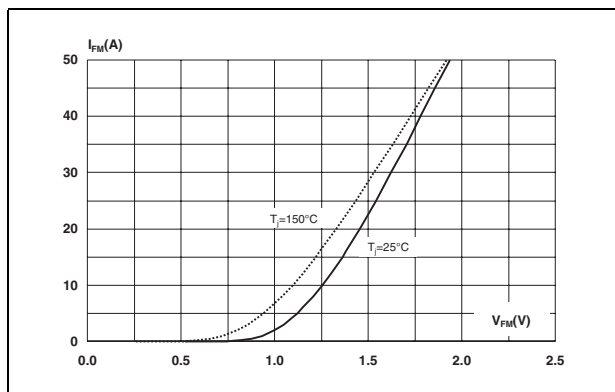

Figure 4. Relative variation of thermal impedance junction to case versus pulse duration (SMA)

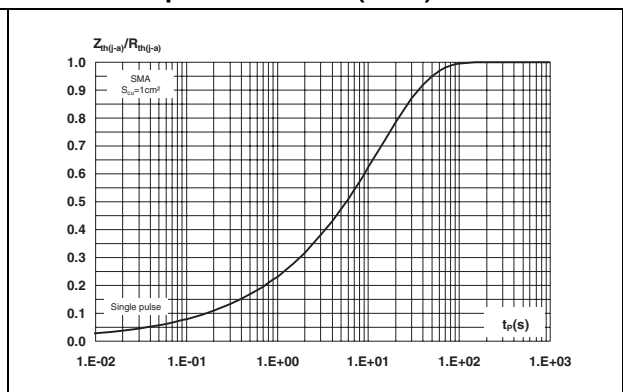

Figure 5. Relative variation of thermal impedance junction to case versus pulse duration (SMB)

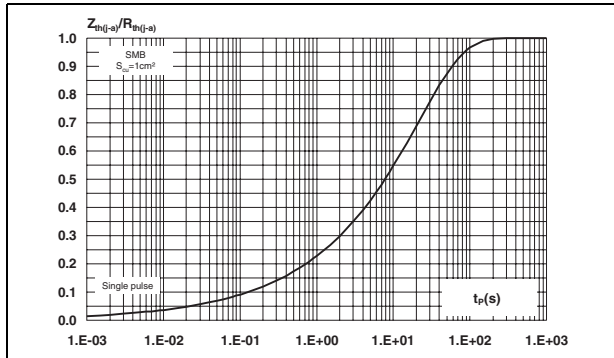

Figure 6. Relative variation of thermal impedance junction to case versus pulse duration (DO-15)

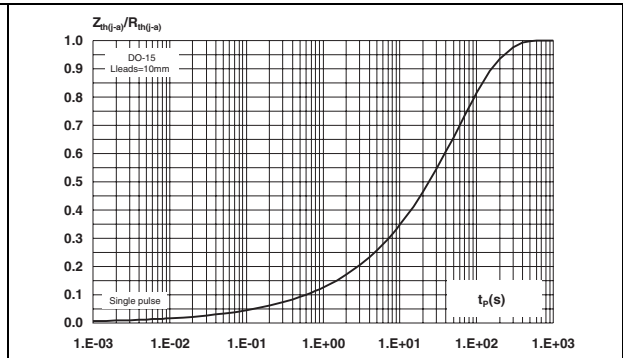

Figure 7. Junction capacitance versus reverse applied voltage (typical values)

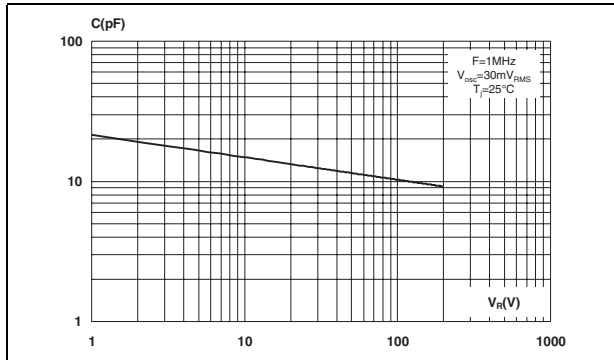

Figure 8. Reverse recovery charges versus di_F/dt (typical values)

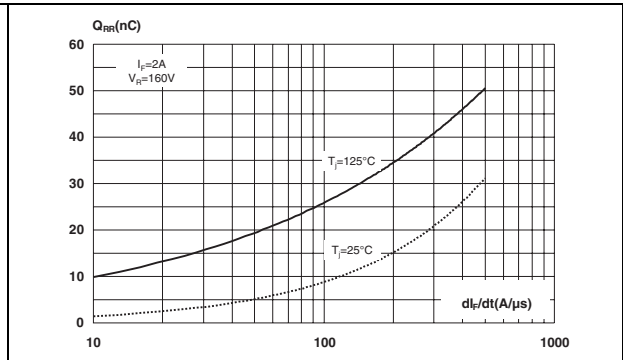

Figure 9. Reverse recovery time versus di_F/dt (typical values)

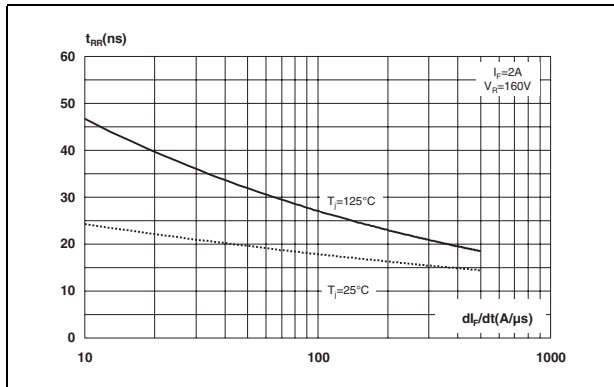

Figure 10. Peak reverse recovery current versus di_F/dt (typical values)

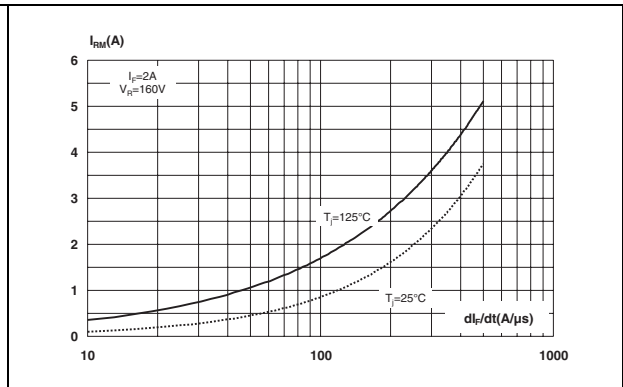

Figure 11. Dynamic parameters versus junction temperature

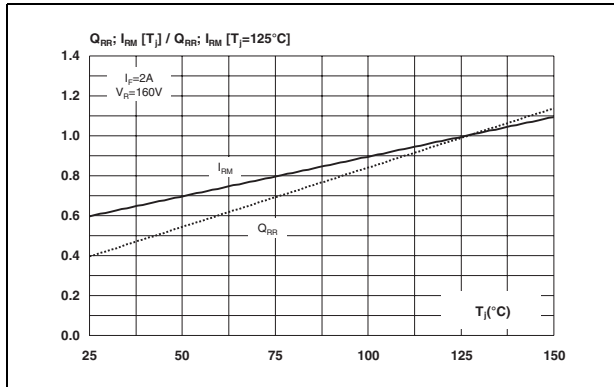

Figure 12. Thermal resistance, junction to ambient, versus copper surface under each lead - SMA/SMB (epoxy FR4, e_{cu} = 35 μm)

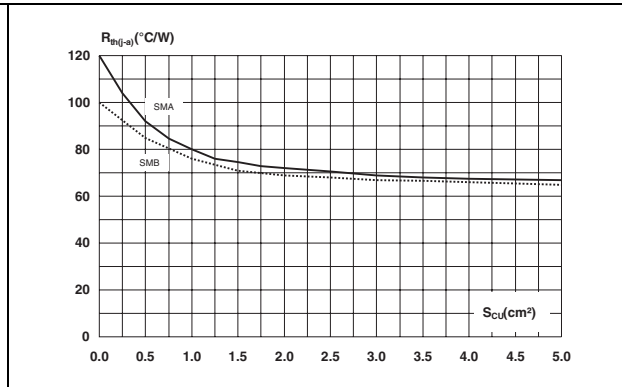
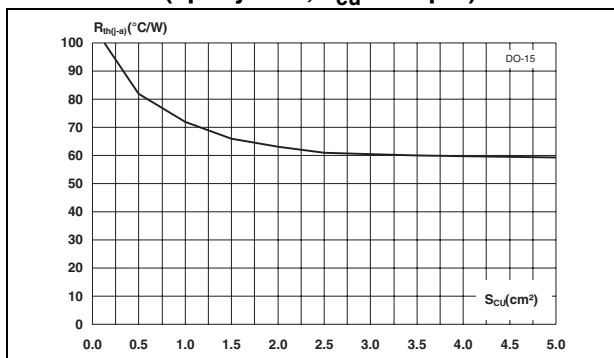
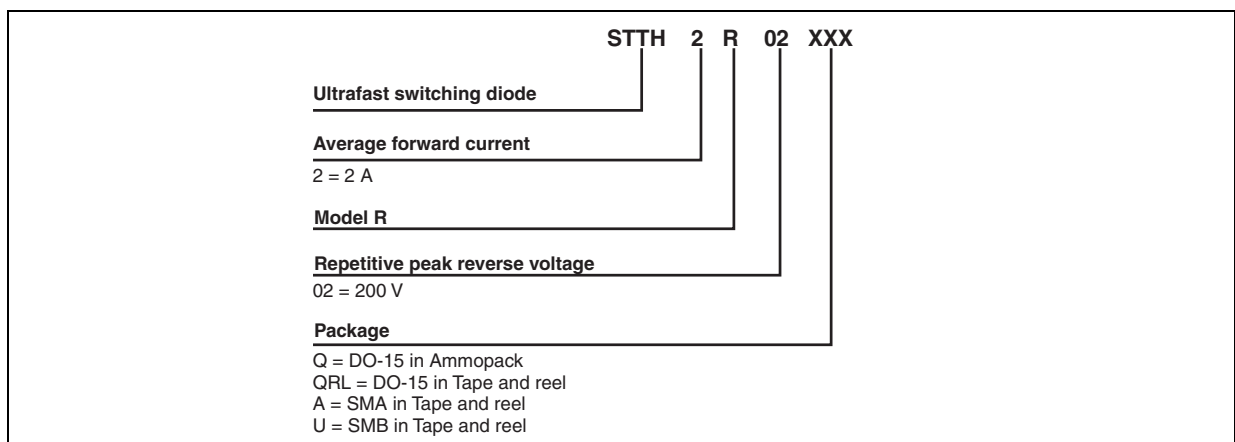

Figure 13. Thermal resistance, junction to ambient, versus copper surface under each lead DO-15 (epoxy FR4, e_{cu} = 35 μm)



2 Ordering information scheme



3 Package information

Epoxy meets UL94, V0

Table 5. DO-15 Dimensions

	DIMENSIONS			
	Millimeters		Inches	
	Min.	Max.	Min.	Max.
	A	6.05	6.75	0.238
B	2.95	3.53	0.116	0.139
C	26	31	1.024	1.220
D	0.71	0.88	0.028	0.035

Table 6. SMA dimensions

	DIMENSIONS				
	Millimeters		Inches		
	Min.	Max.	Min.	Max.	
	A1	1.90	2.03	0.075	0.080
	A2	0.05	0.20	0.002	0.008
	b	1.25	1.65	0.049	0.065
	c	0.15	0.41	0.006	0.016
	E	4.80	5.60	0.189	0.220
	E1	3.95	4.60	0.156	0.181
	D	2.25	2.95	0.089	0.116
L	0.75	1.60	0.030	0.063	

Figure 14. SMA footprint (dimensions in mm)

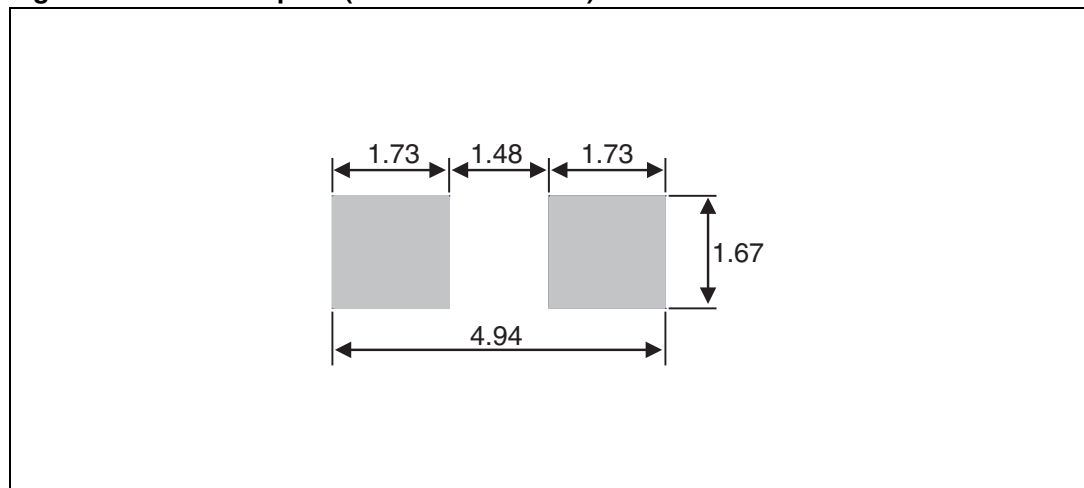
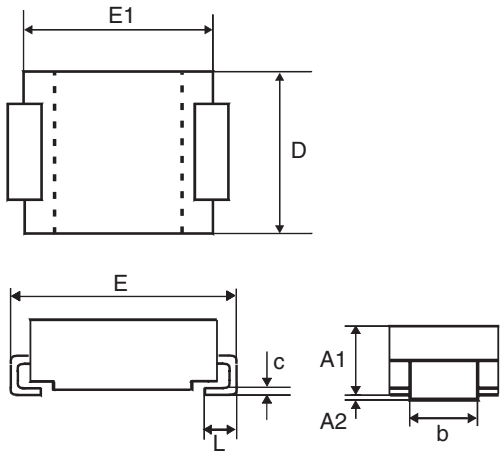
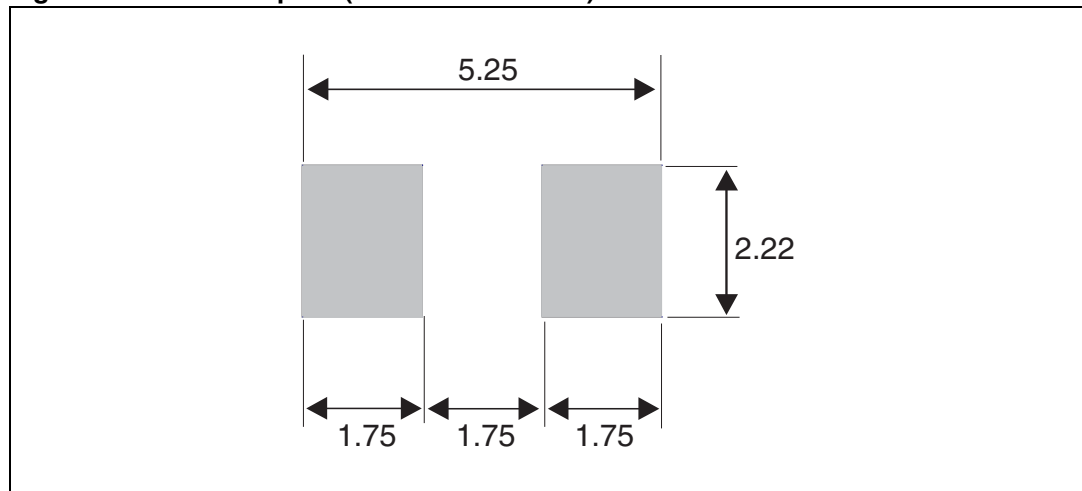

Table 7. SMB dimensions



REF.	DIMENSIONS					
	Millimeters			Inches		
	Min.		Max.	Min.		Max.
A1	1.90	2.15	2.45	0.075	0.085	0.096
A2	0.05	0.15	0.20	0.002	0.006	0.008
b	1.95		2.20	0.077		0.087
c	0.15		0.41	0.006		0.016
E	5.10	5.40	5.60	0.201	0.213	0.220
E1	4.05	4.30	4.60	0.159	0.169	0.181
D	3.30	3.60	3.95	0.130	0.142	0.156
L	0.75	1.15	1.60	0.030	0.045	0.063

Figure 15. SMB footprint (dimensions in mm)



In order to meet environmental requirements, ST offers these devices in ECOPACK® packages. These packages have a lead-free second level interconnect. The category of second level interconnect is marked on the package and on the inner box label, in compliance with JEDEC Standard JESD97. The maximum ratings related to soldering conditions are also marked on the inner box label. ECOPACK is an ST trademark. ECOPACK specifications are available at: www.st.com.

4 Ordering information

Part Number	Marking	Package	Weight	Base qty	Delivery mode
STTH2R02Q	STTH2R02	DO-15	0.4 g	1000	Ammopack
STTH2R02QRL	STTH2R02	DO-15	0.4 g	6000	Tape and reel
STTH2R02A	R2A	SMA	0.068 g	5000	Tape and reel
STTH2R02U	R2U	SMB	0.12 g	2500	Tape and reel

5 Revision history

Date	Revision	Description of Changes
03-May-2006	1	First issue
13-Oct-2006	2	Maximum T_j set to 175° C for all packages in Table 1.

Please Read Carefully:

Information in this document is provided solely in connection with ST products. STMicroelectronics NV and its subsidiaries ("ST") reserve the right to make changes, corrections, modifications or improvements, to this document, and the products and services described herein at any time, without notice.

All ST products are sold pursuant to ST's terms and conditions of sale.

Purchasers are solely responsible for the choice, selection and use of the ST products and services described herein, and ST assumes no liability whatsoever relating to the choice, selection or use of the ST products and services described herein.

No license, express or implied, by estoppel or otherwise, to any intellectual property rights is granted under this document. If any part of this document refers to any third party products or services it shall not be deemed a license grant by ST for the use of such third party products or services, or any intellectual property contained therein or considered as a warranty covering the use in any manner whatsoever of such third party products or services or any intellectual property contained therein.

UNLESS OTHERWISE SET FORTH IN ST'S TERMS AND CONDITIONS OF SALE ST DISCLAIMS ANY EXPRESS OR IMPLIED WARRANTY WITH RESPECT TO THE USE AND/OR SALE OF ST PRODUCTS INCLUDING WITHOUT LIMITATION IMPLIED WARRANTIES OF MERCHANTABILITY, FITNESS FOR A PARTICULAR PURPOSE (AND THEIR EQUIVALENTS UNDER THE LAWS OF ANY JURISDICTION), OR INFRINGEMENT OF ANY PATENT, COPYRIGHT OR OTHER INTELLECTUAL PROPERTY RIGHT.

UNLESS EXPRESSLY APPROVED IN WRITING BY AN AUTHORIZED ST REPRESENTATIVE, ST PRODUCTS ARE NOT RECOMMENDED, AUTHORIZED OR WARRANTED FOR USE IN MILITARY, AIR CRAFT, SPACE, LIFE SAVING, OR LIFE SUSTAINING APPLICATIONS, NOR IN PRODUCTS OR SYSTEMS WHERE FAILURE OR MALFUNCTION MAY RESULT IN PERSONAL INJURY, DEATH, OR SEVERE PROPERTY OR ENVIRONMENTAL DAMAGE. ST PRODUCTS WHICH ARE NOT SPECIFIED AS "AUTOMOTIVE GRADE" MAY ONLY BE USED IN AUTOMOTIVE APPLICATIONS AT USER'S OWN RISK.

Resale of ST products with provisions different from the statements and/or technical features set forth in this document shall immediately void any warranty granted by ST for the ST product or service described herein and shall not create or extend in any manner whatsoever, any liability of ST.

ST and the ST logo are trademarks or registered trademarks of ST in various countries.

Information in this document supersedes and replaces all information previously supplied.

The ST logo is a registered trademark of STMicroelectronics. All other names are the property of their respective owners.

© 2006 STMicroelectronics - All rights reserved

STMicroelectronics group of companies

Australia - Belgium - Brazil - Canada - China - Czech Republic - Finland - France - Germany - Hong Kong - India - Israel - Italy - Japan - Malaysia - Malta - Morocco - Singapore - Spain - Sweden - Switzerland - United Kingdom - United States of America

www.st.com