

# THS3001 420-MHz HIGH-SPEED CURRENT-FEEDBACK AMPLIFIER

SLOS217 – JULY 1998

- **High Speed**
  - 420 MHz Bandwidth ( $G = 1$ ,  $-3$  dB)
  - 6500 V/ $\mu$ s Slew Rate
  - 40-ns Settling Time (0.1%)
- **High Output Drive,  $I_O = 100$  mA**
- **Excellent Video Performance**
  - 115 MHz Bandwidth (0.1 dB,  $G = 2$ )
  - 0.01% Differential Gain
  - 0.02° Differential Phase
- **Low 3-mV (max) Input Offset Voltage**
- **Very Low Distortion**
  - THD =  $-96$  dBc at  $f = 1$  MHz
  - THD =  $-80$  dBc at  $f = 10$  MHz
- **Wide Range of Power Supplies**
  - $V_{CC} = \pm 4.5$  V to  $\pm 16$  V

## applications

- Scanning and Imaging Systems
- IF and RF Amplification
- ADC/DAC Buffers
- High-Definition TV
- Pulse Amplifier
- Video Amplifier

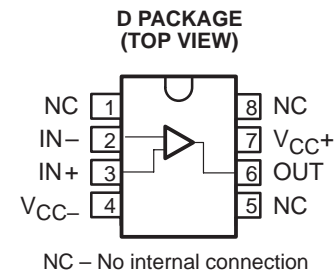

## description

The THS3001 is a high-speed current feedback operational amplifier ideal for communication, imaging, and high-quality video applications. It offers a very fast 6500-V/ $\mu$ s slew rate, 420-MHz bandwidth, and 40-ns settling time for large-signal applications requiring excellent transient response. In addition, the THS3001 maintains a 0.1-dB gain flatness to a bandwidth of 115-MHz. The combination of gain flatness, low 0.01% differential gain and 0.02° differential phase make this device a superb choice for video systems. The THS3001 operates with a very low distortion of  $-96$  dBc making it well suited for applications such as wireless communication basestations or ultra-fast ADC or DAC buffers. The THS3001 is specified to operate over a wide range of power supply voltages from  $\pm 4.5$  V to  $\pm 16$  V.

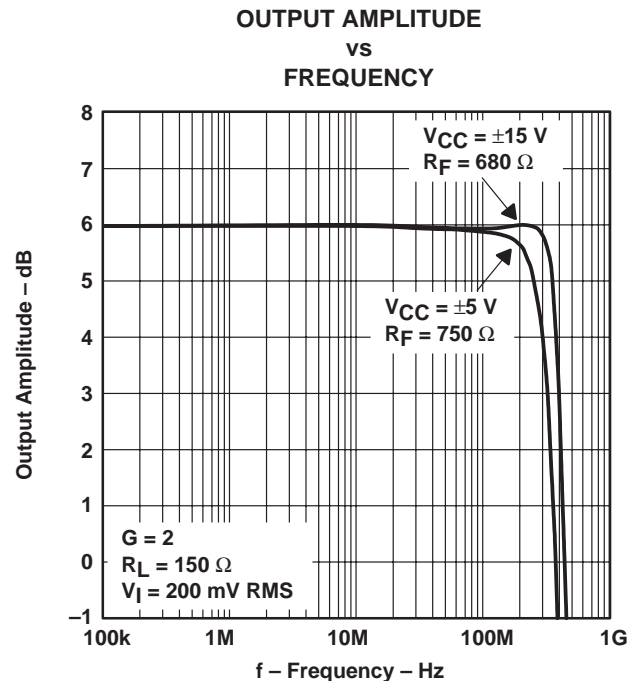

**CAUTION:** The THS3001 provides ESD protection circuitry. However, permanent damage can still occur if this device is subjected to high-energy electrostatic discharges. Proper ESD precautions are recommended to avoid any performance degradation or loss of functionality.



Please be aware that an important notice concerning availability, standard warranty, and use in critical applications of Texas Instruments semiconductor products and disclaimers thereto appears at the end of this data sheet.

PRODUCTION DATA information is current as of publication date. Products conform to specifications per the terms of Texas Instruments standard warranty. Production processing does not necessarily include testing of all parameters.

 **TEXAS  
INSTRUMENTS**

POST OFFICE BOX 655303 • DALLAS, TEXAS 75265

Copyright © 1998, Texas Instruments Incorporated

# THS3001 420-MHz HIGH-SPEED CURRENT-FEEDBACK AMPLIFIER

SLOS217 – JULY 1998

### AVAILABLE OPTIONS

T <sub>A</sub>	PACKAGED DEVICE
	SOIC† (D)
0°C to 70°C	THS3001CD
-40°C to 85°C	THS3001ID

† The D package is available taped and reeled. Add an R suffix to the device type (i.e., THS3001CDR)

### simplified schematic

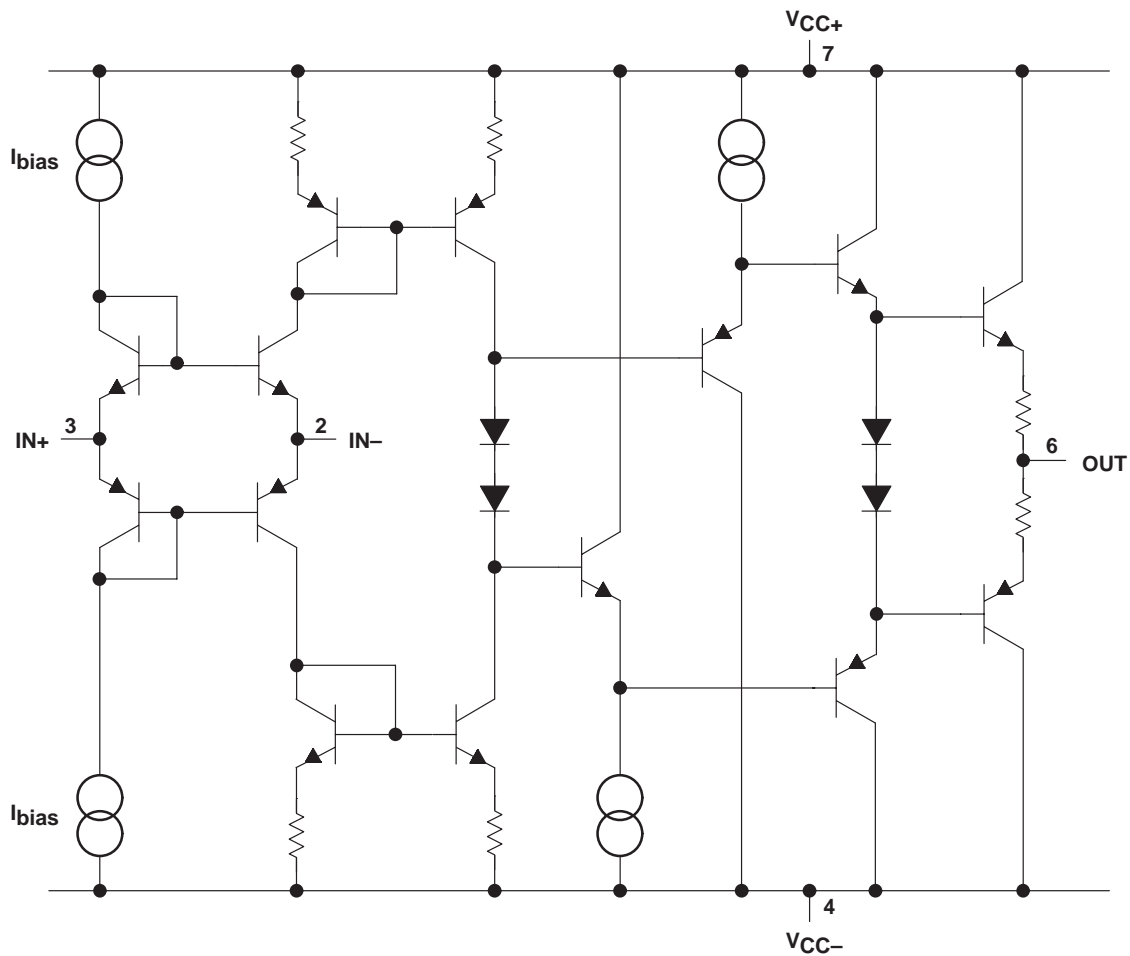

# THS3001

## 420-MHz HIGH-SPEED CURRENT-FEEDBACK AMPLIFIER

SLOS217 – JULY 1998

### absolute maximum ratings over operating free-air temperature range (unless otherwise noted)†

Supply voltage, $V_{CC+}$ to $V_{CC-}$ .....	33 V
Input voltage, $V_I$ .....	$\pm V_{CC}$
Output Current, $I_O$ .....	175 mA
Differential input voltage, $V_{ID}$ .....	$\pm 6$ V
Continuous total power dissipation .....	See Dissipation Rating Table
Operating free-air temperature, $T_A$ , THS3001C .....	0°C to 70°C
THS3001I .....	–40°C to 85°C
Storage temperature, $T_{stg}$ .....	–65°C to 125°C
Lead temperature, 1,6 mm (1/16 inch) from case for 10 seconds .....	300°C

† Stresses beyond those listed under “absolute maximum ratings” may cause permanent damage to the device. These are stress ratings only, and functional operation of the device at these or any other conditions beyond those indicated under “recommended operating conditions” is not implied. Exposure to absolute-maximum-rated conditions for extended periods may affect device reliability.

**DISSIPATION RATING TABLE**

PACKAGE	$T_A \leq 25^\circ\text{C}$ POWER RATING	DERATING FACTOR ABOVE $T_A = 25^\circ\text{C}$	$T_A = 70^\circ\text{C}$ POWER RATING	$T_A = 85^\circ\text{C}$ POWER RATING
D	740 mW	6 mW/°C	470 mW	380 mW

### recommended operating conditions

		MIN	NOM	MAX	UNIT
Supply voltage, $V_{CC+}$ and $V_{CC-}$	Split supply	$\pm 4.5$		$\pm 16$	V
	Single supply	9		32	
Operating free-air temperature, $T_A$	THS3001C	0		70	°C
	THS3001I	–40		85	



# THS3001

## 420-MHz HIGH-SPEED CURRENT-FEEDBACK AMPLIFIER

SLOS217 – JULY 1998

### electrical characteristics, $T_A = 25^\circ\text{C}$ , $R_L = 150\ \Omega$ , $R_F = 1\ \text{k}\Omega$ (unless otherwise noted)

PARAMETER		TEST CONDITION <sup>†</sup>		MIN	TYP	MAX	UNIT		
V <sub>CC</sub>	Power supply operating range	Split supply		±4.5		±16.5	V		
		Single supply		9		33			
I <sub>CC</sub>	Quiescent current	V <sub>CC</sub> = ±5 V	T <sub>A</sub> = 25°C		5.5	7.5	mA		
			T <sub>A</sub> = full range			8.5			
		V <sub>CC</sub> = ±15 V	T <sub>A</sub> = 25°C		6.6	9			
			T <sub>A</sub> = full range			10			
V <sub>O</sub>	Output voltage swing	V <sub>CC</sub> = ±5 V	R <sub>L</sub> = 150 Ω	±2.9	±3.2	V			
			R <sub>L</sub> = 1 kΩ	±3	±3.3				
		V <sub>CC</sub> = ±15 V	R <sub>L</sub> = 150 Ω	±12.1	±12.8				
			R <sub>L</sub> = 1 kΩ	±12.8	±13.1				
I <sub>O</sub>	Output current (see Note 1)	V <sub>CC</sub> = ±5 V, R <sub>L</sub> = 20 Ω		100	mA				
		V <sub>CC</sub> = ±15 V, R <sub>L</sub> = 75 Ω	85	120					
V <sub>IO</sub>	Input offset voltage	V <sub>CC</sub> = ±5 V or ±15 V	T <sub>A</sub> = 25°C		1	3	mV		
			T <sub>A</sub> = full range			4			
Input offset voltage drift		V <sub>CC</sub> = ±5 V or ±15 V			5		μV/°C		
I <sub>IB</sub>	Input bias current	-Input	V <sub>CC</sub> = ±5 V or ±15 V	T <sub>A</sub> = 25°C		2	10	μA	
				T <sub>A</sub> = full range			15		
				+Input	T <sub>A</sub> = 25°C		1		10
					T <sub>A</sub> = full range				15
V <sub>ICR</sub>	Common-mode input voltage range	V <sub>CC</sub> = ±5 V		±3	±3.2	V			
		V <sub>CC</sub> = ±15 V		±12.9	±13.2				
	Open loop transresistance	V <sub>CC</sub> = ±5 V, R <sub>L</sub> = 1 kΩ	V <sub>O</sub> = ±2.5 V,		1.3	MΩ			
		V <sub>CC</sub> = ±15 V, R <sub>L</sub> = 1 kΩ	V <sub>O</sub> = ±7.5 V,		2.4				
CMRR	Common-mode rejection ratio	V <sub>CC</sub> = ±5 V, V <sub>CM</sub> = ±2.5 V		62	70	dB			
		V <sub>CC</sub> = ±15 V, V <sub>CM</sub> = ±10 V		65	73				
PSRR	Power supply rejection ratio	V <sub>CC</sub> = ±5 V	T <sub>A</sub> = 25°C		65	76	dB		
			T <sub>A</sub> = full range		63				
		V <sub>CC</sub> = ±15 V	T <sub>A</sub> = 25°C		69	76	dB		
			T <sub>A</sub> = full range		67				
R <sub>I</sub>	Input resistance	+Input			1.5	MΩ			
		-Input			15	Ω			
C <sub>I</sub>	Differential input capacitance				7.5	pF			
R <sub>O</sub>	Output resistance	Open loop at 5 MHz			10	Ω			
V <sub>n</sub>	Input voltage noise	V <sub>CC</sub> = ±5 V or ±15 V, f = 10 kHz, G = 2			1.6	nV/√Hz			
I <sub>n</sub>	Input current noise	Positive (IN+)	V <sub>CC</sub> = ±5 V or ±15 V, f = 10 kHz, G = 2		13	pA/√Hz			
		Negative (IN-)			16				

<sup>†</sup> Full range = 0°C to 70°C for the THS3001C and -40°C to 85°C for the THS3001I.

NOTE 1: Observe power dissipation ratings to keep the junction temperature below absolute maximum when the output is heavily loaded or shorted. See absolute maximum ratings section.



# THS3001 420-MHz HIGH-SPEED CURRENT-FEEDBACK AMPLIFIER

SLOS217 – JULY 1998

operating characteristics,  $T_A = 25^\circ\text{C}$ ,  $R_L = 150\ \Omega$ ,  $R_F = 1\ \text{k}\Omega$  (unless otherwise noted)

PARAMETER		TEST CONDITIONS		MIN	TYP	MAX	UNIT
SR	Slew rate (see Note 2)	$V_{CC} = \pm 5\ \text{V}$ , $V_{O(PP)} = 4\ \text{V}$	$G = -5$		1700		V/ $\mu\text{s}$
			$G = 5$		1300		
		$V_{CC} = \pm 15\ \text{V}$ , $V_{O(PP)} = 20\ \text{V}$	$G = -5$		6500		
			$G = 5$		6300		
$t_s$	Settling time to 0.1%	$V_{CC} = \pm 15\ \text{V}$ , 0 V to 10 V Step	Gain = -1,		40		ns
	Settling time to 0.1%	$V_{CC} = \pm 5\ \text{V}$ , 0 V to 2 V Step,	Gain = -1,		25		
THD	Total harmonic distortion	$V_{CC} = \pm 15\ \text{V}$ , $f_c = 10\ \text{MHz}$ ,	$V_{O(PP)} = 2\ \text{V}$ , $G = 2$		-80		dBc
$A_D$	Differential gain error	$G = 2$ , 40 IRE modulation, $\pm 100$ IRE Ramp, NTSC and PAL	$V_{CC} = \pm 5\ \text{V}$		0.015%		
			$V_{CC} = \pm 15\ \text{V}$		0.01%		
$\theta_D$	Differential phase error	$G = 2$ , 40 IRE modulation, $\pm 100$ IRE Ramp, NTSC and PAL	$V_{CC} = \pm 5\ \text{V}$		$0.01^\circ$		
			$V_{CC} = \pm 15\ \text{V}$		$0.02^\circ$		
BW	Small signal bandwidth (-3 dB)	$G = 1$ , $R_F = 1\ \text{k}\Omega$ ,	$V_{CC} = \pm 5\ \text{V}$ ,		330		MHz
			$V_{CC} = \pm 15\ \text{V}$ ,		420		MHz
		$G = 2$ , $R_F = 750\ \Omega$ ,	$V_{CC} = \pm 5\ \text{V}$		300		MHz
		$G = 2$ , $R_F = 680\ \Omega$ ,	$V_{CC} = \pm 15\ \text{V}$		385		
	Bandwidth for 0.1 dB flatness	$G = 2$ , $R_F = 750\ \Omega$ ,	$V_{CC} = \pm 5\ \text{V}$		85		MHz
		$G = 2$ , $R_F = 680\ \Omega$ ,	$V_{CC} = \pm 15\ \text{V}$		115		
Full power bandwidth (see Note 3)		$V_{CC} = \pm 5\ \text{V}$ , $V_{O(PP)} = 4\ \text{V}$ , $R_L = 500\ \Omega$	$G = -5$		65		MHz
			$G = 5$		62		MHz
		$V_{CC} = \pm 15\ \text{V}$ , $V_{O(PP)} = 20\ \text{V}$ , $R_L = 500\ \Omega$	$G = -5$		32		MHz
			$G = 5$		31		MHz

NOTES: 2. Slew rate is measured from an output level range of 25% to 75%.  
3. Full power bandwidth is defined as the frequency at which the output has 3% THD.

## PARAMETER MEASUREMENT INFORMATION

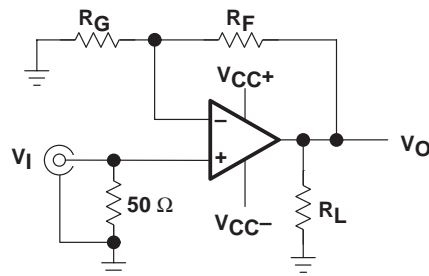

Figure 1. Test Circuit, Gain =  $1 + (R_F/R_G)$

# THS3001 420-MHz HIGH-SPEED CURRENT-FEEDBACK AMPLIFIER

SLOS217 – JULY 1998

## TYPICAL CHARACTERISTICS

Table of Graphs

			FIGURE
V <sub>O</sub>	Output voltage swing	vs Free-air temperature	2
I <sub>CC</sub>	Current supply	vs Free-air temperature	3
I <sub>IB</sub>	Input bias current	vs Free-air temperature	4
V <sub>IO</sub>	Input offset voltage	vs Free-air temperature	5
CMRR	Common-mode rejection ratio	vs Common-mode input voltage	6
		vs Common-mode input voltage	7
		vs Frequency	8
	Transresistance	vs Free-air temperature	9
	Closed-loop output impedance	vs Frequency	10
V <sub>n</sub>	Voltage noise	vs Frequency	11
I <sub>n</sub>	Current noise	vs Frequency	11
PSRR	Power supply rejection ratio	vs Frequency	12
		vs Free-air temperature	13
SR	Slew rate	vs Supply voltage	14
		vs Output step peak-to-peak	15, 16
	Normalized slew rate	vs Gain	17
	Harmonic distortion	vs Peak-to-peak output voltage swing	18, 19
		vs Frequency	20, 21
	Differential gain	vs Loading	22, 23
	Differential phase	vs Loading	24, 25
	Output amplitude	vs Frequency	26–30
	Normalized output response	vs Frequency	31–34
	Small and large signal frequency response		35, 36
	Small signal pulse response		37, 38
	Large signal pulse response		39 – 44



TYPICAL CHARACTERISTICS

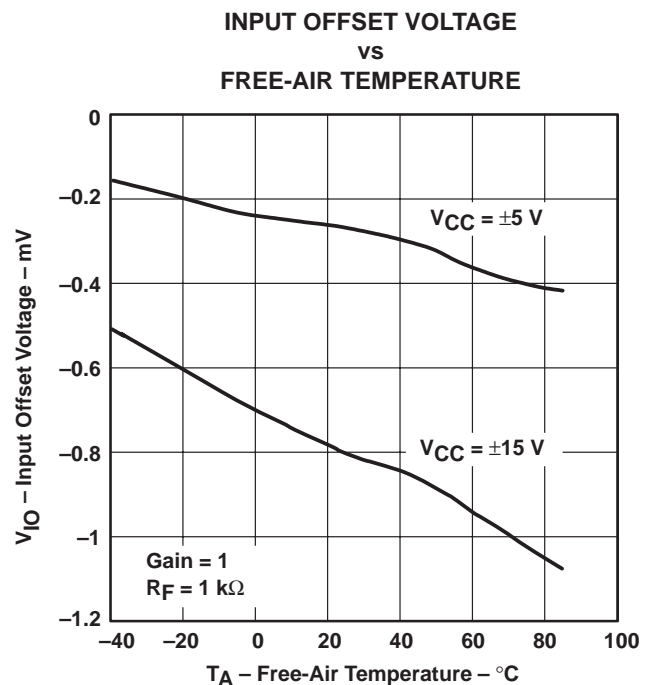
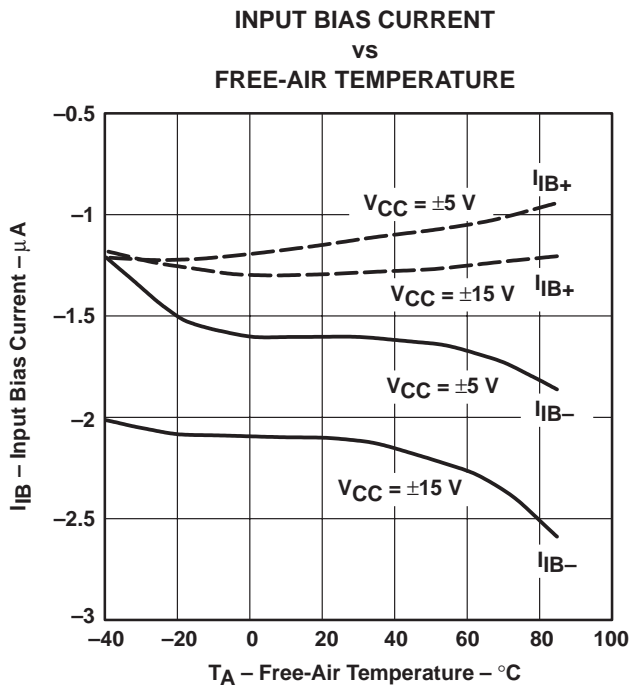
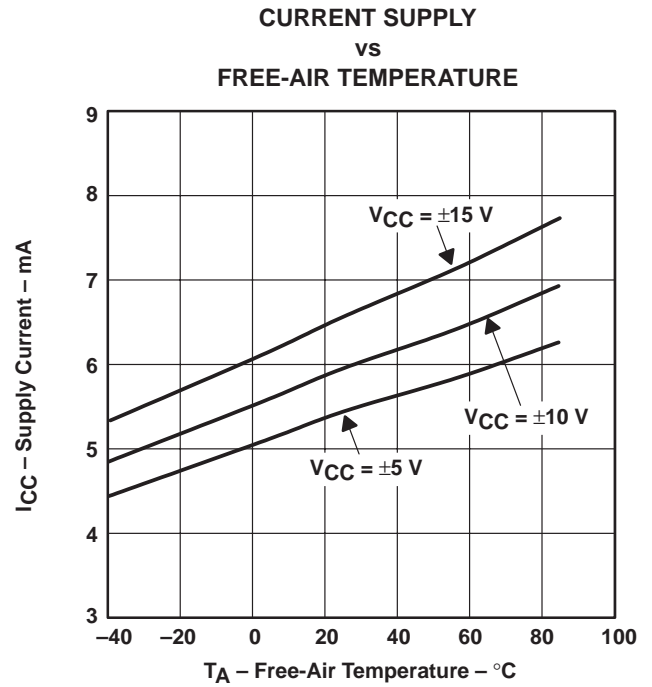
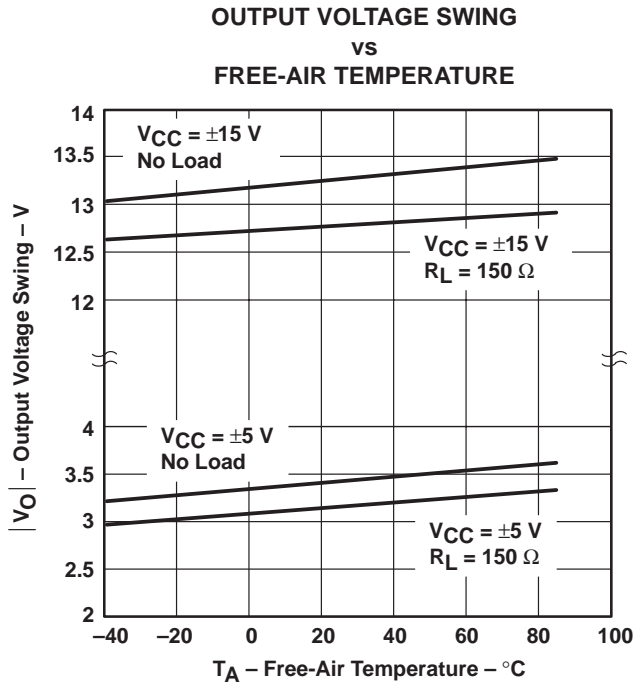

TYPICAL CHARACTERISTICS

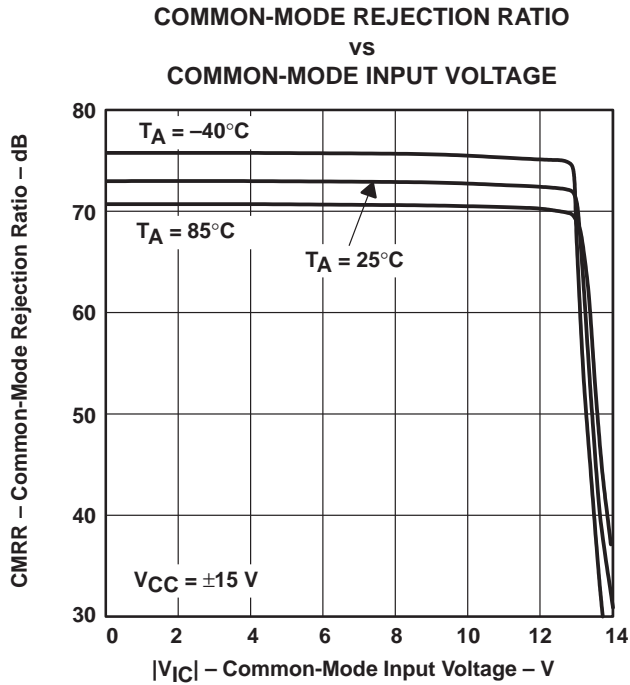

Figure 6

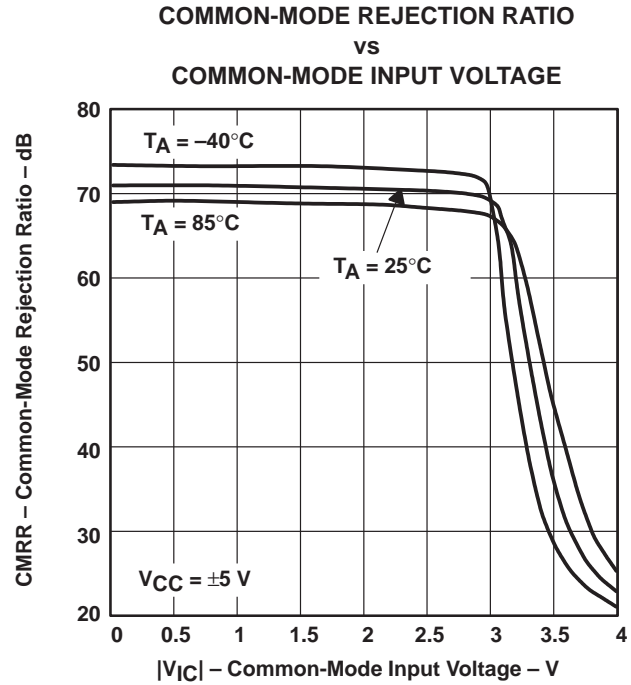

Figure 7

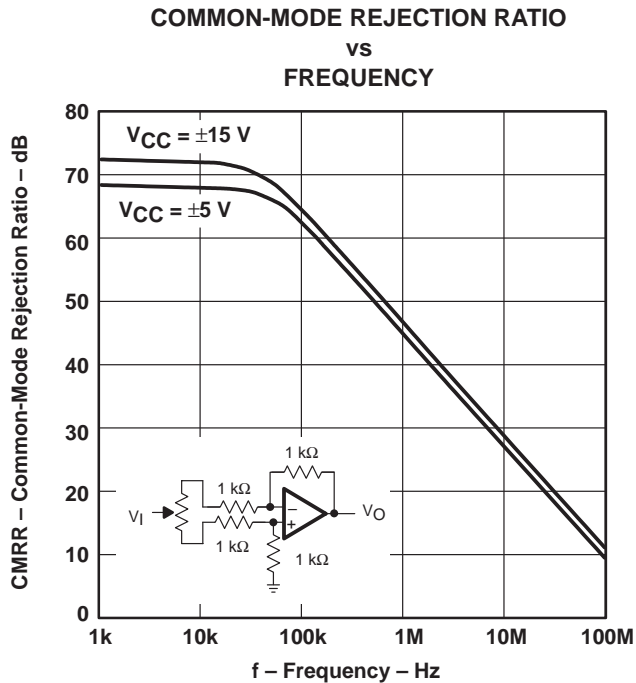

Figure 8

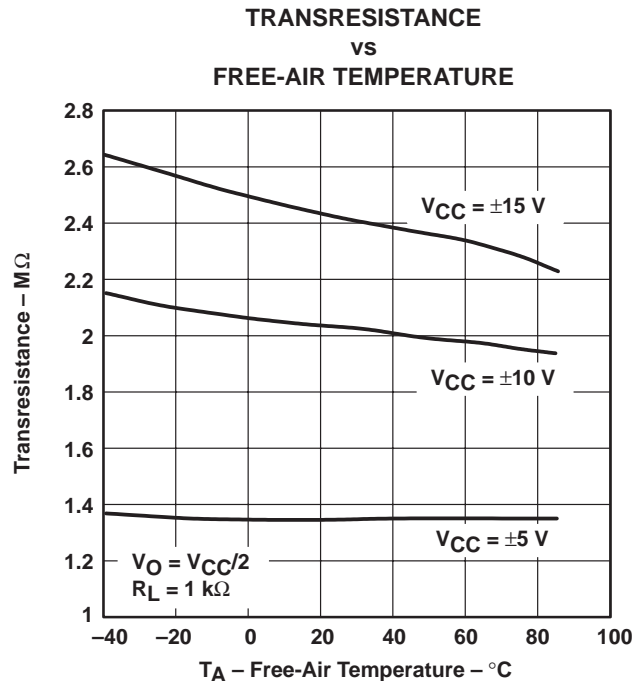
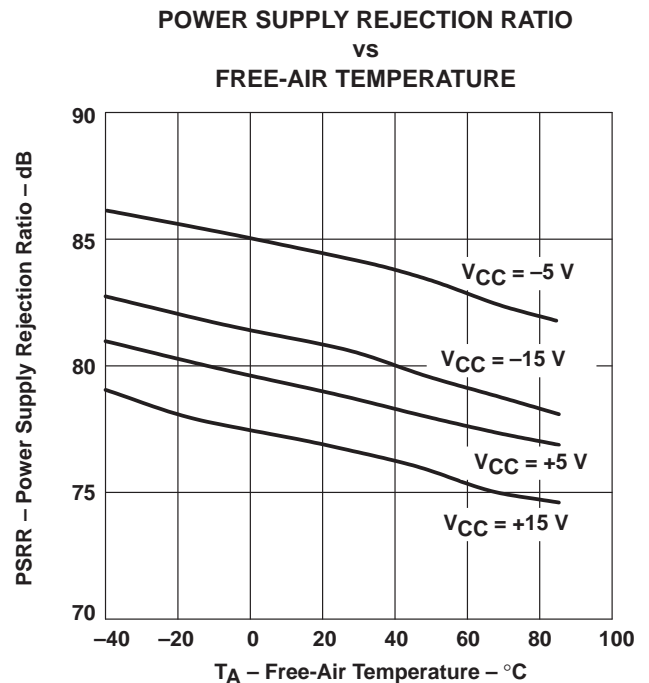
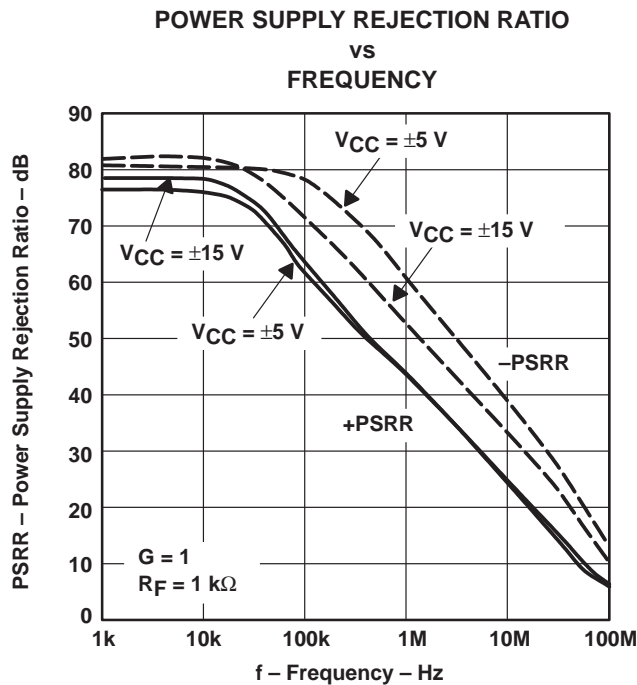
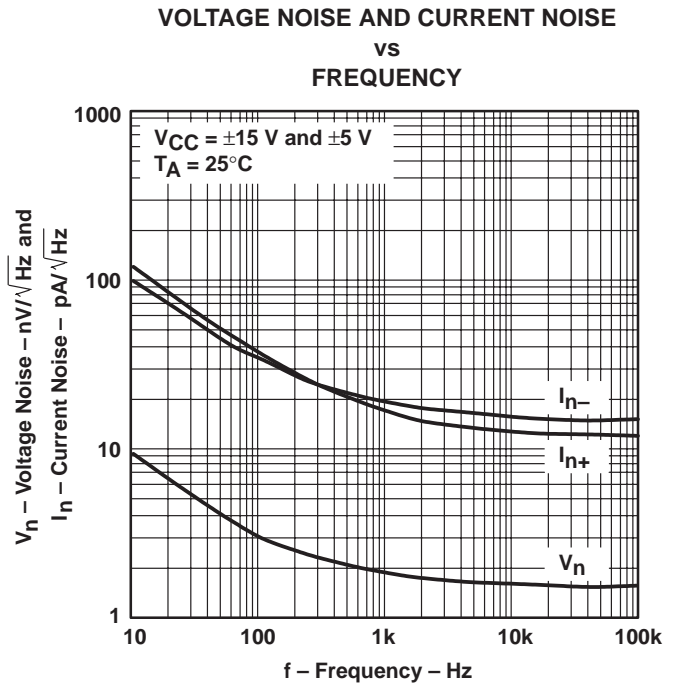
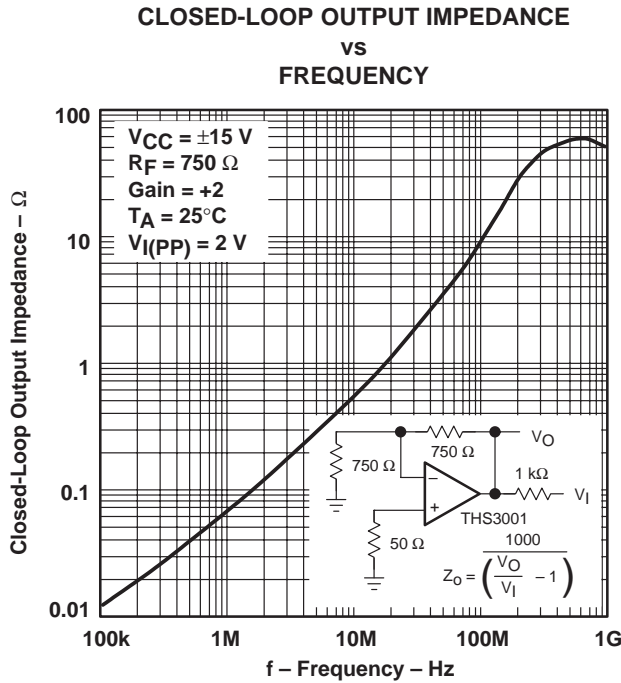

Figure 9



TYPICAL CHARACTERISTICS



**THS3001**  
**420-MHz HIGH-SPEED CURRENT-FEEDBACK AMPLIFIER**

SLOS217 – JULY 1998

**TYPICAL CHARACTERISTICS**

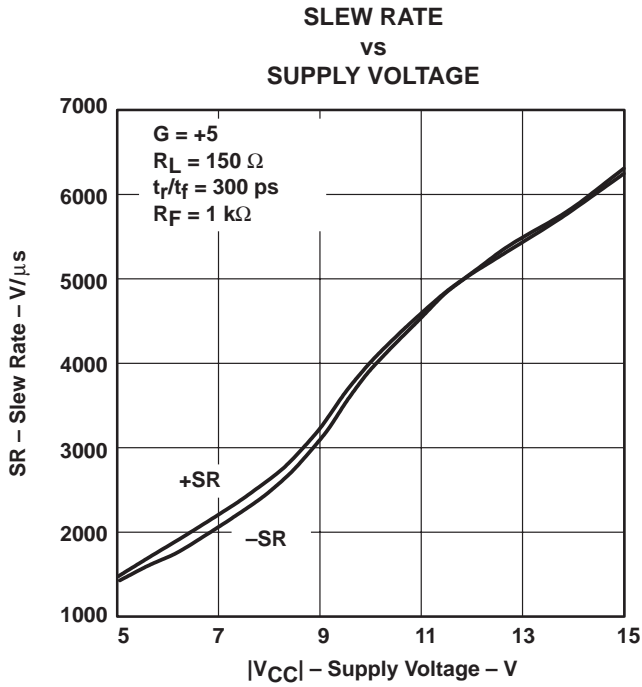

Figure 14

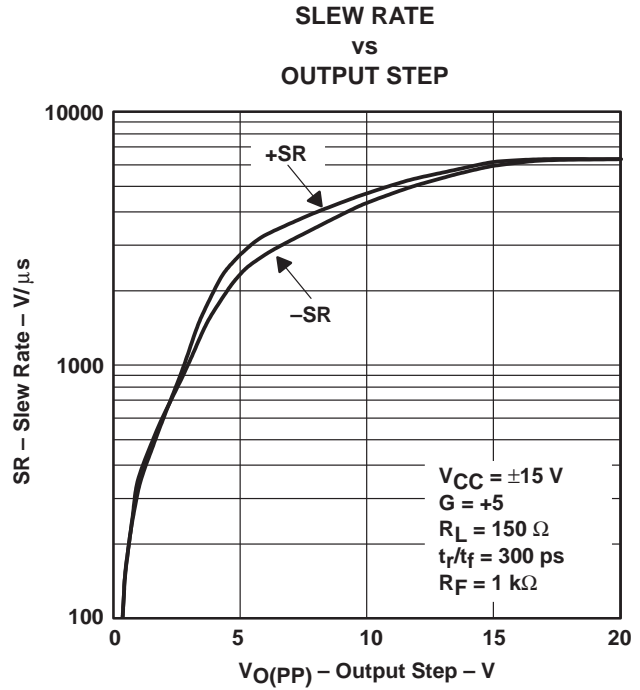

Figure 15

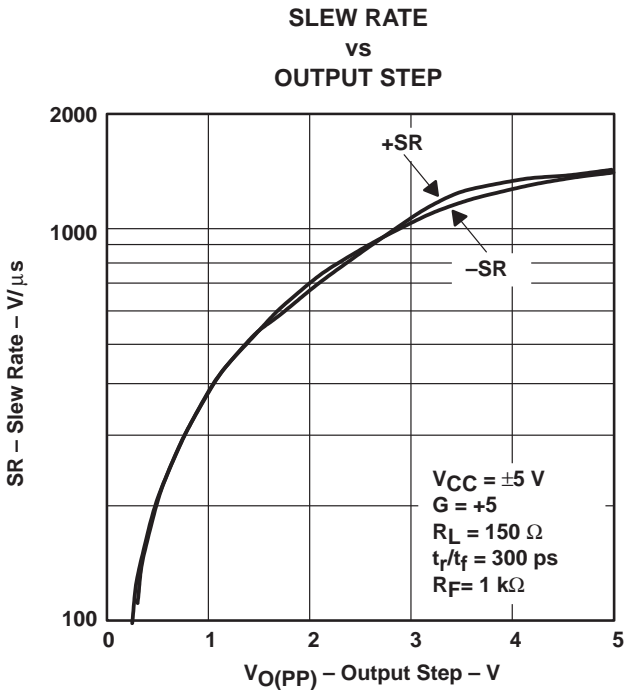

Figure 16

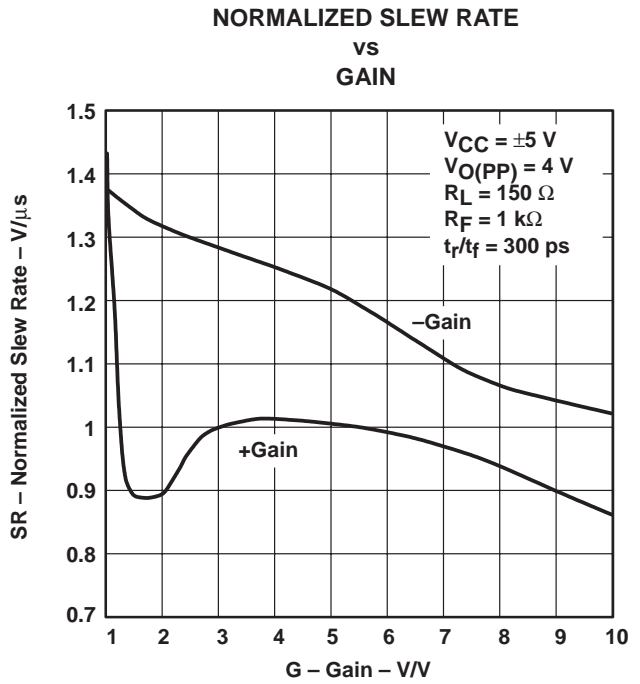
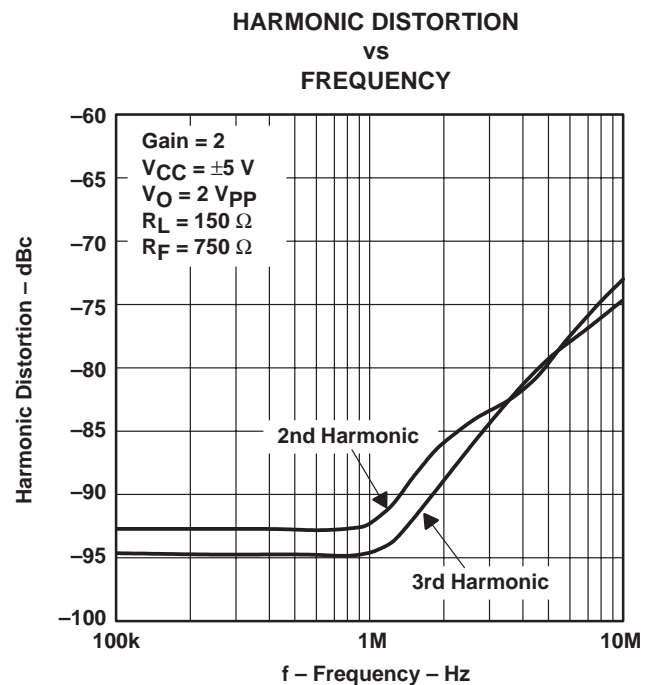
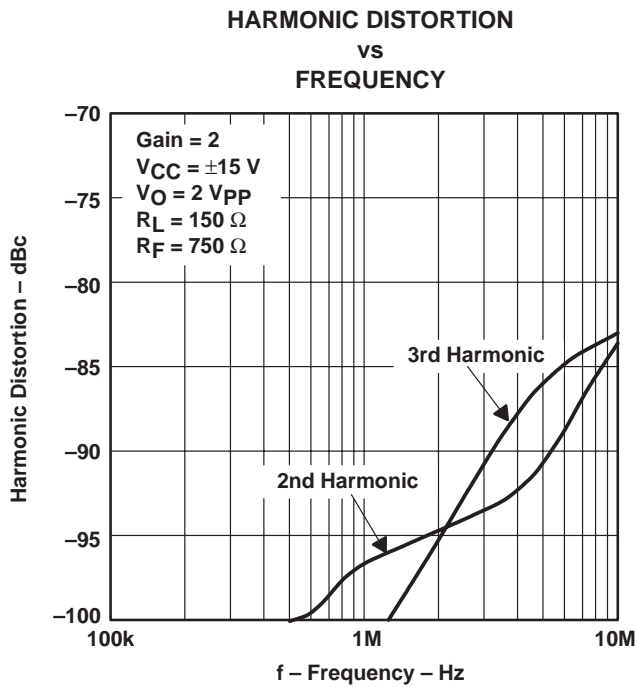
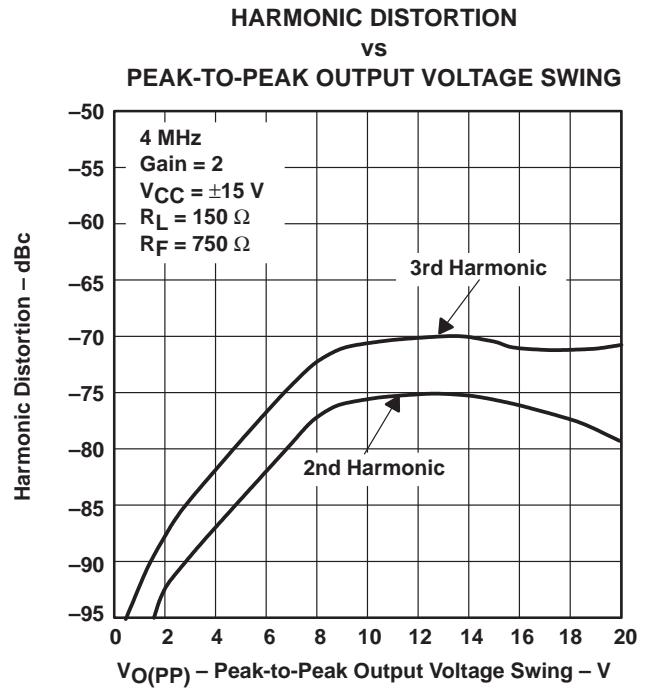
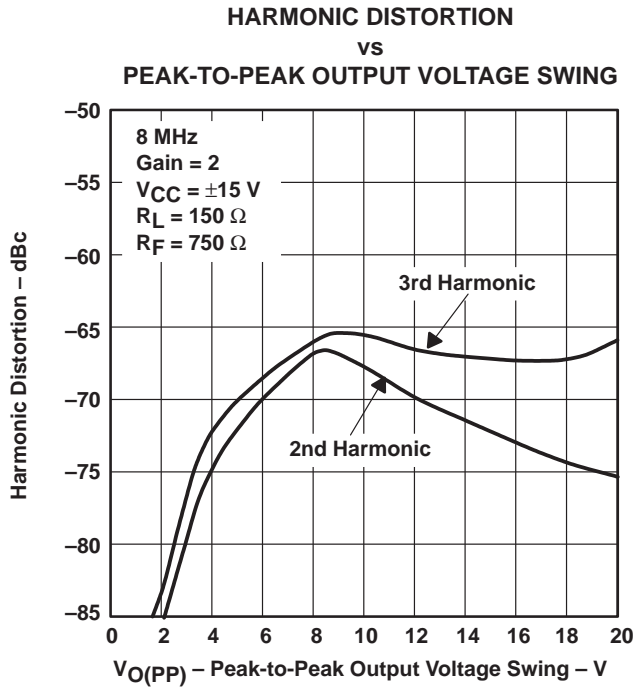

Figure 17



TYPICAL CHARACTERISTICS



TYPICAL CHARACTERISTICS

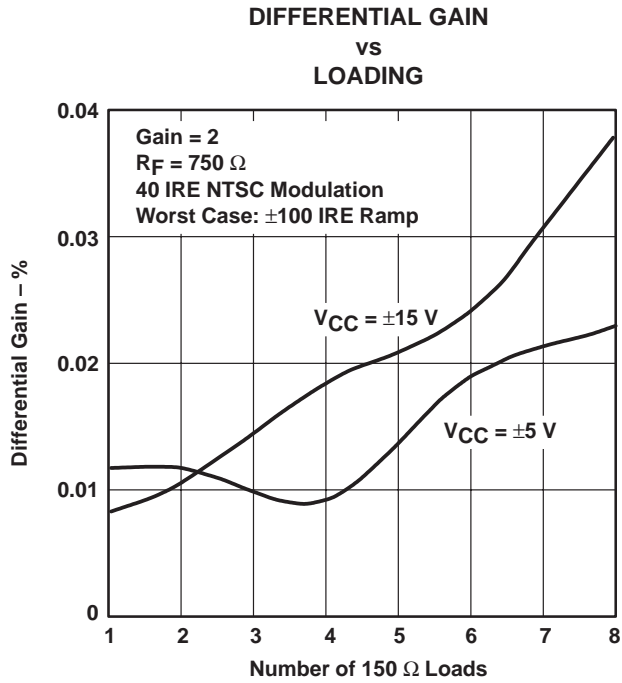

Figure 22

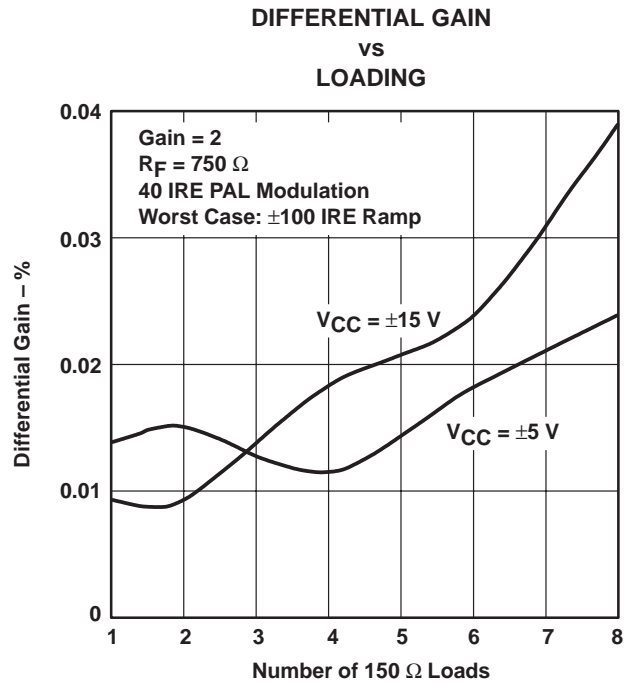

Figure 23

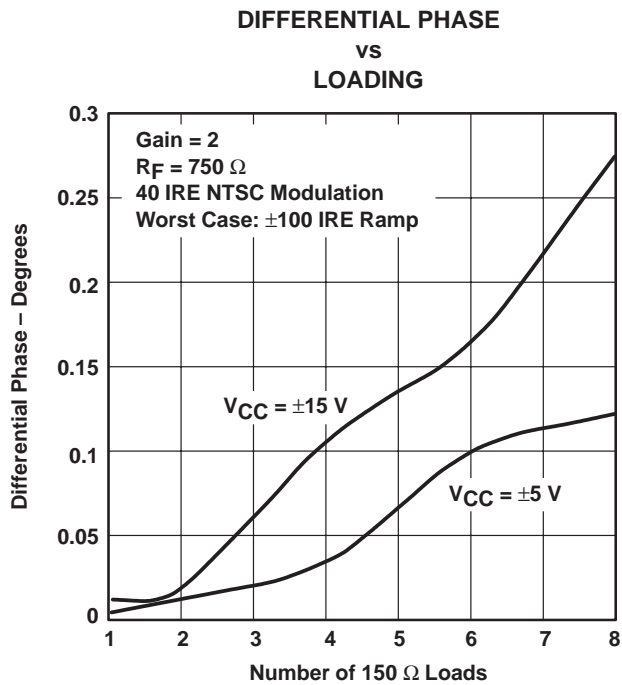

Figure 24

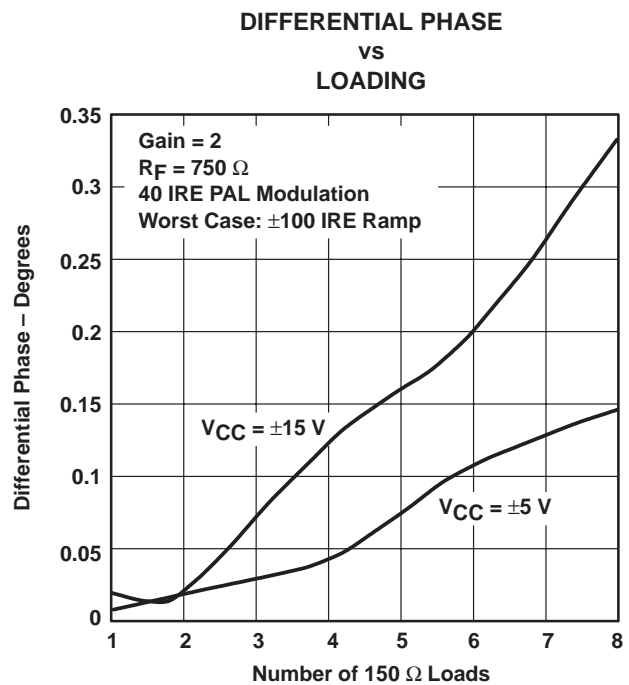

Figure 25

TYPICAL CHARACTERISTICS

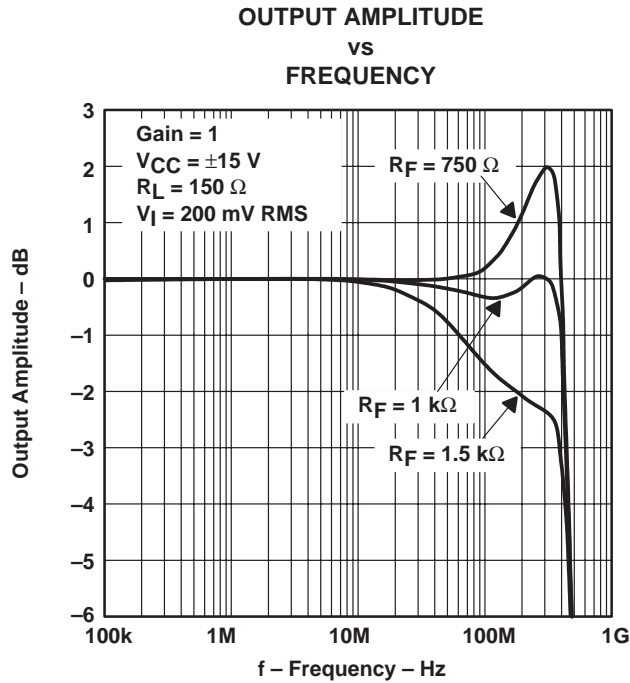

Figure 26

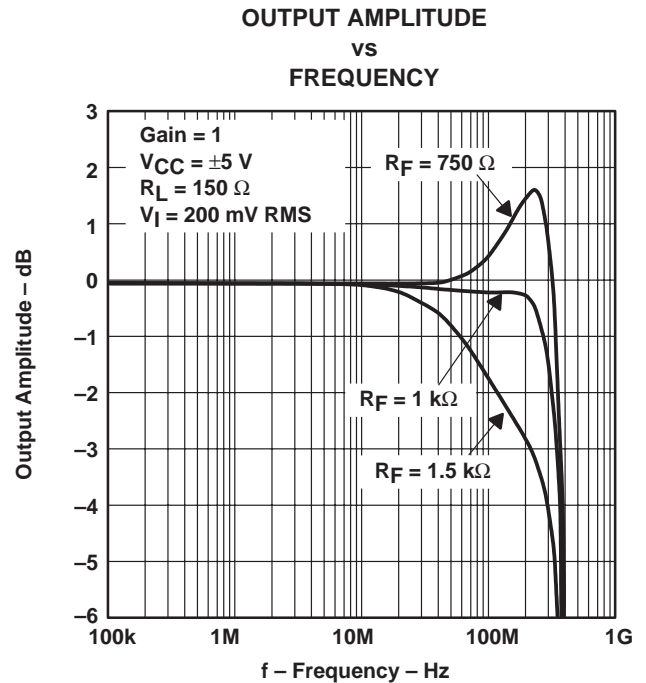

Figure 27

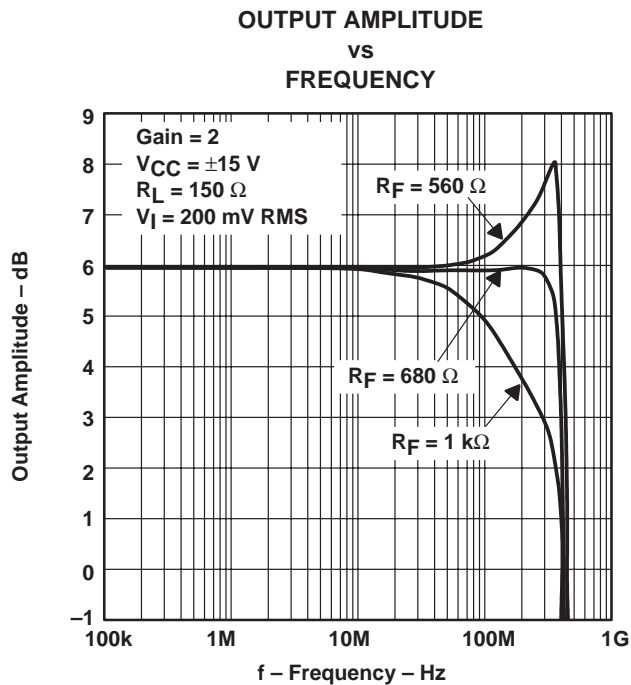

Figure 28

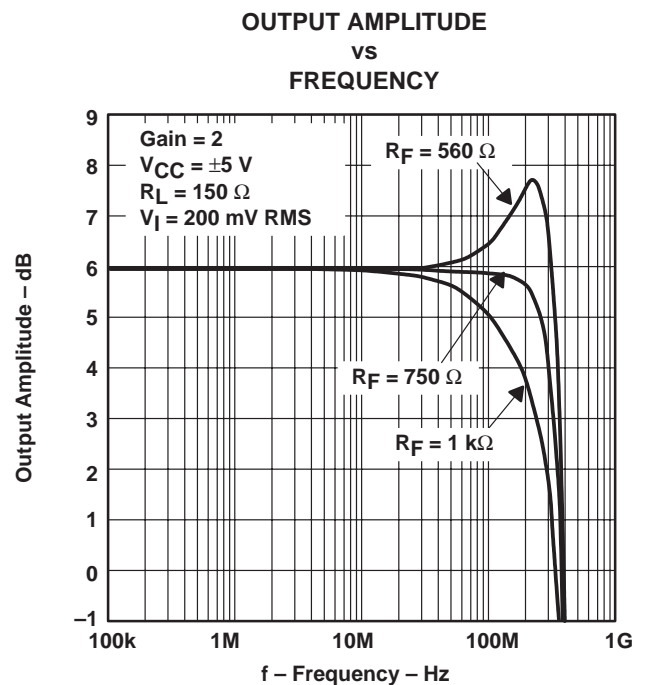
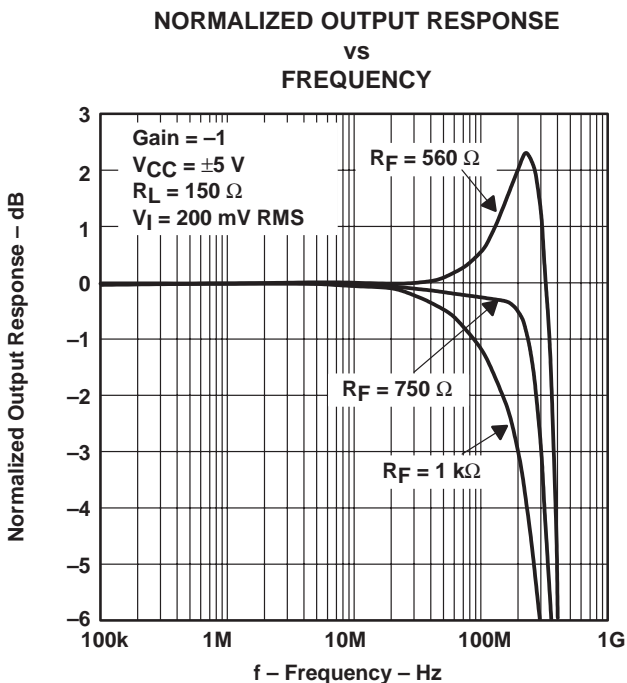
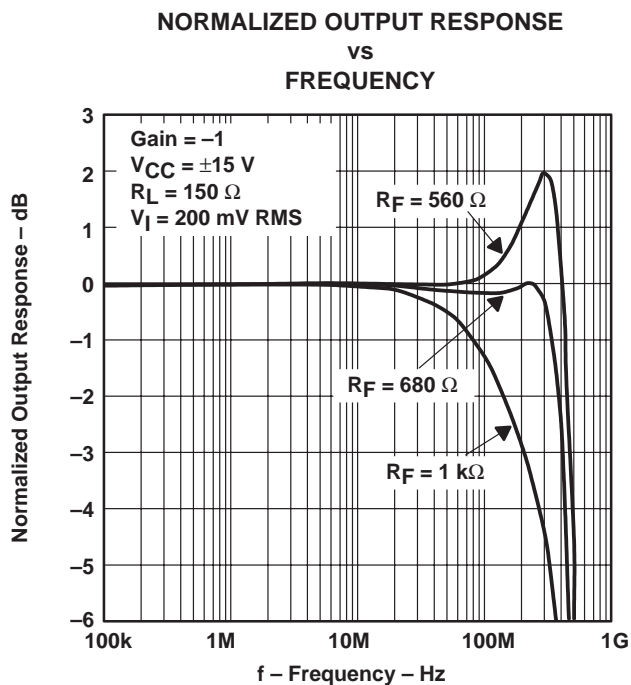
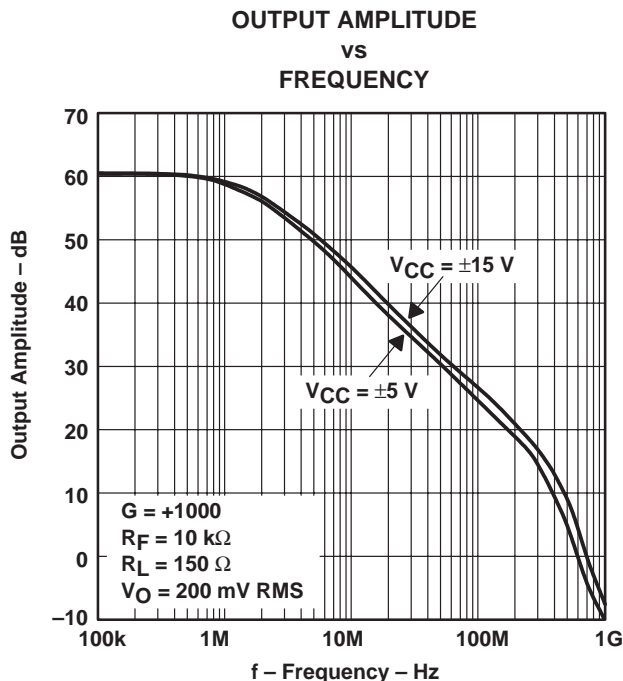

Figure 29

TYPICAL CHARACTERISTICS



TYPICAL CHARACTERISTICS

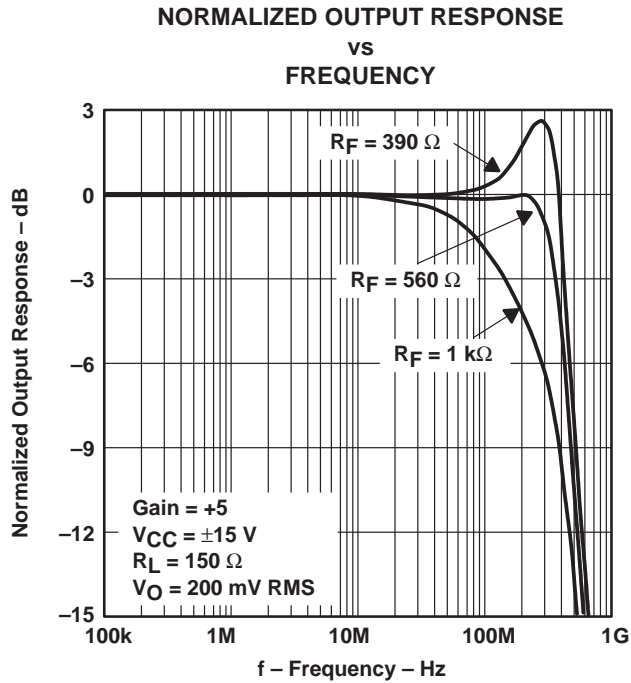

Figure 33

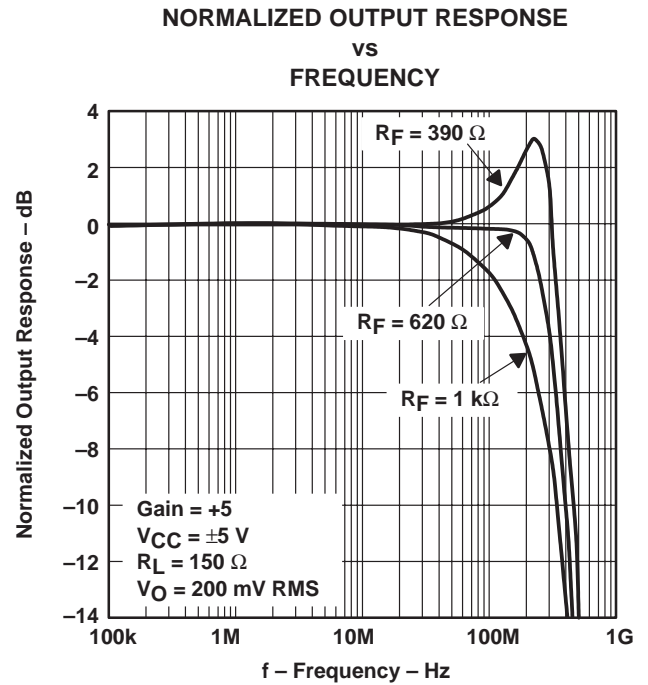

Figure 34

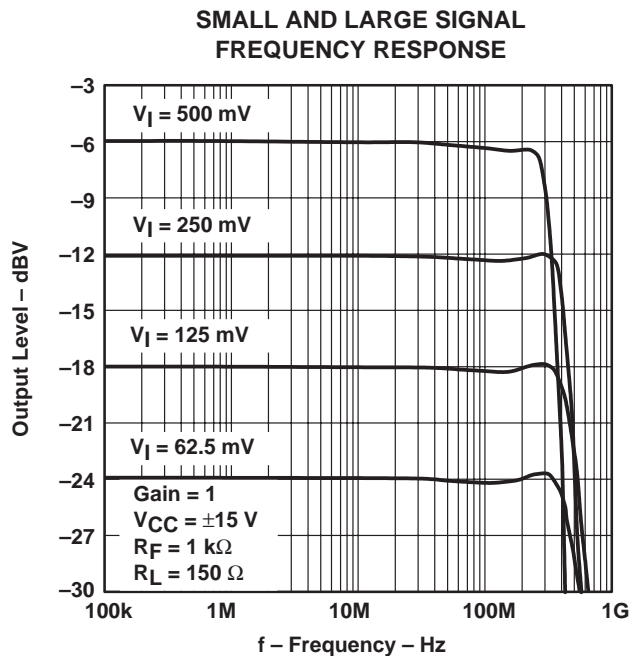

Figure 35

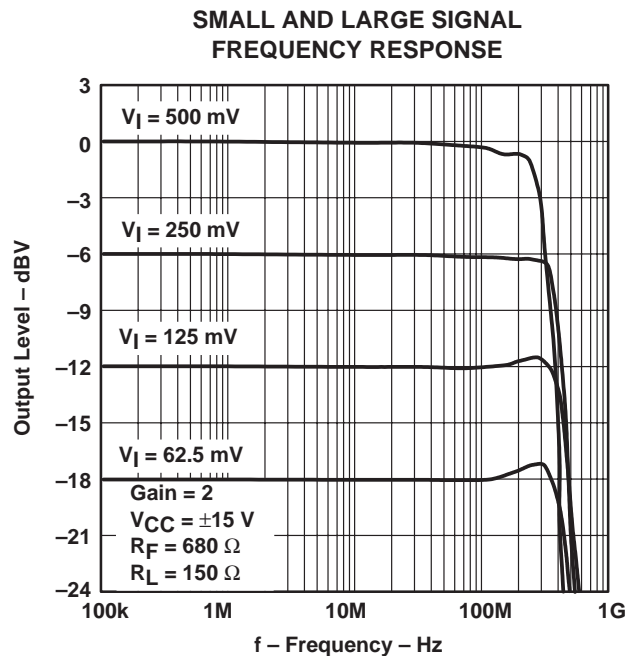

Figure 36

TYPICAL CHARACTERISTICS

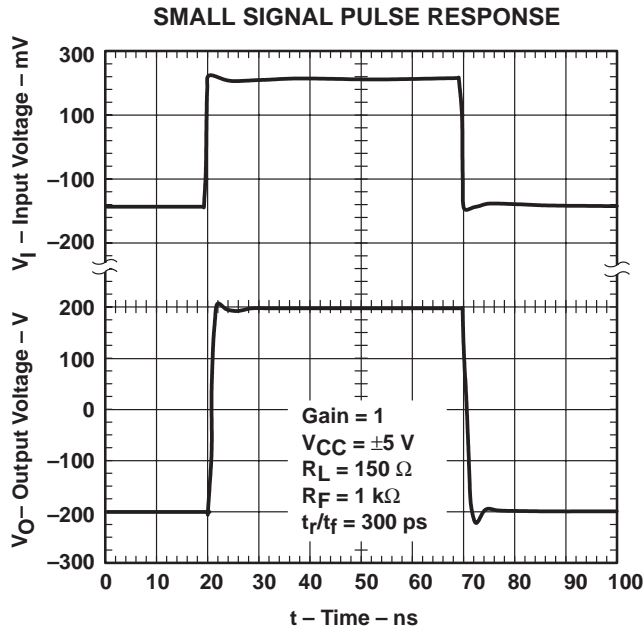

Figure 37

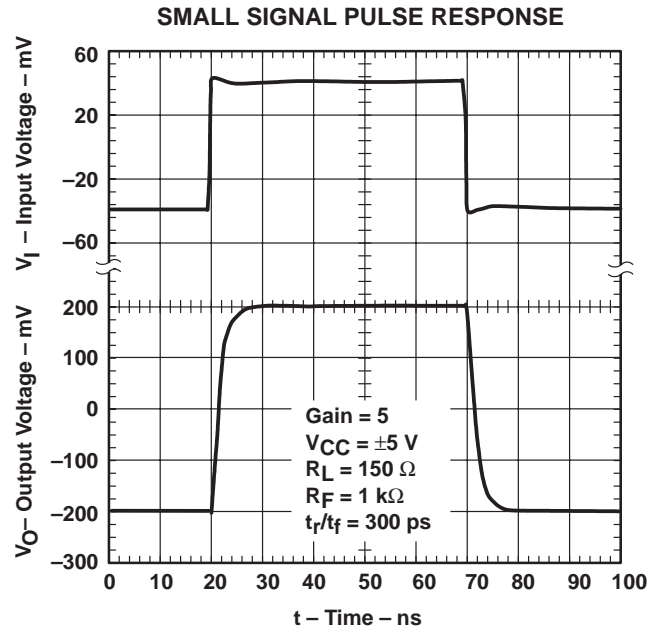

Figure 38

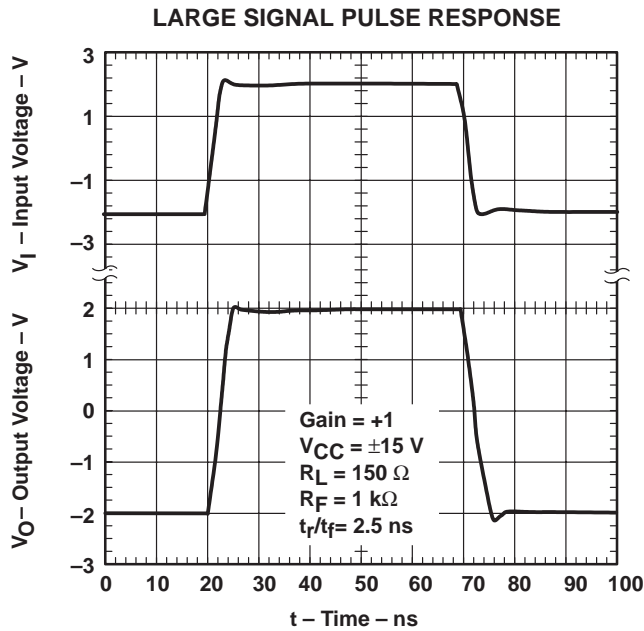

Figure 39

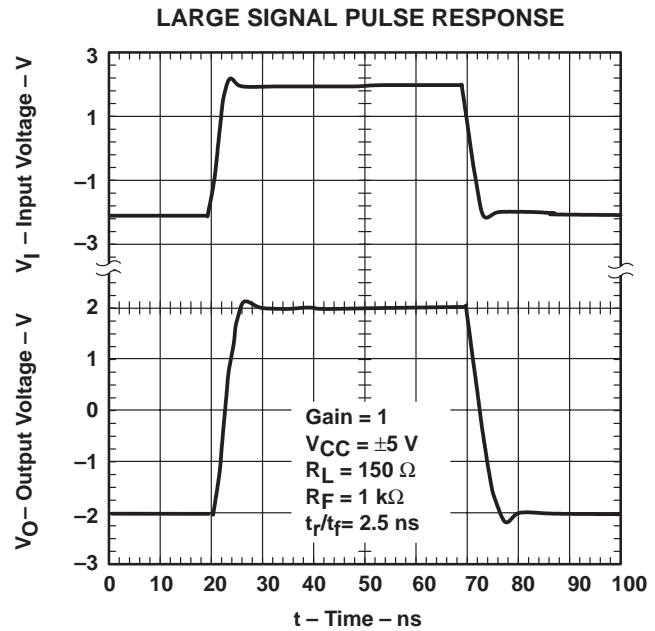

Figure 40



TYPICAL CHARACTERISTICS

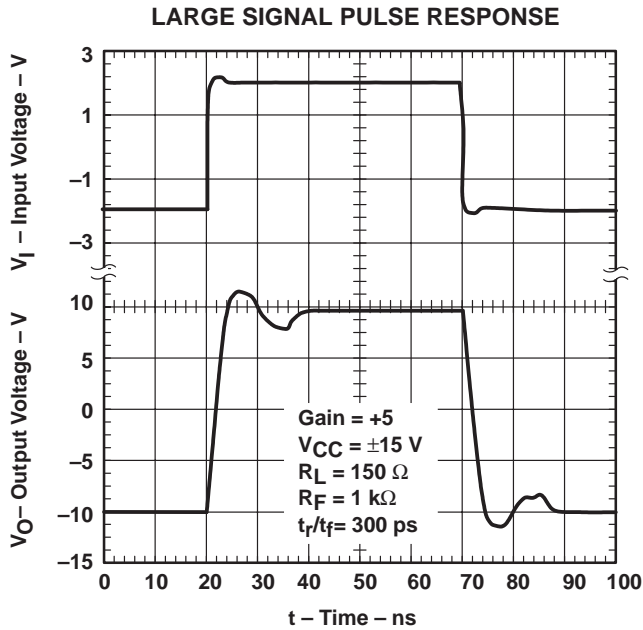

Figure 41

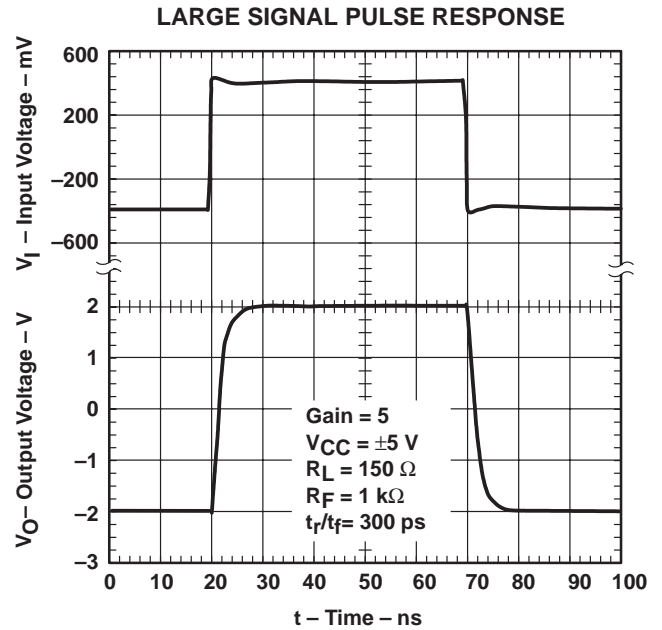

Figure 42

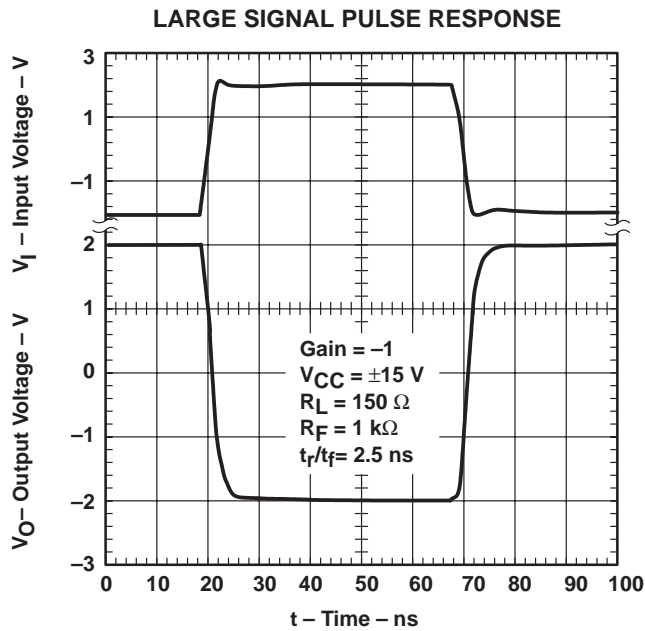

Figure 43

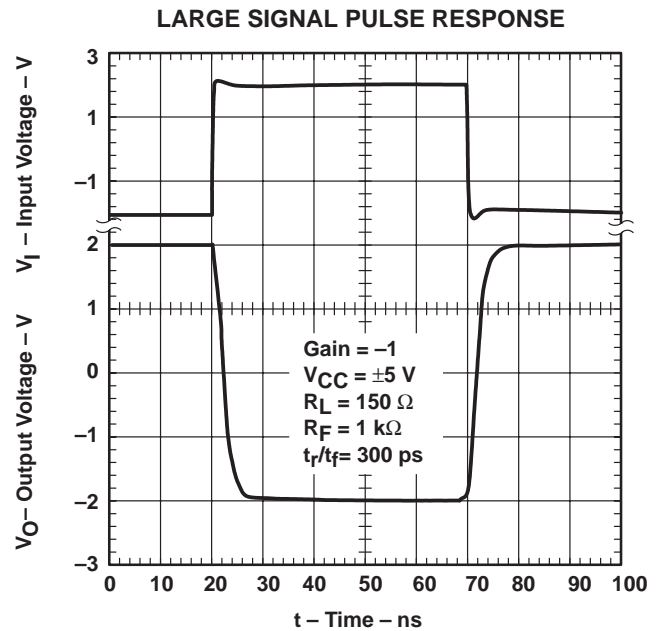

Figure 44

TYPICAL CHARACTERISTICS

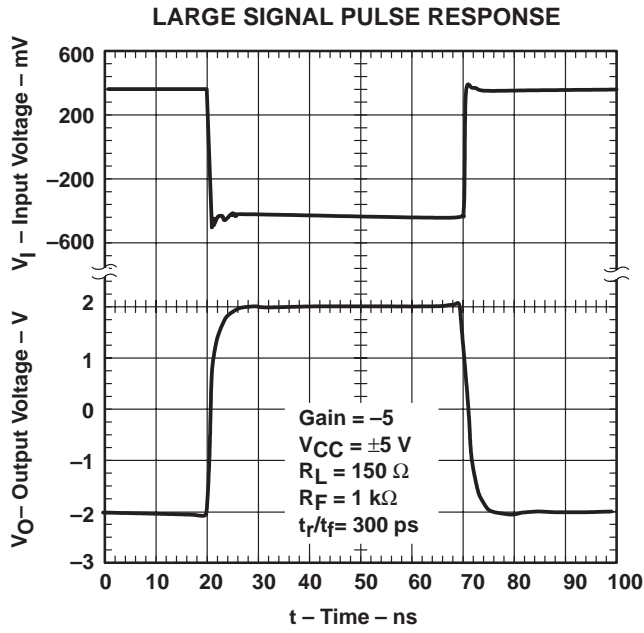

Figure 45

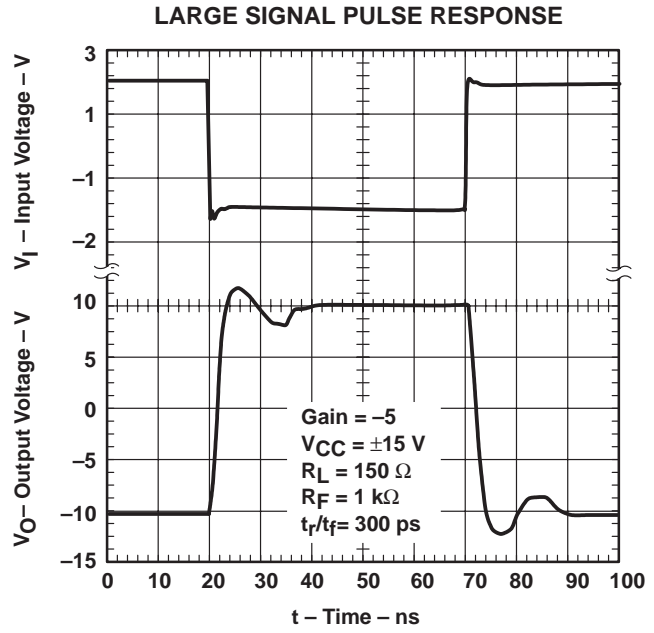

Figure 46

APPLICATION INFORMATION

recommended feedback and gain resistor values

The THS3001 is fabricated using Texas Instruments 30-V complementary bipolar process, HVBiCOM. This process provides the excellent isolation and extremely high slew rates, which result in excellent distortion characteristics.

As with all current feedback amplifiers, the bandwidth of the THS3001 is an inversely proportional function of the value of the feedback resistor. This can be seen from Figures 26 to 34. The recommended resistors for the optimum frequency response are shown in Table 1. These should be used as a starting point and once optimum values are found, 1% tolerance resistors should be used to maintain frequency response characteristics. For most applications, a feedback resistor value of 1 kΩ is recommended. This is a good compromise between bandwidth and phase margin that yields a very stable amplifier.

Consistent with current feedback amplifiers, increasing the gain is best accomplished by changing the gain resistor, not the feedback resistor. This is because the bandwidth of the amplifier is dominated by the feedback resistor value and internal dominant-pole capacitor. The ability to control the amplifier gain independently of the bandwidth constitutes a major advantage of current feedback amplifiers over conventional voltage feedback amplifiers. Therefore, once a frequency response is found suitable to a particular application, adjust the value of the gain resistor to increase or decrease the overall amplifier gain.

Finally, it is important to realize the effects of the feedback resistance on distortion. Increasing the resistance decreases the loop gain and increases the distortion. It is also important to know that decreasing load impedance increases total harmonic distortion (THD). Typically, the third order harmonic distortion increases more than the second order harmonic distortion.

Table 1. Recommended Resistor Values for Optimum Frequency Response

GAIN	R <sub>F</sub> for V <sub>CC</sub> = ±15 V	R <sub>F</sub> for V <sub>CC</sub> = ±5 V
1	1 kΩ	1 kΩ
2, -1	680 Ω	750 Ω
-2	620 Ω	620 Ω
5	560 Ω	620 Ω

offset voltage

The output offset voltage, (V<sub>OO</sub>) is the sum of the input offset voltage (V<sub>IO</sub>) and both input bias currents (I<sub>IB</sub>) times the corresponding gains. The following schematic and formula can be used to calculate the output offset voltage:

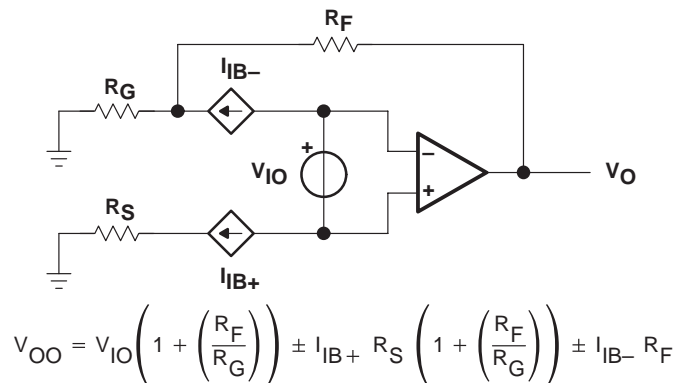

Figure 47. Output Offset Voltage Model

APPLICATION INFORMATION

noise calculations and noise figure

Noise can cause errors on very small signals. This is especially true for amplifying small signals coming over a transmission line or an antenna. The noise model for current feedback amplifiers (CFB) is the same as voltage feedback amplifiers (VFB). The only difference between the two is that the CFB amplifiers generally specify different current noise parameters for each input, while VFB amplifiers usually only specify one noise current parameter. The noise model is shown in Figure 48. This model includes all of the noise sources as follows:

- $e_n$  = amplifier internal voltage noise ( $nV/\sqrt{Hz}$ )
- $IN+$  = noninverting current noise ( $pA/\sqrt{Hz}$ )
- $IN-$  = inverting current noise ( $pA/\sqrt{Hz}$ )
- $e_{R_x}$  = thermal voltage noise associated with each resistor ( $e_{R_x} = 4 kTR_x$ )

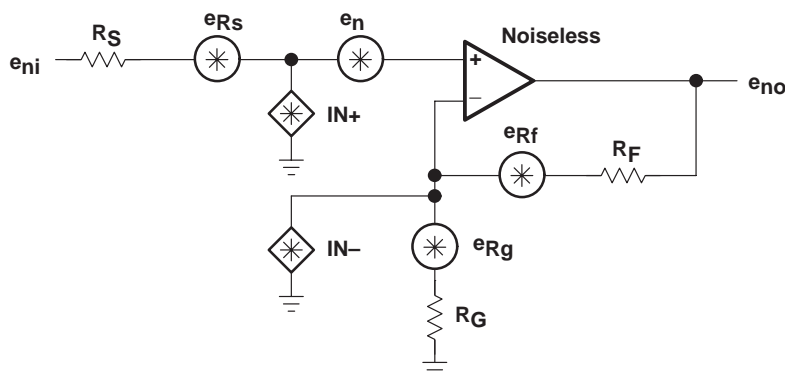

Figure 48. Noise Model

The total equivalent input noise density ( $e_{ni}$ ) is calculated by using the following equation:

$$e_{ni} = \sqrt{(e_n)^2 + (IN+ \times R_S)^2 + (IN- \times (R_F \parallel R_G))^2 + 4 kTR_S + 4 kT(R_F \parallel R_G)}$$

Where:

- k = Boltzmann's constant =  $1.380658 \times 10^{-23}$
- T = temperature in degrees Kelvin ( $273 + ^\circ C$ )
- $R_F \parallel R_G$  = Parallel resistance of  $R_F$  and  $R_G$

To get the equivalent output noise of the amplifier, just multiply the equivalent input noise density ( $e_{ni}$ ) by the overall amplifier gain ( $A_V$ ).

$$e_{no} = e_{ni} A_V = e_{ni} \left( 1 + \frac{R_F}{R_G} \right) \text{ (Noninverting Case)}$$

APPLICATION INFORMATION

noise calculations and noise figure (continued)

As the previous equations show, to keep noise at a minimum, small value resistors should be used. As the closed-loop gain is increased (by reducing  $R_G$ ), the input noise is reduced considerably because of the parallel resistance term. This leads to the general conclusion that the most dominant noise sources are the source resistor ( $R_S$ ) and the internal amplifier noise voltage ( $e_n$ ). Because noise is summed in a root-mean-squares method, noise sources smaller than 25% of the largest noise source can be effectively ignored. This can greatly simplify the formula and make noise calculations much easier.

This brings up another noise measurement usually preferred in RF applications, the noise figure (NF). Noise figure is a measure of noise degradation caused by the amplifier. The value of the source resistance must be defined and is typically 50  $\Omega$  in RF applications.

$$NF = 10\log \left[ \frac{e_{ni}^2}{e_{Rs}} \right]$$

Because the dominant noise components are generally the source resistance and the internal amplifier noise voltage, we can approximate noise figure as:

$$NF = 10\log \left[ 1 + \frac{\left[ (e_n)^2 + (IN + \times R_S)^2 \right]}{4 kTR_S} \right]$$

The Figure 49 shows the noise figure graph for the THS3001.

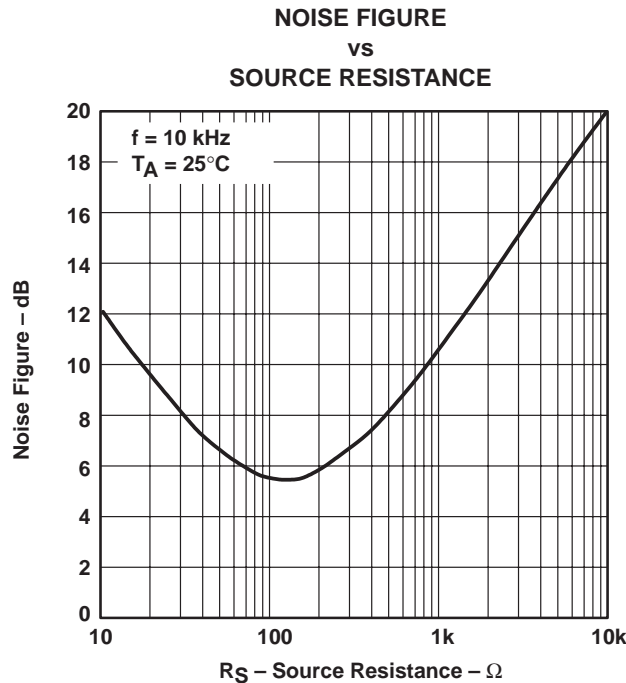

Figure 49. Noise Figure vs. Source Resistance

**APPLICATION INFORMATION**

**slew rate**

The slew rate performance of a current feedback amplifier, like the THS3001, is affected by many different factors. Some of these factors are external to the device, such as amplifier configuration and PCB parasitics, and others are internal to the device, such as available currents and node capacitance. Understanding some of these factors should help the PCB designer arrive at a more optimum circuit with fewer problems.

Whether the THS3001 is used in an inverting amplifier configuration or a noninverting configuration can impact the output slew rate. As can be seen from the specification tables as well as some of the figures in this data sheet, slew rate performance in the inverting configuration is faster than the noninverting configuration. This is because in the inverting configuration the input terminals of the amplifier are at a virtual ground and do not significantly change voltage as the input changes. Consequently, the time to charge any capacitance on these input nodes is less than for the noninverting configuration, where the input nodes actually do change in voltage an amount equal to the size of the input step. In addition, any PCB parasitic capacitance on the input nodes degrades the slew rate further simply because there is more capacitance to charge. Also, if the supply voltage ( $V_{CC}$ ) to the amplifier is reduced, slew rate decreases because there is less current available within the amplifier to charge the capacitance on the input nodes as well as other internal nodes.

Internally, the THS3001 has other factors that impact the slew rate. The amplifier's behavior during the slew rate transition varies slightly depending upon the rise time of the input. This is because of the way the input stage handles faster and faster input edges. Slew rates (as measured at the amplifier output) of less than about  $1500 \text{ V}/\mu\text{s}$  are processed by the input stage in a very linear fashion. Consequently, the output waveform smoothly transitions between initial and final voltage levels. This is shown in Figure 50. For slew rates greater than  $1500 \text{ V}/\mu\text{s}$ , additional slew-enhancing transistors present in the input stage begin to turn on to support these faster signals. The result is an amplifier with extremely fast slew rate capabilities. Figures 41 and 51 show waveforms for these faster slew rates. The additional aberrations present in the output waveform with these faster slewing input signals are due to the brief saturation of the internal current mirrors. This phenomenon, which typically lasts less than 20 ns, is considered normal operation and is not detrimental to the device in any way. If for any reason this type of response is not desired, then increasing the feedback resistor or slowing down the input signal slew rate reduces the effect.

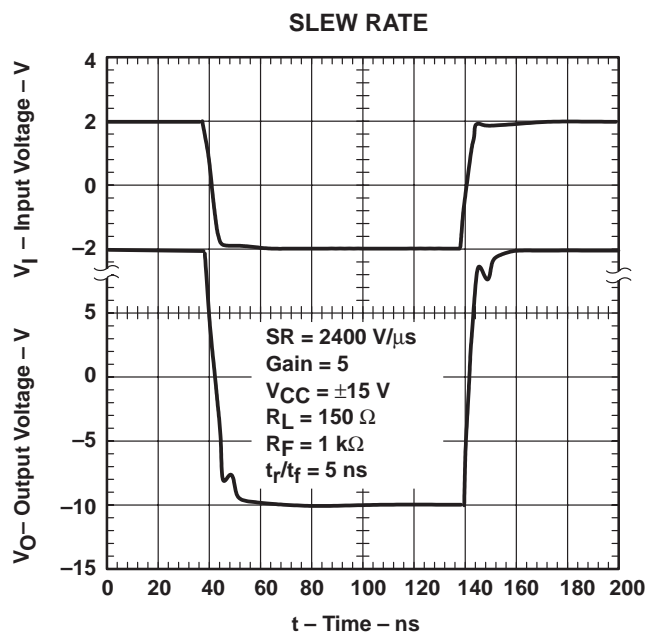
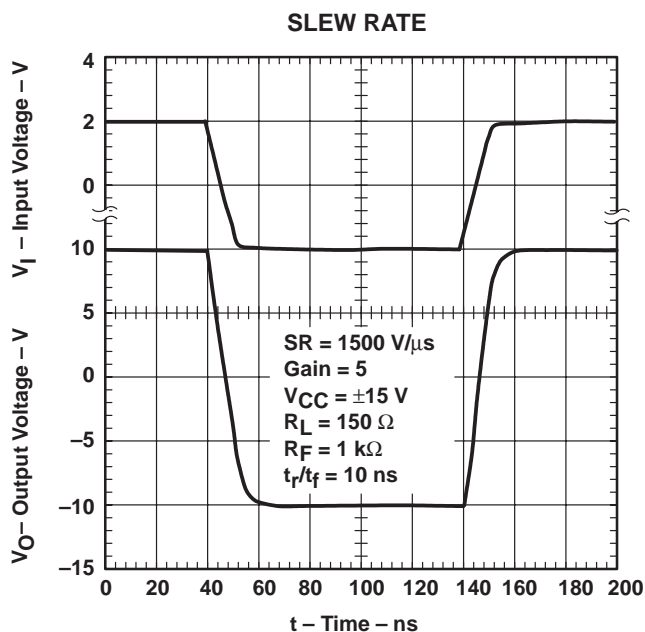

## APPLICATION INFORMATION

### driving a capacitive load

Driving capacitive loads with high performance amplifiers is not a problem as long as certain precautions are taken. The first is to realize that the THS3001 has been internally compensated to maximize its bandwidth and slew rate performance. When the amplifier is compensated in this manner, capacitive loading directly on the output will decrease the device's phase margin leading to high frequency ringing or oscillations. Therefore, for capacitive loads of greater than 10 pF, it is recommended that a resistor be placed in series with the output of the amplifier, as shown in Figure 52. A minimum value of 20  $\Omega$  should work well for most applications. For example, in 75- $\Omega$  transmission systems, setting the series resistor value to 75  $\Omega$  both isolates any capacitance loading and provides the proper line impedance matching at the source end.

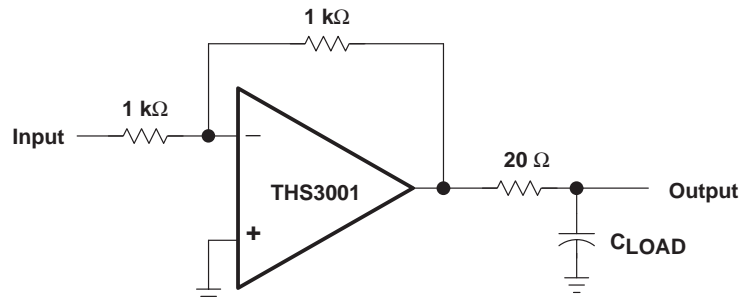

Figure 52. Driving a Capacitive Load

### PCB design considerations

Proper PCB design techniques in two areas are important to assure proper operation of the THS3001. These areas are high-speed layout techniques and thermal-management techniques. Because the THS3001 is a high-speed part, the following guidelines are recommended.

- Ground plane – It is essential that a ground plane be used on the board to provide all components with a low inductive ground connection. Although a ground connection directly to a terminal of the THS3001 is not necessarily required, it is recommended that the thermal pad of the package be tied to ground. This serves two functions: it provides a low inductive ground to the device substrate to minimize internal crosstalk, and it provides the path for heat removal.
- Input stray capacitance – To minimize potential problems with amplifier oscillation, the capacitance at the inverting input of the amplifiers must be kept to a minimum. To do this, PCB trace runs to the inverting input must be as short as possible, the ground plane must be removed under any etch runs connected to the inverting input, and external components should be placed as close as possible to the inverting input. This is especially true in the non-inverting configuration. An example of this can be seen in Figure 53, which shows what happens when a 1-pF capacitor is added to the inverting input terminal. The bandwidth increases at the expense of peaking. This is because some of the error current is flowing through the stray capacitor instead of the inverting node of the amplifier. Although, while the device is in the inverting mode, stray capacitance at the inverting input has a minimal effect. This is because the inverting node is at a *virtual ground* and the voltage does not fluctuate nearly as much as in the noninverting configuration. This can be seen in Figure 54, where a 10-pF capacitor adds only 0.35 dB of peaking. In general, as the gain of the system increases, the output peaking due to this capacitor decreases. While this can initially look like a faster and better system, overshoot and ringing are more likely to occur under fast transient conditions. So proper analysis of adding a capacitor to the inverting input node should be performed for stable operation.

APPLICATION INFORMATION

PCB design considerations (continued)

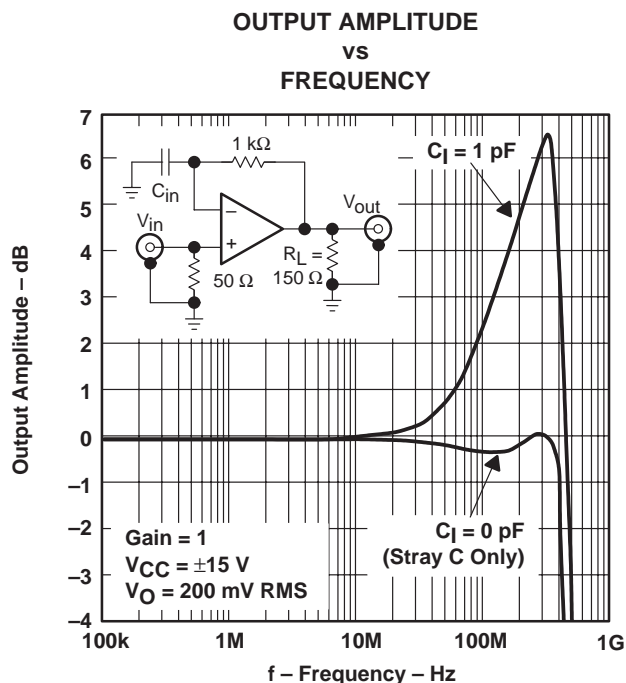

Figure 53

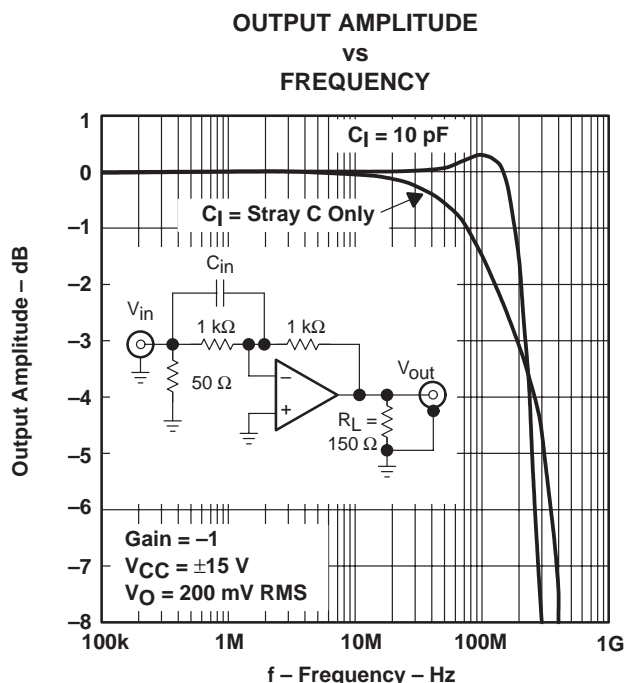

Figure 54

- Proper power supply decoupling – Use a minimum of a 6.8- $\mu$ F tantalum capacitor in parallel with a 0.1- $\mu$ F ceramic capacitor on each supply terminal. It may be possible to share the tantalum among several amplifiers depending on the application, but a 0.1- $\mu$ F ceramic capacitor should always be used on the supply terminal of every amplifier. In addition, the 0.1- $\mu$ F capacitor should be placed as close as possible to the supply terminal. As this distance increases, the inductance in the connecting etch makes the capacitor less effective. The designer should strive for distances of less than 0.1 inches between the device power terminal and the ceramic capacitors.

thermal information

The THS3001 incorporates output current limiting protection. Should the output become shorted to ground, the output current is automatically limited to the value given in the data sheet. While this protects the output against excessive current, the device internal power dissipation increases due to the high current and large voltage drop across the output transistors. Continuous output shorts are not recommended and could damage the device. Additionally, connection of the amplifier output to one of the supply rails ( $\pm V_{CC}$ ) is not recommended. Failure of the device is possible under this condition and should be avoided. But, the THS3001 does not incorporate thermal shutdown protection. Because of this, special attention must be paid to the device's power dissipation or failure may result.



**APPLICATION INFORMATION**

**thermal information (continued)**

The THS3001 comes in a SOIC 8-pin D-package. The thermal coefficient,  $\theta_{JA}$  is about 169°C/W for the D package. For a given  $\theta_{JA}$ , the maximum power dissipation is shown in Figure 55 and is calculated by the following formula:

$$P_D = \left( \frac{T_{MAX} - T_A}{\theta_{JA}} \right)$$

Where:

- $P_D$  = Maximum power dissipation of THS3001 (watts)
- $T_{MAX}$  = Absolute maximum junction temperature (150°C)
- $T_A$  = Free-ambient air temperature (°C)
- $\theta_{JA}$  = Thermal coefficient from die junction to ambient air (°C/W)

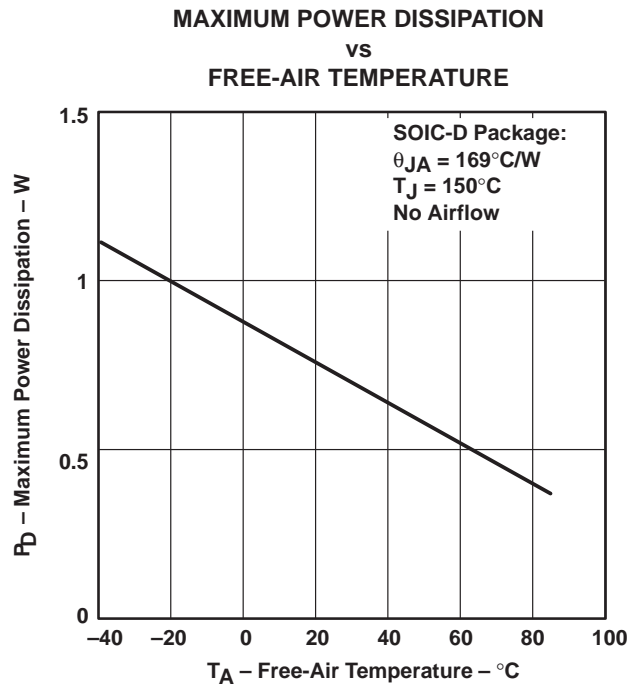

**Figure 55. Maximum Power Dissipation vs. Free-Air Temperature**

APPLICATION INFORMATION

general configurations

A common error for the first-time CFB user is to create a unity gain buffer amplifier by shorting the output directly to the inverting input. A CFB amplifier in this configuration will oscillate and is **not** recommended. The THS3001, like all CFB amplifiers, **must** have a feedback resistor for stable operation. Additionally, placing capacitors directly from the output to the inverting input is not recommended. This is because, at high frequencies, a capacitor has a very low impedance. This results in an unstable amplifier and should not be considered when using a current-feedback amplifier. Because of this, integrators and simple low-pass filters, which are easily implemented on a VFB amplifier, have to be designed slightly differently. If filtering is required, simply place an RC-filter at the noninverting terminal of the operational-amplifier (see Figure 56).

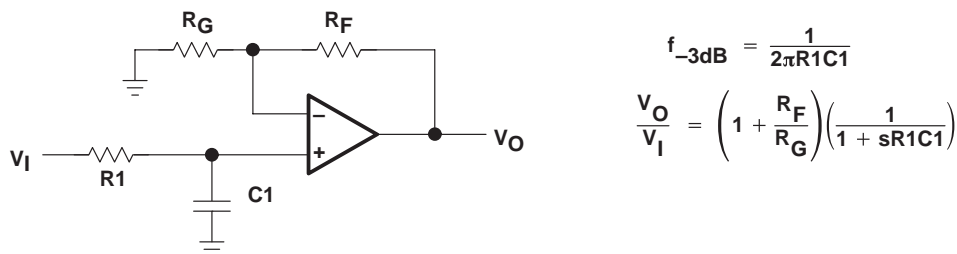

Figure 56. Single-Pole Low-Pass Filter

If a multiple pole filter is required, the use of a Sallen-Key filter can work very well with CFB amplifiers. This is because the filtering elements are not in the negative feedback loop and stability is not compromised. Because of their high slew-rates and high bandwidths, CFB amplifiers can create very accurate signals and help minimize distortion. An example is shown in Figure 57.

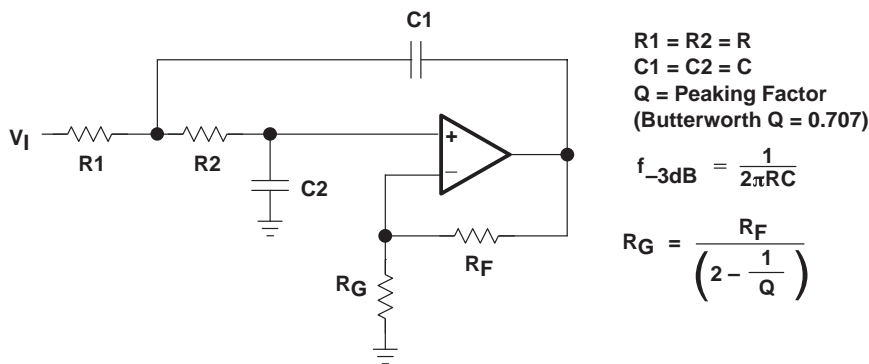

Figure 57. 2-Pole Low-Pass Sallen-Key Filter

There are two simple ways to create an integrator with a CFB amplifier. The first one shown in Figure 58 adds a resistor in series with the capacitor. This is acceptable because at high frequencies, the resistor is dominant and the feedback impedance never drops below the resistor value. The second one shown in Figure 59 uses positive feedback to create the integration. Caution is advised because oscillations can occur due to the positive feedback.

APPLICATION INFORMATION

general configurations (continued)

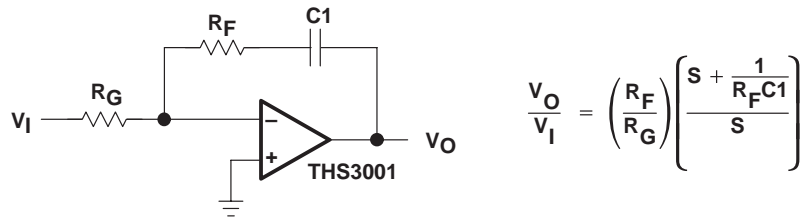

Figure 58. Inverting CFB Integrator

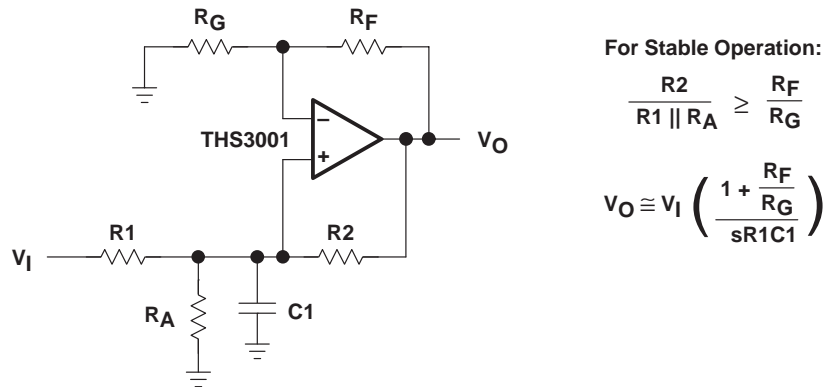

Figure 59. Non-Inverting CFB Integrator

Another good use for the THS3001 is as very good video distribution amplifiers. One characteristic of distribution amplifiers is the fact that the differential phase (DP) and the differential gain (DG) are compromised as the number of lines increases and the closed-loop gain increases (see Figures 22 to 25 for more information). Be sure to use termination resistors throughout the distribution system to minimize reflections and capacitive loading.

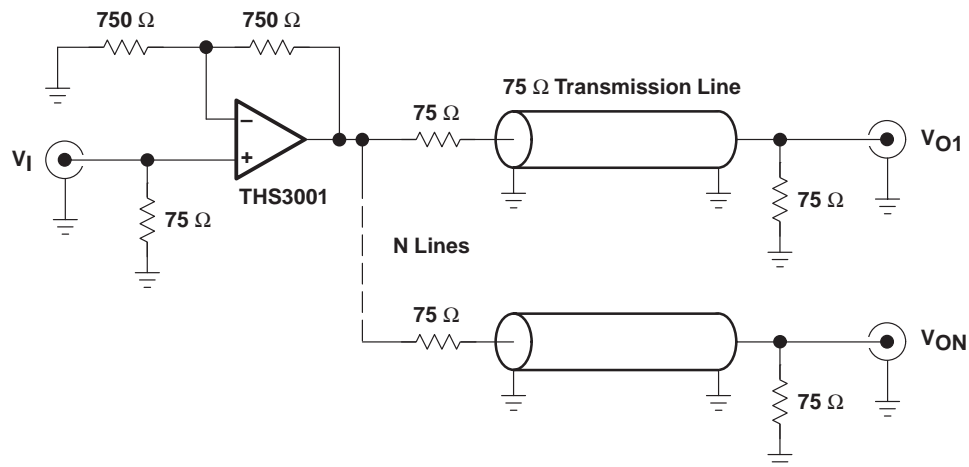

Figure 60. Video Distribution Amplifier Application

# THS3001

## 420-MHz HIGH-SPEED CURRENT-FEEDBACK AMPLIFIER

SLOS217 – JULY 1998

### APPLICATION INFORMATION

#### evaluation board

An evaluation board is available for the THS3001. This board has been configured for very low parasitic capacitance in order to realize the full performance of the amplifier. A schematic of the evaluation board is shown in Figure 61. The circuitry has been designed so that the amplifier may be used in either an inverting or noninverting configuration. To order the evaluation board contact your local TI sales office or distributor. Refer to literature number SLOP130.

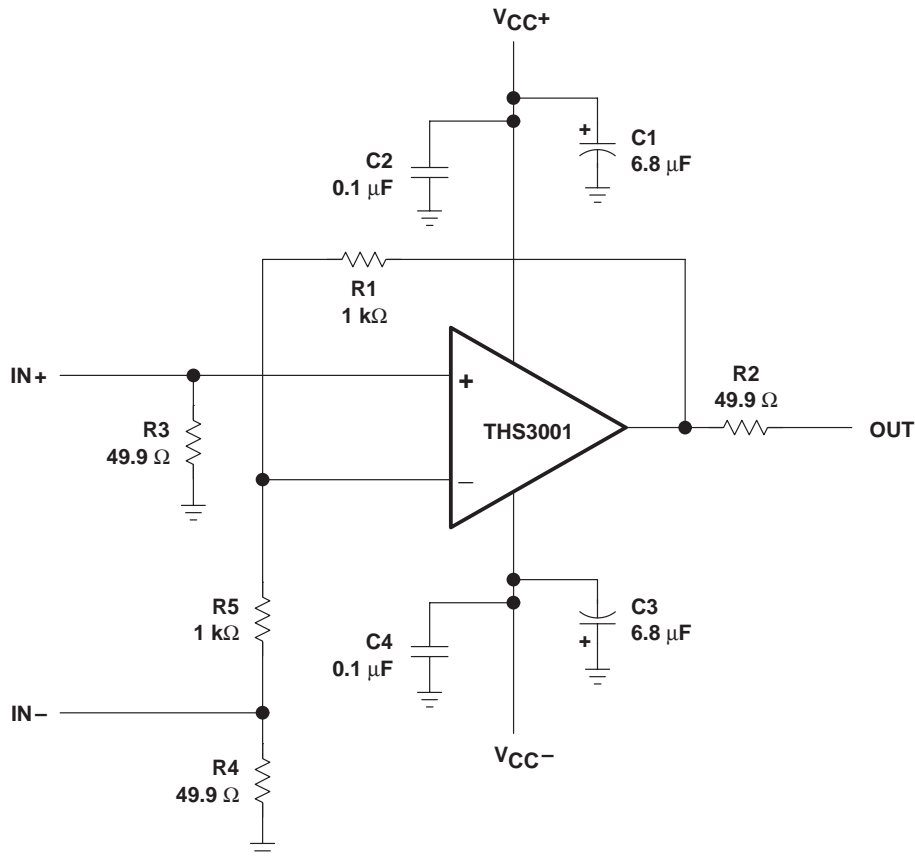

Figure 61. Evaluation Board Schematic

# THS3001 420-MHz HIGH-SPEED CURRENT-FEEDBACK AMPLIFIER

SLOS217 – JULY 1998

## MECHANICAL INFORMATION

**D (R-PDSO-G\*\*)**

**PLASTIC SMALL-OUTLINE PACKAGE**

14 PIN SHOWN

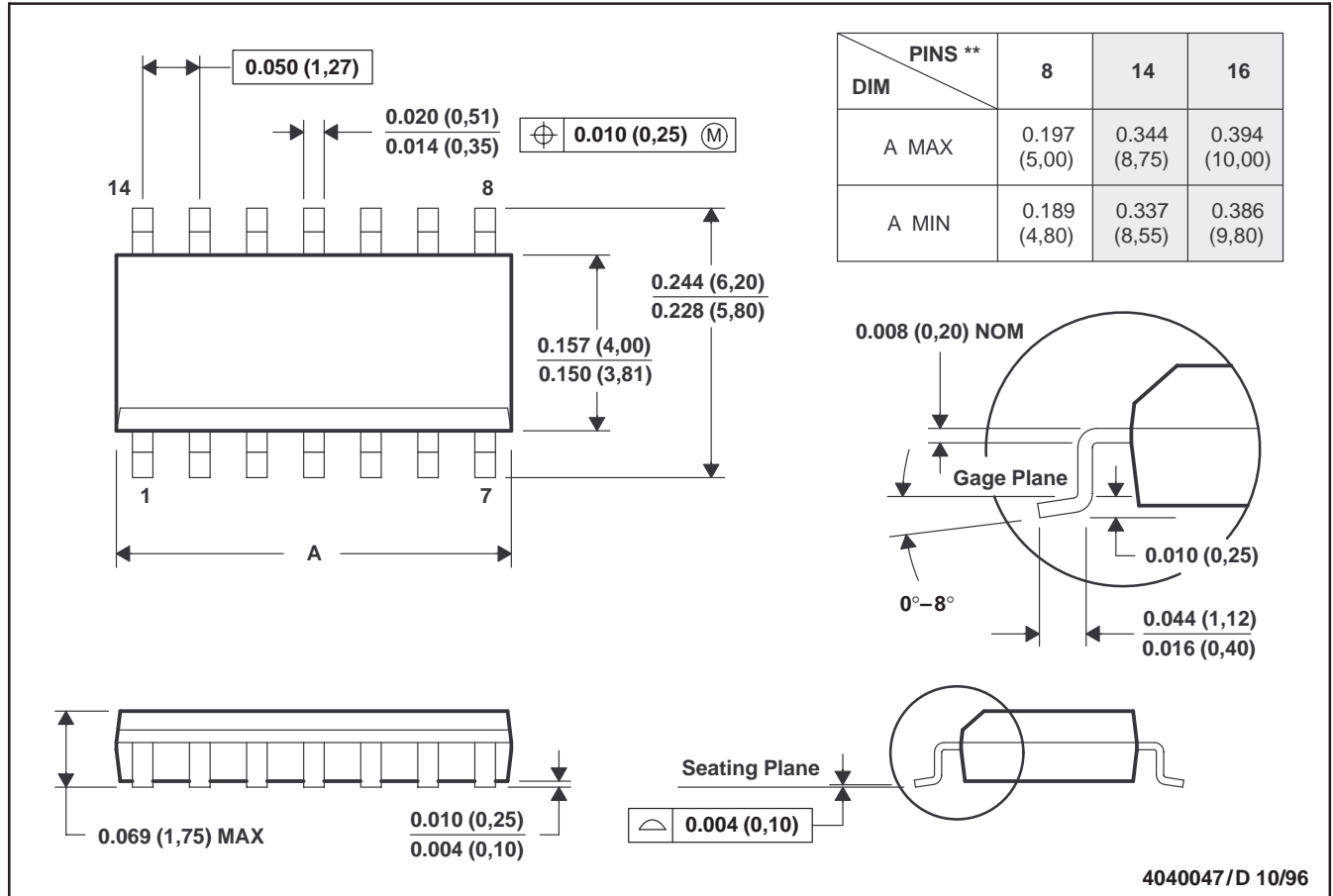

- NOTES: A. All linear dimensions are in inches (millimeters).  
 B. This drawing is subject to change without notice.  
 C. Body dimensions do not include mold flash or protrusion, not to exceed 0.006 (0,15).  
 D. Falls within JEDEC MS-012

## IMPORTANT NOTICE

Texas Instruments and its subsidiaries (TI) reserve the right to make changes to their products or to discontinue any product or service without notice, and advise customers to obtain the latest version of relevant information to verify, before placing orders, that information being relied on is current and complete. All products are sold subject to the terms and conditions of sale supplied at the time of order acknowledgement, including those pertaining to warranty, patent infringement, and limitation of liability.

TI warrants performance of its semiconductor products to the specifications applicable at the time of sale in accordance with TI's standard warranty. Testing and other quality control techniques are utilized to the extent TI deems necessary to support this warranty. Specific testing of all parameters of each device is not necessarily performed, except those mandated by government requirements.

CERTAIN APPLICATIONS USING SEMICONDUCTOR PRODUCTS MAY INVOLVE POTENTIAL RISKS OF DEATH, PERSONAL INJURY, OR SEVERE PROPERTY OR ENVIRONMENTAL DAMAGE ("CRITICAL APPLICATIONS"). TI SEMICONDUCTOR PRODUCTS ARE NOT DESIGNED, AUTHORIZED, OR WARRANTED TO BE SUITABLE FOR USE IN LIFE-SUPPORT DEVICES OR SYSTEMS OR OTHER CRITICAL APPLICATIONS. INCLUSION OF TI PRODUCTS IN SUCH APPLICATIONS IS UNDERSTOOD TO BE FULLY AT THE CUSTOMER'S RISK.

In order to minimize risks associated with the customer's applications, adequate design and operating safeguards must be provided by the customer to minimize inherent or procedural hazards.

TI assumes no liability for applications assistance or customer product design. TI does not warrant or represent that any license, either express or implied, is granted under any patent right, copyright, mask work right, or other intellectual property right of TI covering or relating to any combination, machine, or process in which such semiconductor products or services might be or are used. TI's publication of information regarding any third party's products or services does not constitute TI's approval, warranty or endorsement thereof.