

THS4021, THS4022 350-MHz LOW-NOISE HIGH-SPEED AMPLIFIERS

SLOS265B – SEPTEMBER 1999 – REVISED FEBRUARY 2000

- **Ultra-Low $1.5 \text{ nV}/\sqrt{\text{Hz}}$ Voltage Noise**
- **High Speed**
 - 350 MHz Bandwidth ($G = 10$, -3 dB)
 - 470 $\text{V}/\mu\text{s}$ Slew Rate
 - 40 ns Settling Time (0.1%)
- **Stable at a Gain of 10 (-9) or Greater**
- **High Output Drive, $I_O = 100 \text{ mA}$ (typ)**
- **Excellent Video Performance**
 - 17 MHz Bandwidth (0.1 dB, $G = 10$)
 - 0.02% Differential Gain
 - 0.08° Differential Phase
- **Very Low Distortion**
 - THD = -68 dBc ($f = 1 \text{ MHz}$, $R_L = 150 \Omega$)
- **Wide Range of Power Supplies**
 - $V_{CC} = \pm 5 \text{ V}$ to $\pm 15 \text{ V}$
- **Available in Standard SOIC or MSOP PowerPAD™ Package**
- **Evaluation Module Available**

description

The THS4021 and THS4022 are ultra-low voltage noise, high-speed voltage feedback amplifiers that are ideal for applications requiring low voltage noise, including communication and imaging. The signal-amplifier THS4021 and the dual-amplifier THS4022 offer very good ac performance with 350-MHz bandwidth, 470-V/ μs slew rate, and 40-ns settling time (0.1%). The THS4021 and THS4022 are stable at gains of 10 (-9) or greater. These amplifiers have a high drive capability of 100 mA and draw only 7.8-mA supply current per channel. With total harmonic distortion (THD) of -68 dBc at $f = 1 \text{ MHz}$, the THS4021 and THS4022 are ideally suited for applications requiring low distortion.

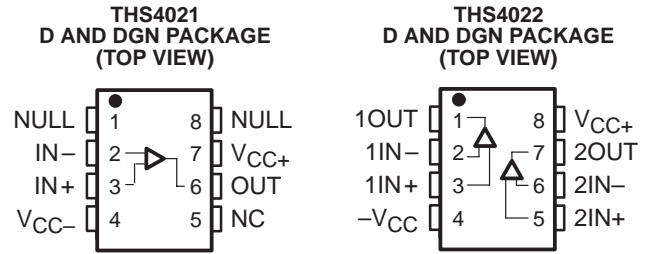

NC – No internal connection



Cross Section View Showing PowerPAD Option (DGN)

VOLTAGE & CURRENT NOISE vs FREQUENCY

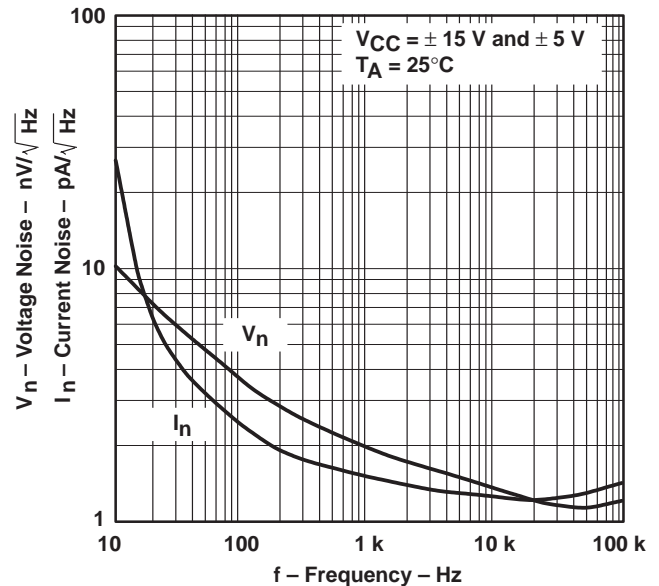

Figure 1

| RELATED DEVICES | |
|-----------------|--|
| DEVICE | DESCRIPTION |
| THS4011/2 | 290-MHz Low Distortion High-Speed Amplifiers |
| THS4031/2 | 100-MHz Low Noise High-Speed Amplifiers |
| THS4061/2 | 180-MHz High-Speed Amplifiers |



CAUTION: The THS4021 and THS4022 provide ESD protection circuitry. However, permanent damage can still occur if this device is subjected to high-energy electrostatic discharges. Proper ESD precautions are recommended to avoid any performance degradation or loss of functionality.



Please be aware that an important notice concerning availability, standard warranty, and use in critical applications of Texas Instruments semiconductor products and disclaimers thereto appears at the end of this data sheet.

PowerPAD is a trademark of Texas Instruments Incorporated.

PRODUCTION DATA information is current as of publication date. Products conform to specifications per the terms of Texas Instruments standard warranty. Production processing does not necessarily include testing of all parameters.



POST OFFICE BOX 655303 • DALLAS, TEXAS 75265

Copyright © 2000, Texas Instruments Incorporated

THS4021, THS4022 350-MHz LOW-NOISE HIGH-SPEED AMPLIFIERS

SLOS265B – SEPTEMBER 1999 – REVISED FEBRUARY 2000

AVAILABLE OPTIONS

| T _A | NUMBER OF CHANNELS | PACKAGED DEVICES | | MSOP SYMBOL | EVALUATION MODULE |
|----------------|--------------------|----------------------------|---------------------|-------------|-------------------|
| | | PLASTIC SMALL OUTLINE† (D) | PLASTIC MSOP† (DGN) | | |
| 0°C to 70°C | 1 | THS4021CD | THS4021CDGN | ACK | THS4021EVM |
| | 2 | THS4022CD | THS4022CDGN | ACL | THS4022EVM |
| -40°C to 85°C | 1 | THS4021ID | THS4021IDGN | ACA | — |
| | 2 | THS4022ID | THS4022IDGN | ACB | — |

† The D and DGN packages are available taped and reeled. Add an R suffix to the device type (i.e., THS4021CDGN).

functional block diagram

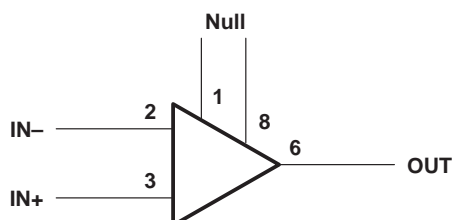

Figure 2. THS4021 – Single Channel

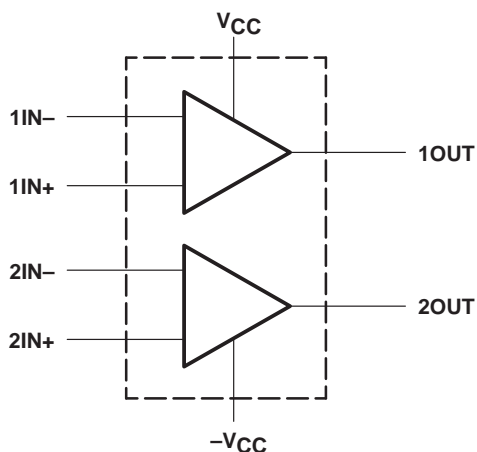

Figure 3. THS4022 – Dual Channel

absolute maximum ratings over operating free-air temperature (unless otherwise noted)†

| | |
|--|------------------------------|
| Supply voltage, V_{CC} | ±16.5 V |
| Input voltage, V_I | ± V_{CC} |
| Output current, I_O | 150 mA |
| Differential input voltage, V_{IO} | ±4 V |
| Continuous total power dissipation | See Dissipation Rating Table |
| Maximum junction temperature, T_J | 150°C |
| Operating free-air temperature, T_A : C-suffix | 0°C to 70°C |
| I-suffix | –40°C to 85°C |
| Storage temperature, T_{stg} | –65°C to 150°C |
| Lead temperature 1,6 mm (1/16 inch) from case for 10 seconds | 300°C |

† Stresses beyond those listed under “absolute maximum ratings” may cause permanent damage to the device. These are stress ratings only and functional operation of the device at these or any other conditions beyond those indicated under “recommended operating conditions” is not implied. Exposure to absolute-maximum-rated conditions for extended periods may affect device reliability.

DISSIPATION RATING TABLE

| PACKAGE | θ_{JA} (°C/W) | θ_{JC} (°C/W) | $T_A = 25^\circ\text{C}$ POWER RATING |
|---------|-------------------------|-------------------------|--|
| D | 167‡ | 38.3 | 740 mW |
| DGN§ | 58.4 | 4.7 | 2.14 W |

‡ This data was taken using the JEDEC standard Low-K test PCB. For the JEDEC Proposed High-K test PCB, the θ_{JA} is 95°C/W with a power rating at $T_A = 25^\circ\text{C}$ of 1.32 W.

§ This data was taken using 2 oz. trace and copper pad that is soldered directly to a 3 in. × 3 in. PC. For further information, refer to *Application Information* section of this data sheet.

recommended operating conditions

| | | MIN | NOM | MAX | UNIT |
|---|---------------|------|-----|-----|------|
| Supply voltage, V_{CC+} and V_{CC-} | Dual supply | ±4.5 | | ±16 | V |
| | Single supply | 9 | | 32 | |
| Operating free-air temperature, T_A | C-suffix | 0 | | 70 | °C |
| | I-suffix | –40 | | 85 | |

THS4021, THS4022

350-MHz LOW-NOISE HIGH-SPEED AMPLIFIERS

SLOS265B – SEPTEMBER 1999 – REVISED FEBRUARY 2000

electrical characteristics at $T_A = 25^\circ\text{C}$, $V_{CC} = \pm 15\text{ V}$, $R_L = 150\ \Omega$ (unless otherwise noted)

dynamic performance

| PARAMETER | | TEST CONDITIONS | | MIN | TYP | MAX | UNIT |
|-----------------------|--|---|------------|------|-----|-----|------------------|
| BW | Small-signal bandwidth (–3 dB) | $V_{CC} = \pm 15\text{ V}$ | Gain = 10 | | 350 | | MHz |
| | | $V_{CC} = \pm 5\text{ V}$ | | | 280 | | |
| | | $V_{CC} = \pm 15\text{ V}$ | Gain = 20 | | 80 | | MHz |
| | | $V_{CC} = \pm 5\text{ V}$ | | | 70 | | |
| | Bandwidth for 0.1 dB flatness | $V_{CC} = \pm 15\text{ V}$ | Gain = 10 | | 17 | | MHz |
| | | $V_{CC} = \pm 5\text{ V}$ | | | 17 | | |
| Full power bandwidth† | $V_{O(pp)} = 20\text{ V}$, $V_{CC} = \pm 15\text{ V}$ | | | 3.7 | | MHz | |
| | $V_{O(pp)} = 5\text{ V}$, $V_{CC} = \pm 5\text{ V}$ | | | 11.8 | | | |
| SR | Slew rate‡ | $V_{CC} = \pm 15\text{ V}$, 10-V step, | Gain = 10 | | 470 | | V/ μs |
| | | $V_{CC} = \pm 5\text{ V}$, 5-V step | | | 370 | | |
| t_s | Settling time to 0.1% | $V_{CC} = \pm 15\text{ V}$, 5-V step | Gain = –10 | | 40 | | ns |
| | | $V_{CC} = \pm 5\text{ V}$, 2-V step | | | 50 | | |
| | Settling time to 0.01% | $V_{CC} = \pm 15\text{ V}$, 5-V step | Gain = –10 | | 145 | | ns |
| | | $V_{CC} = \pm 5\text{ V}$, 2-V step | | | 150 | | |

† Slew rate is measured from an output level range of 25% to 75%.

‡ Full power bandwidth = slew rate / $2\pi V_{O(\text{Peak})}$.

noise/distortion performance

| PARAMETER | | TEST CONDITIONS | | MIN | TYP | MAX | UNIT |
|-----------|---|--|------------------------------------|---|-----|----------------|------------------------------|
| THD | Total harmonic distortion | $V_{O(pp)} = 2\text{ V}$, $f = 1\text{ MHz}$, Gain = 2 | $V_{CC} = \pm 15\text{ V}$ | $R_L = 150\ \Omega$ | | –68 | dBc |
| | | | | $R_L = 1\text{ k}\Omega$ | | –77 | |
| | | | $V_{CC} = \pm 5\text{ V}$ | $R_L = 150\ \Omega$ | | –69 | |
| | | | | $R_L = 1\text{ k}\Omega$ | | –78 | |
| V_n | Input voltage noise | $V_{CC} = \pm 5\text{ V}$ or $\pm 15\text{ V}$, $f = 10\text{ kHz}$ | | | 1.5 | | $\text{nV}/\sqrt{\text{Hz}}$ |
| I_n | Input current noise | $V_{CC} = \pm 5\text{ V}$ or $\pm 15\text{ V}$, $f = 10\text{ kHz}$ | | | 2 | | $\text{pA}/\sqrt{\text{Hz}}$ |
| | Differential gain error | Gain = 2, 40 IRE modulation, | NTSC, $\pm 100\text{ IRE ramp}$ | $V_{CC} = \pm 15\text{ V}$ $V_{CC} = \pm 5\text{ V}$ | | 0.02% | |
| | Differential phase error | Gain = 2, 40 IRE modulation, | NTSC, $\pm 100\text{ IRE ramp}$ | $V_{CC} = \pm 15\text{ V}$ $V_{CC} = \pm 5\text{ V}$ | | 0.08° 0.06° | |
| X_T | Channel-to-channel crosstalk (THS4022 only) | $V_{CC} = \pm 5\text{ V}$ or $\pm 15\text{ V}$, $f = 1\text{ MHz}$ | | | | –60 | dB |



POST OFFICE BOX 655303 • DALLAS, TEXAS 75265

THS4021, THS4022

350-MHz LOW-NOISE HIGH-SPEED AMPLIFIERS

SLOS265B – SEPTEMBER 1999 – REVISED FEBRUARY 2000

electrical characteristics at $T_A = 25^\circ\text{C}$, $V_{CC} = \pm 15\text{ V}$, $R_L = 150\ \Omega$ (unless otherwise noted) (continued)

dc performance

| PARAMETER | | TEST CONDITIONS | | MIN | TYP | MAX | UNIT |
|-------------------------------|---|--|--|-----|-----|-----|------------------------------|
| Open loop gain | | $V_{CC} = \pm 15\text{ V}$, $R_L = 1\text{ k}\Omega$ | $V_O = \pm 10\text{ V}$, $T_A = 25^\circ\text{C}$ | 40 | 60 | | V/mV |
| | | | $T_A = \text{full range}$ | 35 | | | |
| | | $V_{CC} = \pm 5\text{ V}$, $R_L = 250\ \Omega$ | $V_O = \pm 2.5\text{ V}$, $T_A = 25^\circ\text{C}$ | 20 | 35 | | V/mV |
| | | | $T_A = \text{full range}$ | 15 | | | |
| V_{OS} Input offset voltage | $V_{CC} = \pm 5\text{ V or } \pm 15\text{ V}$ | | $T_A = 25^\circ\text{C}$ | 0.5 | 2 | | mV |
| $T_A = \text{full range}$ | | | | 3 | | | |
| Offset voltage drift | | | $T_A = \text{full range}$ | 15 | | | $\mu\text{V}/^\circ\text{C}$ |
| I_{IB} Input bias current | | | $T_A = 25^\circ\text{C}$ | 3 | 6 | | μA |
| | $T_A = \text{full range}$ | 6 | | | | | |
| I_{OS} Input offset current | | | $T_A = 25^\circ\text{C}$ | 30 | 250 | | nA |
| Offset current drift | | | $T_A = \text{full range}$ | 400 | | | |
| | $T_A = \text{full range}$ | | | 0.3 | | | $\text{nA}/^\circ\text{C}$ |

input characteristics

| PARAMETER | | TEST CONDITIONS | | MIN | TYP | MAX | UNIT |
|---|--|--|----------------------------|------------|------------|-----|------------|
| V_{ICR} Common-mode input voltage range | | | $V_{CC} = \pm 15\text{ V}$ | ± 13.8 | ± 14.3 | | V |
| | | | $V_{CC} = \pm 5\text{ V}$ | ± 3.8 | ± 4.3 | | |
| CMRR Common mode rejection ratio | | $V_{CC} = \pm 15\text{ V}$, $V_{ICR} = \pm 12\text{ V}$, $T_A = \text{full range}$ | 74 | 95 | | | dB |
| r_i Input resistance | | | | 1 | | | M Ω |
| C_i Input capacitance | | | | 1.5 | | | pF |

output characteristics

| PARAMETER | | TEST CONDITIONS | | MIN | TYP | MAX | UNIT | |
|---|--|---|--------------------------|----------------------------|------------|------------|----------|---|
| V_O Output voltage swing | | $V_{CC} = \pm 15\text{ V}$ | $R_L = 250\ \Omega$ | ± 12 | ± 12.5 | | V | |
| | | | $R_L = 150\ \Omega$ | ± 3 | ± 3.3 | | | |
| | | $V_{CC} = \pm 5\text{ V}$ | $R_L = 1\text{ k}\Omega$ | $V_{CC} = \pm 15\text{ V}$ | ± 13 | ± 13.5 | | V |
| | | | | $V_{CC} = \pm 5\text{ V}$ | ± 3.4 | ± 3.8 | | |
| I_O Output current | | $V_{CC} = \pm 15\text{ V}$, $V_{CC} = \pm 5\text{ V}$ | $R_L = 20\ \Omega$ | 80 | 100 | | mA | |
| | | | | 50 | 75 | | | |
| I_{SC} Short-circuit current [†] | | $V_{CC} = \pm 15\text{ V}$ | | 150 | | | mA | |
| R_O Output resistance [†] | | Open loop | | 13 | | | Ω | |

[†] Observe power dissipation ratings to keep the junction temperature below the absolute maximum rating when the output is heavily loaded or shorted. See the absolute maximum ratings section of this data sheet for more information.

power supply

| PARAMETER | | TEST CONDITIONS | | MIN | TYP | MAX | UNIT |
|---|--|---|---------------------------|-----------|------|------------|------|
| V_{CC} Supply voltage operating range | | | Dual supply | ± 4.5 | | ± 16.5 | V |
| | | | Single supply | 9 | | 33 | |
| I_{CC} Supply current (per amplifier) | | $V_{CC} = \pm 15\text{ V}$ | $T_A = 25^\circ\text{C}$ | 7.8 | 10 | | mA |
| | | | $T_A = \text{full range}$ | | 11 | | |
| | | $V_{CC} = \pm 5\text{ V}$ | $T_A = 25^\circ\text{C}$ | 6.7 | 9 | | |
| | | | $T_A = \text{full range}$ | | 10.5 | | |
| PSRR Power supply rejection ratio | | $V_{CC} = \pm 5\text{ V or } \pm 15\text{ V}$ | $T_A = \text{full range}$ | 80 | 95 | | dB |



TYPICAL CHARACTERISTICS

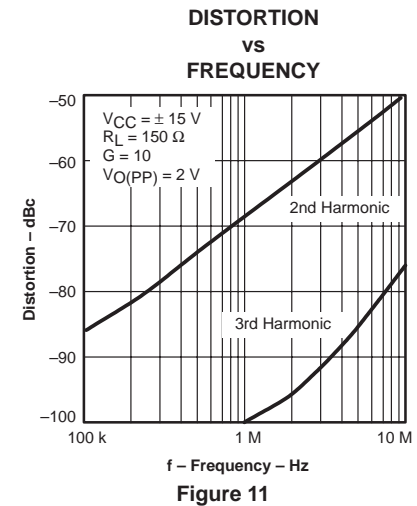
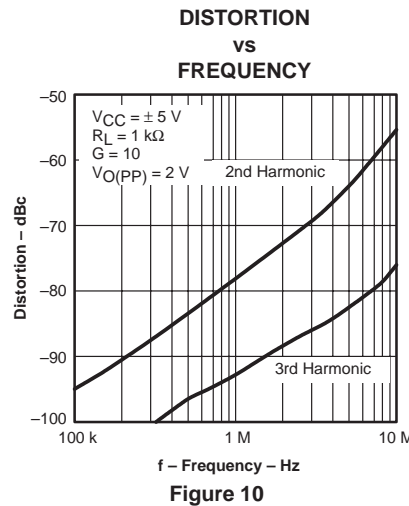
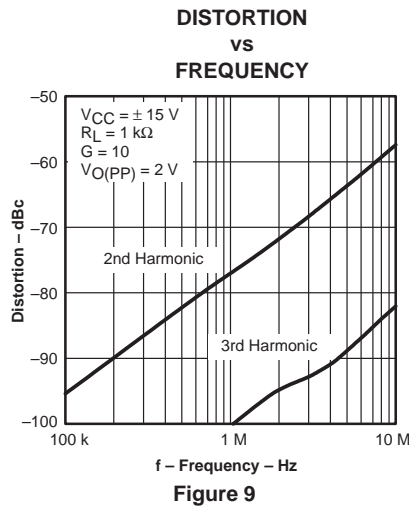
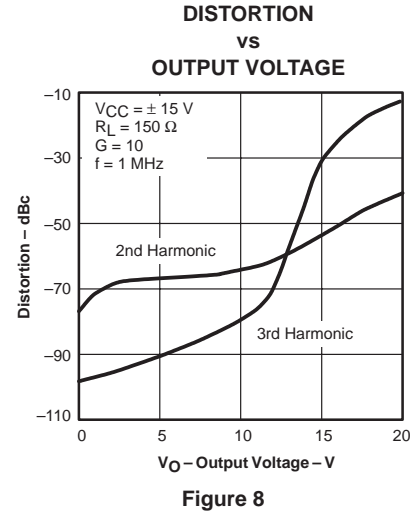
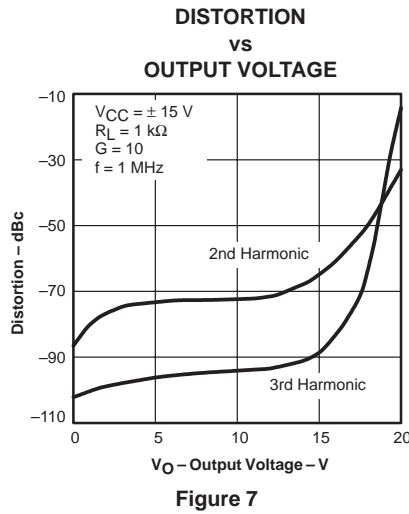
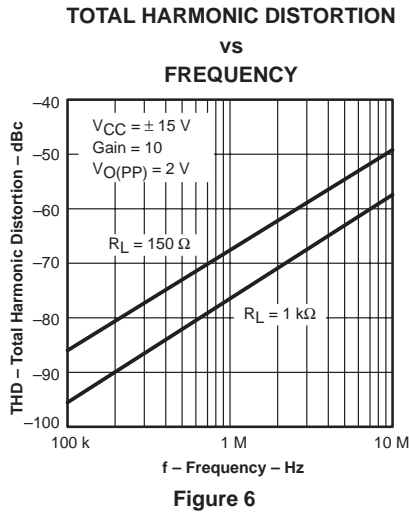
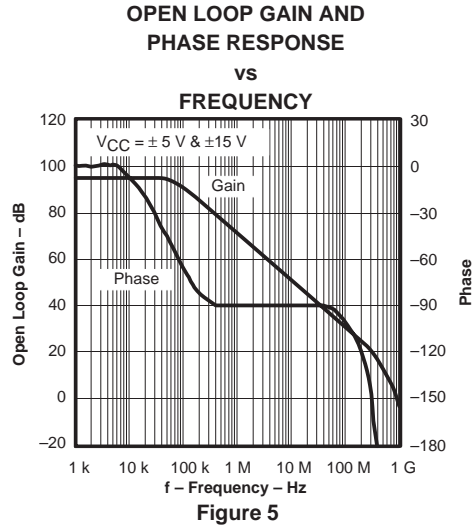
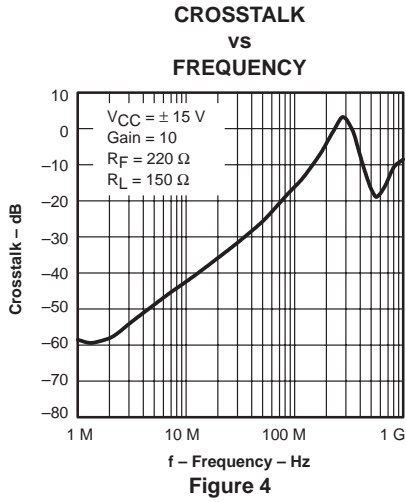

TYPICAL CHARACTERISTICS

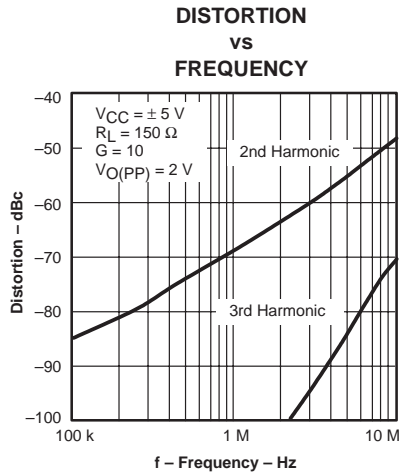

Figure 12

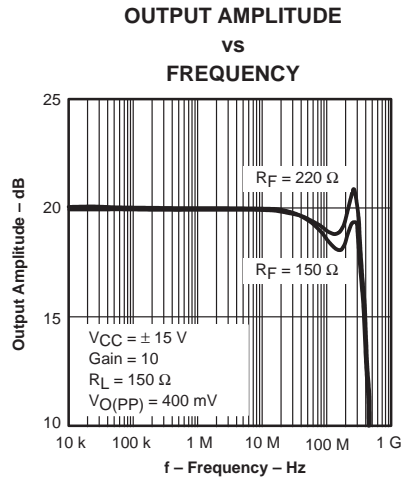

Figure 13

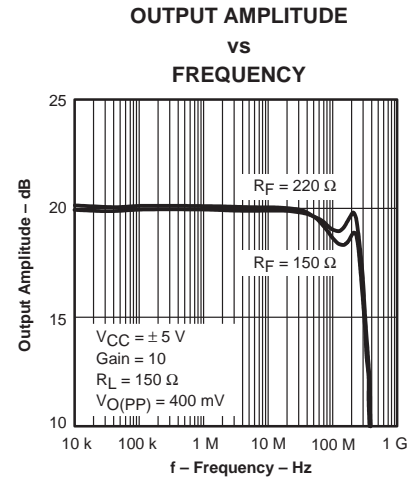

Figure 14

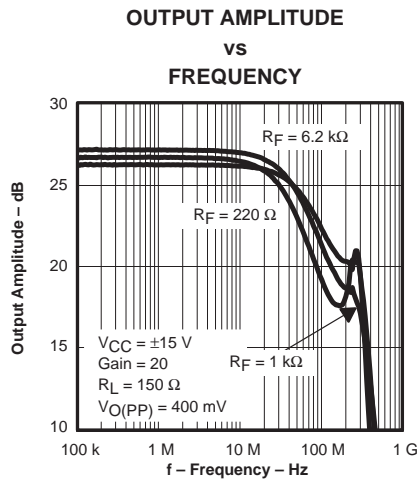

Figure 15

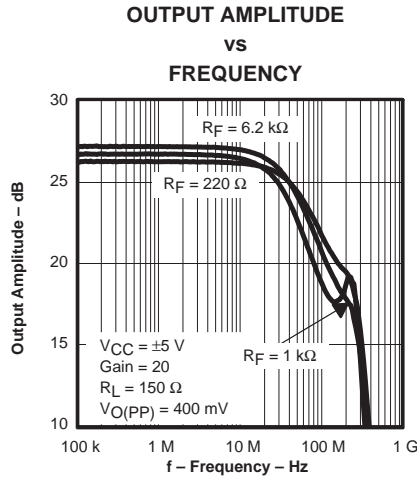

Figure 16

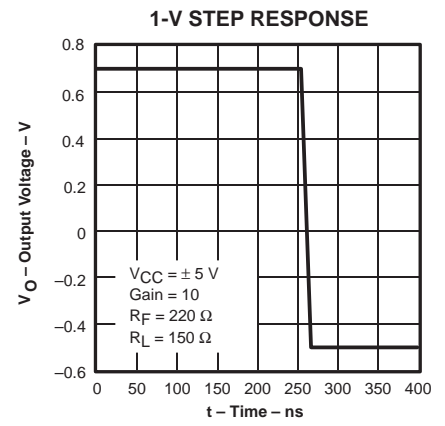

Figure 17

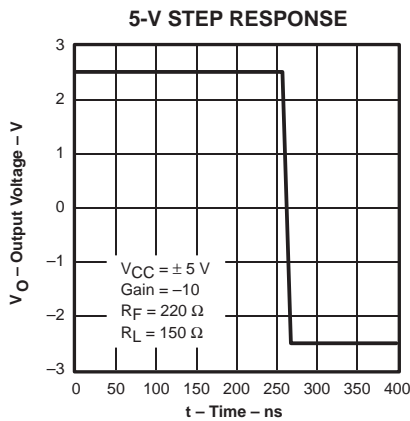

Figure 18

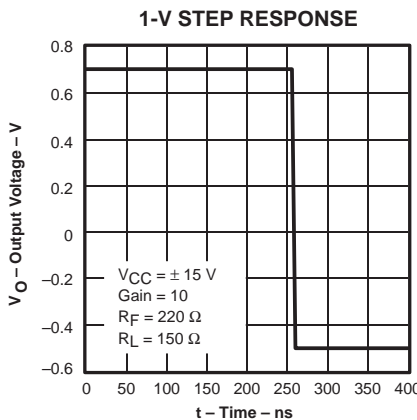

Figure 19

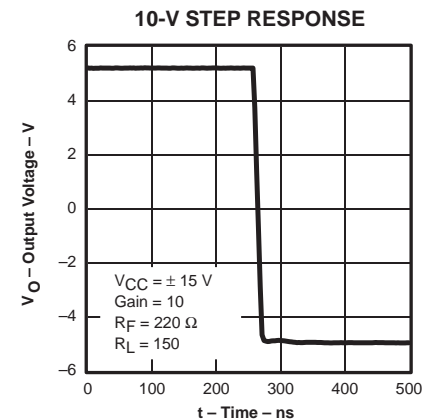

Figure 20

THS4021, THS4022 350-MHz LOW-NOISE HIGH-SPEED AMPLIFIERS

SLOS265B – SEPTEMBER 1999 – REVISED FEBRUARY 2000

TYPICAL CHARACTERISTICS

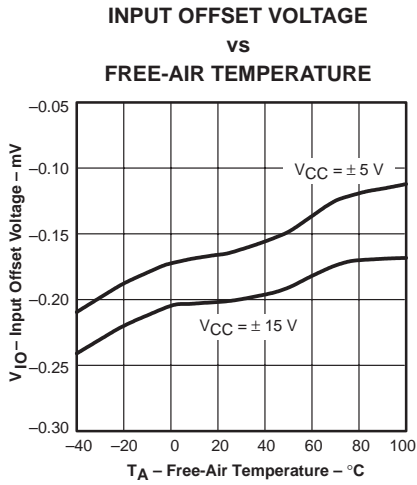

Figure 21

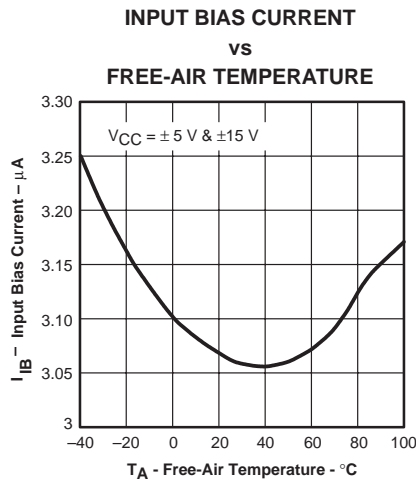

Figure 22

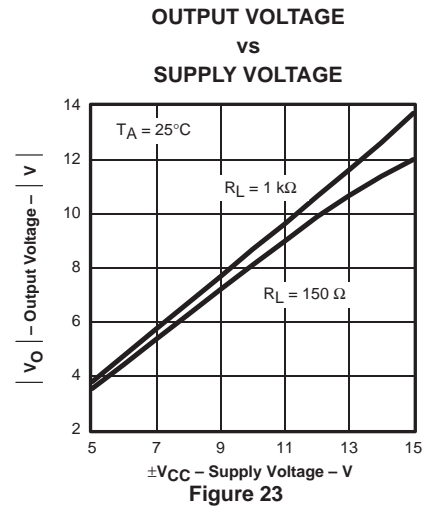

Figure 23

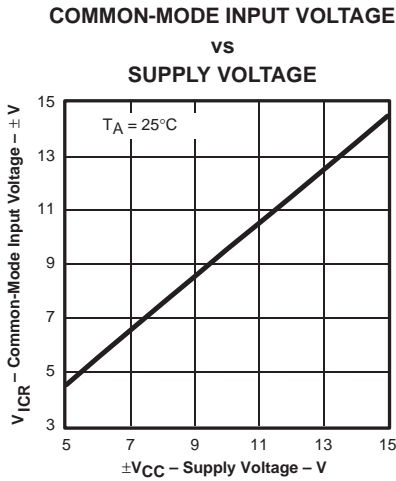

Figure 24

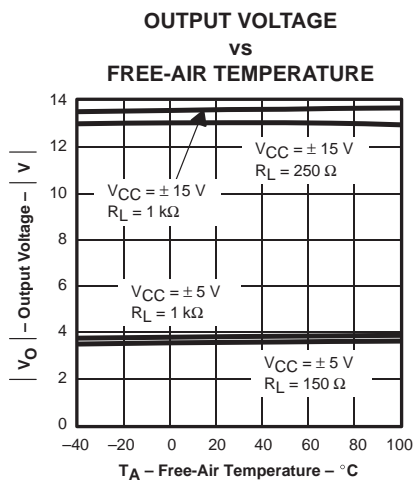

Figure 25

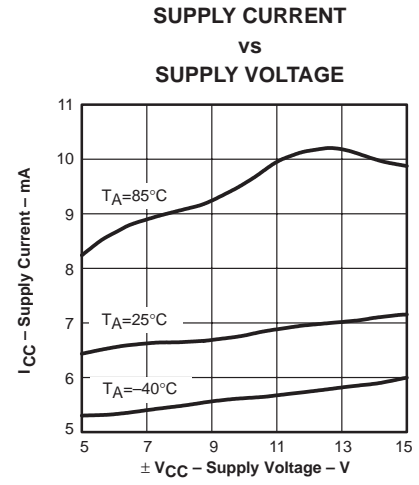

Figure 26

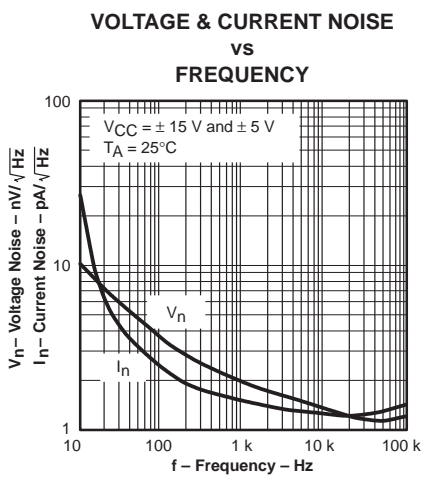

Figure 27

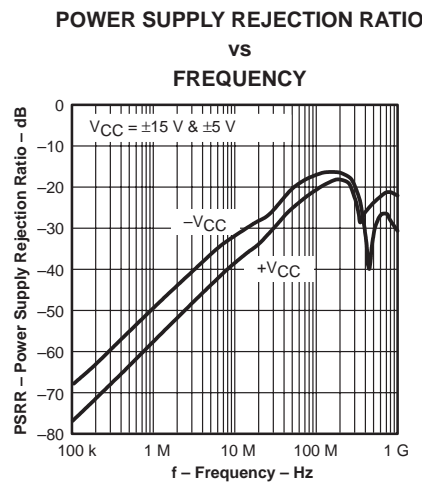

Figure 28

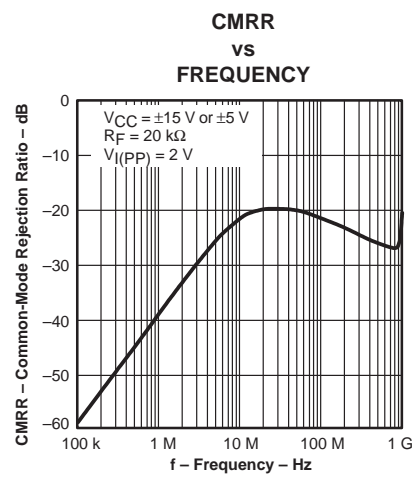

Figure 29



APPLICATION INFORMATION

theory of operation

The THS402x is a high-speed, operational amplifier configured in a voltage feedback architecture. It is built using a 30-V, dielectrically isolated, complementary bipolar process with NPN and PNP transistors possessing f_T s of several GHz. This results in an exceptionally high performance amplifier that has a wide bandwidth, high slew rate, fast settling time, and low distortion. A simplified schematic is shown in Figure 30.

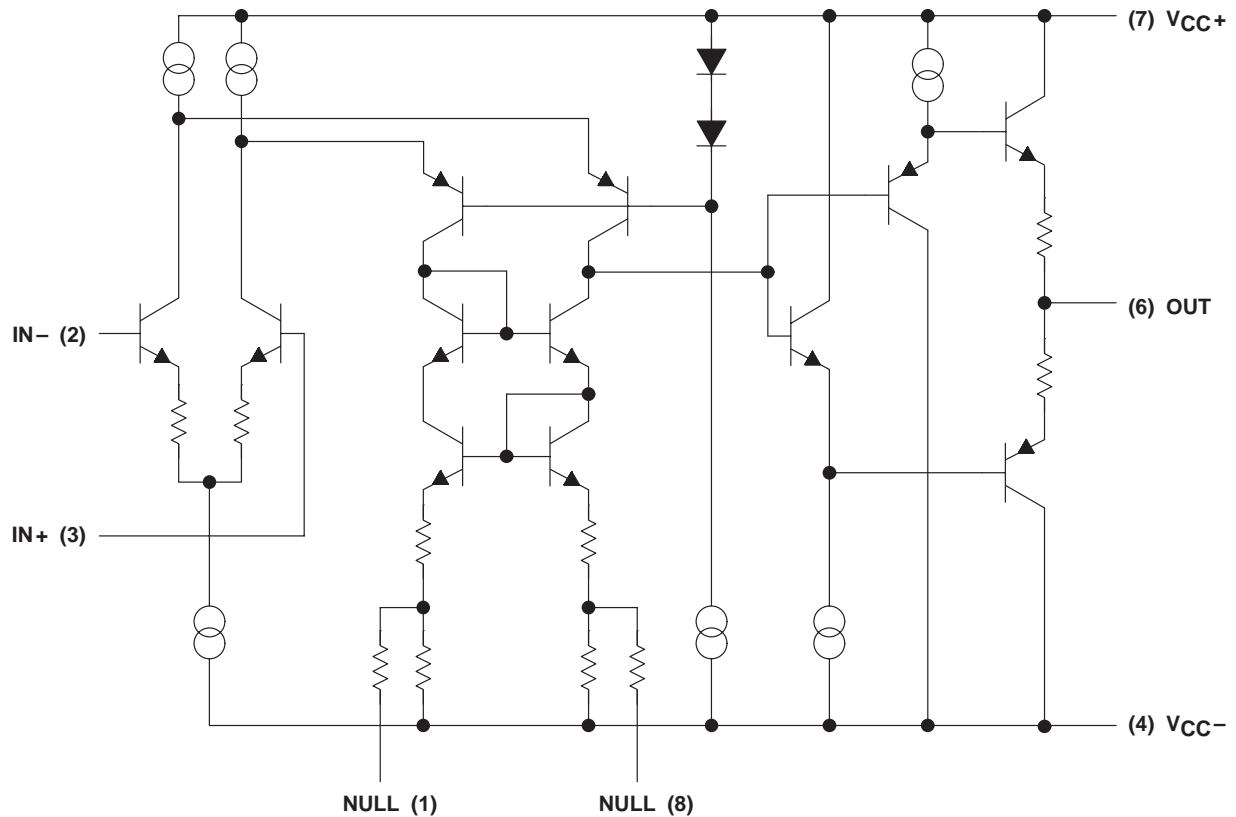

Figure 30. THS4021 Simplified Schematic

noise calculations and noise figure

Noise can cause errors on very small signals. This is especially true when amplifying small signals, where signal-to-noise ratio (SNR) is very important. The noise model for the THS402x is shown in Figure 31. This model includes all of the noise sources as follows:

- e_n = Amplifier internal voltage noise (nV/\sqrt{Hz})
- $IN+$ = Noninverting current noise (pA/\sqrt{Hz})
- $IN-$ = Inverting current noise (pA/\sqrt{Hz})
- e_{RX} = Thermal voltage noise associated with each resistor ($e_{RX} = 4 kTR_X$)

APPLICATION INFORMATION

noise calculations and noise figure (continued)

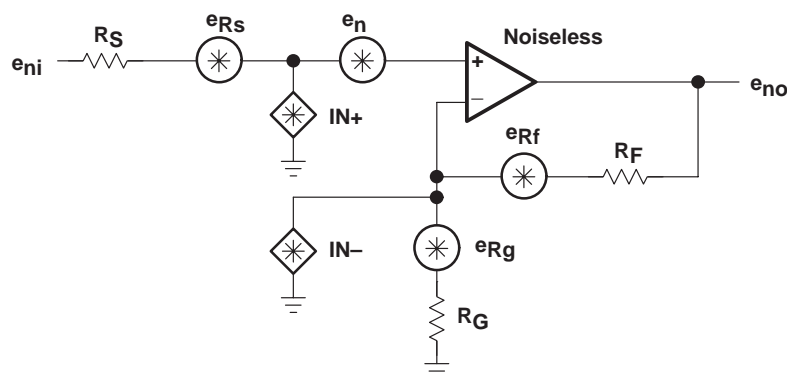

Figure 31. Noise Model

The total equivalent input noise density (e_{ni}) is calculated by using the following equation:

$$e_{ni} = \sqrt{(e_n)^2 + (IN+ \times R_S)^2 + (IN- \times (R_F \parallel R_G))^2 + 4 kTR_S + 4 kT(R_F \parallel R_G)}$$

Where:

k = Boltzmann's constant = 1.380658×10^{-23}

T = Temperature in degrees Kelvin ($273 + ^\circ\text{C}$)

$R_F \parallel R_G$ = Parallel resistance of R_F and R_G

To get the equivalent output noise of the amplifier, just multiply the equivalent input noise density (e_{ni}) by the overall amplifier gain (A_V).

$$e_{no} = e_{ni} A_V = e_{ni} \left(1 + \frac{R_F}{R_G} \right) \text{ (noninverting case)}$$

As the previous equations show, to keep noise at a minimum, small value resistors should be used. As the closed-loop gain is increased (by reducing R_G), the input noise is reduced considerably because of the parallel resistance term. This leads to the general conclusion that the most dominant noise sources are the source resistor (R_S) and the internal amplifier noise voltage (e_n). Because noise is summed in a root-mean-squares method, noise sources smaller than 25% of the largest noise source can be effectively ignored. This can greatly simplify the formula and make noise calculations much easier to calculate.

For more information on noise analysis, please refer to the *Noise Analysis* section in *Operational Amplifier Circuits Applications Report* (literature number SLVA043).

APPLICATION INFORMATION

noise calculations and noise figure (continued)

This brings up another noise measurement usually preferred in RF applications, the noise figure (NF). Noise figure is a measure of noise degradation caused by the amplifier. The value of the source resistance must be defined and is typically 50 Ω in RF applications.

$$NF = 10\log \left[\frac{e_{ni}^2}{(e_{Rs})^2} \right]$$

Because the dominant noise components are generally the source resistance and the internal amplifier noise voltage, we can approximate noise figure as:

$$NF = 10\log \left[1 + \frac{\left[(e_n)^2 + (IN + \times R_S)^2 \right]}{4 kTR_S} \right]$$

Figure 32 shows the noise figure graph for the THS402x.

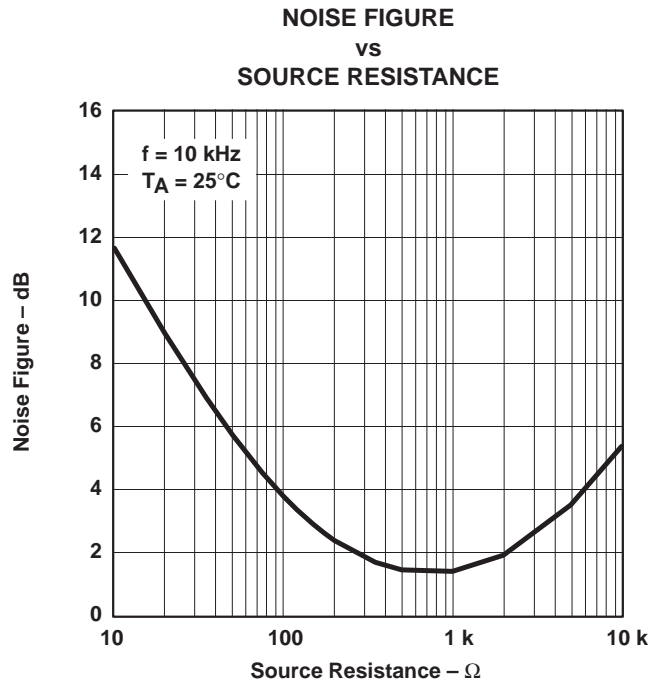

Figure 32. Noise Figure vs Source Resistance

THS4021, THS4022 350-MHz LOW-NOISE HIGH-SPEED AMPLIFIERS

SLOS265B – SEPTEMBER 1999 – REVISED FEBRUARY 2000

APPLICATION INFORMATION

driving a capacitive load

Driving capacitive loads with high performance amplifiers is not a problem as long as certain precautions are taken. The first is to realize that the THS402x has been internally compensated to maximize its bandwidth and slew rate performance. When the amplifier is compensated in this manner, capacitive loading directly on the output will decrease the device's phase margin leading to high frequency ringing or oscillations. Therefore, for capacitive loads of greater than 10 pF, it is recommended that a resistor be placed in series with the output of the amplifier, as shown in Figure 33. A minimum value of 20 Ω should work well for most applications. For example, in 75- Ω transmission systems, setting the series resistor value to 75 Ω both isolates any capacitance loading and provides the proper line impedance matching at the source end.

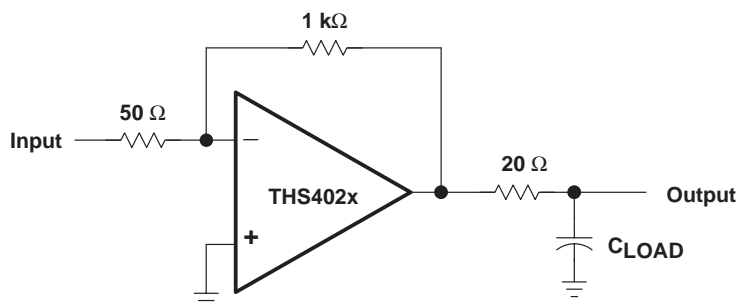

Figure 33. Driving a Capacitive Load

offset nulling

The THS402x has very low input offset voltage for a high-speed amplifier. However, if additional correction is required, an offset nulling function has been provided on the THS4021. The input offset can be adjusted by placing a potentiometer between terminals 1 and 8 of the device and tying the wiper to the negative supply. This is shown in Figure 34.

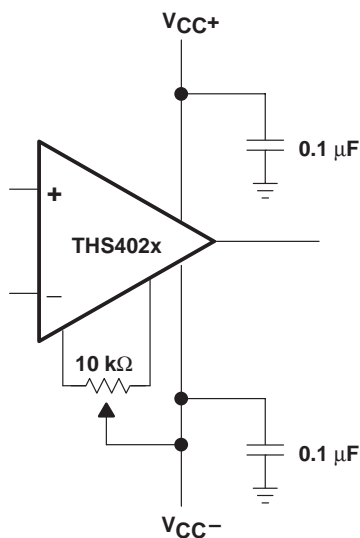

Figure 34. Offset Nulling Schematic

APPLICATION INFORMATION

offset voltage

The output offset voltage, (V_{OO}) is the sum of the input offset voltage (V_{IO}) and both input bias currents (I_{IB}) times the corresponding gains. The following schematic and formula can be used to calculate the output offset voltage:

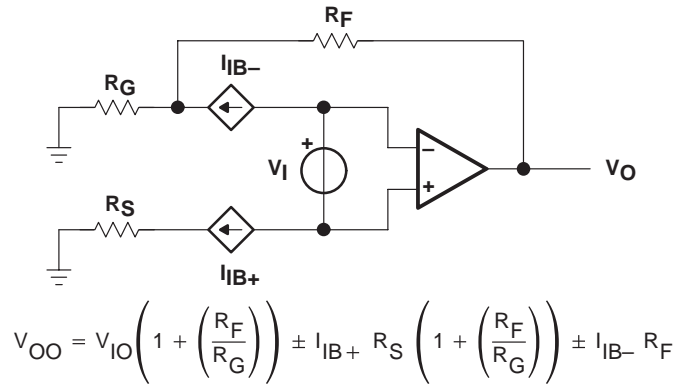

Figure 35. Output Offset Voltage Model

general configurations

When receiving low-level signals, limiting the bandwidth of the incoming signals into the system is often required. The simplest way to accomplish this is to place an RC filter at the noninverting terminal of the amplifier (see Figure 36).

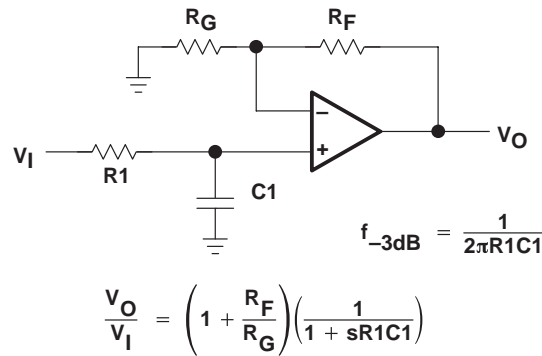

Figure 36. Single-Pole Low-Pass Filter

APPLICATION INFORMATION

circuit layout considerations

To achieve the levels of high frequency performance of the THS402x, follow proper printed-circuit board high frequency design techniques. A general set of guidelines is given below. In addition, a THS402x evaluation board is available to use as a guide for layout or for evaluating the device performance.

- Ground planes – It is highly recommended that a ground plane be used on the board to provide all components with a low inductive ground connection. However, in the areas of the amplifier inputs and output, the ground plane can be removed to minimize the stray capacitance.
- Proper power supply decoupling – Use a 6.8- μ F tantalum capacitor in parallel with a 0.1- μ F ceramic capacitor on each supply terminal. It may be possible to share the tantalum among several amplifiers depending on the application, but a 0.1- μ F ceramic capacitor should always be used on the supply terminal of every amplifier. In addition, the 0.1- μ F capacitor should be placed as close as possible to the supply terminal. As this distance increases, the inductance in the connecting trace makes the capacitor less effective. The designer should strive for distances of less than 0.1 inches between the device power terminals and the ceramic capacitors.
- Sockets – Sockets are not recommended for high-speed operational amplifiers. The additional lead inductance in the socket pins will often lead to stability problems. Surface-mount packages soldered directly to the printed-circuit board is the best implementation.
- Short trace runs/compact part placements – Optimum high frequency performance is achieved when stray series inductance has been minimized. To realize this, the circuit layout should be made as compact as possible, thereby minimizing the length of all trace runs. Particular attention should be paid to the inverting input of the amplifier. Its length should be kept as short as possible. This will help to minimize stray capacitance at the input of the amplifier.
- Surface-mount passive components – Using surface-mount passive components is recommended for high frequency amplifier circuits for several reasons. First, because of the extremely low lead inductance of surface-mount components, the problem with stray series inductance is greatly reduced. Second, the small size of surface-mount components naturally leads to a more compact layout, thereby minimizing both stray inductance and capacitance. If leaded components are used, it is recommended that the lead lengths be kept as short as possible.

general PowerPAD design considerations

The THS402x is available packaged in a thermally-enhanced DGN package, which is a member of the PowerPAD family of packages. This package is constructed using a downset leadframe upon which the die is mounted [see Figure 37(a) and Figure 37(b)]. This arrangement results in the lead frame being exposed as a thermal pad on the underside of the package [see Figure 37(c)]. Because this thermal pad has direct thermal contact with the die, excellent thermal performance can be achieved by providing a good thermal path away from the thermal pad.

The PowerPAD package allows for both assembly and thermal management in one manufacturing operation. During the surface-mount solder operation (when the leads are being soldered), the thermal pad can also be soldered to a copper area underneath the package. Through the use of thermal paths within this copper area, heat can be conducted away from the package into either a ground plane or other heat dissipating device.

The PowerPAD package represents a breakthrough in combining the small area and ease of assembly of the surface mount with the, heretofore, awkward mechanical methods of heatsinking.

APPLICATION INFORMATION

general PowerPAD design considerations (continued)

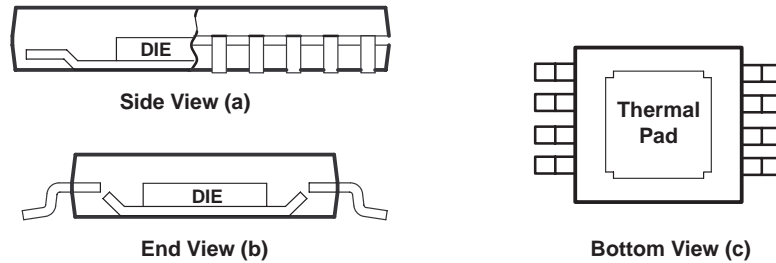

NOTE A: The thermal pad is electrically isolated from all terminals in the package.

Figure 37. Views of Thermally Enhanced DGN Package

Although there are many ways to properly heatsink this device, the following steps illustrate the recommended approach.

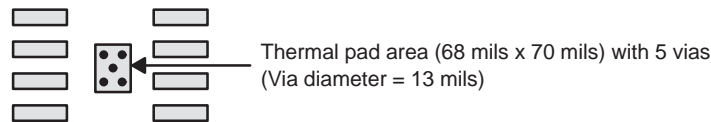

Figure 38. PowerPAD PCB Etch and Via Pattern

1. Prepare the PCB with a top side etch pattern as shown in Figure 38. There should be etch for the leads as well as etch for the thermal pad.
2. Place five holes in the area of the thermal pad. These holes should be 13 mils in diameter. Keep them small so that solder wicking through the holes is not a problem during reflow.
3. Additional vias may be placed anywhere along the thermal plane outside of the thermal pad area. This helps dissipate the heat generated by the THS402xDGN IC. These additional vias may be larger than the 13-mil diameter vias directly under the thermal pad. They can be larger because they are not in the thermal pad area to be soldered, so wicking is not a problem.
4. Connect all holes to the internal ground plane.
5. When connecting these holes to the ground plane, do not use the typical web or spoke via connection methodology. Web connections have a high thermal resistance connection that is useful for slowing the heat transfer during soldering operations. This makes the soldering of vias that have plane connections easier. In this application, however, low thermal resistance is desired for the most efficient heat transfer. Therefore, the holes under the THS402xDGN package should make their connection to the internal ground plane with a complete connection around the entire circumference of the plated-through hole.
6. The top-side solder mask should leave the terminals of the package and the thermal pad area with its five holes exposed. The bottom-side solder mask should cover the five holes of the thermal pad area. This prevents solder from being pulled away from the thermal pad area during the reflow process.
7. Apply solder paste to the exposed thermal pad area and all of the IC terminals.
8. With these preparatory steps in place, the THS402xDGN IC is simply placed in position and run through the solder reflow operation as any standard surface-mount component. This results in a part that is properly installed.

APPLICATION INFORMATION

general PowerPAD design considerations (continued)

The actual thermal performance achieved with the THS402xDGN in its PowerPAD package depends on the application. In the example above, if the size of the internal ground plane is approximately 3 inches × 3 inches, then the expected thermal coefficient, θ_{JA} , is about 58.4°C/W. For comparison, the non-PowerPAD version of the THS402x IC (SOIC) is shown. For a given θ_{JA} , the maximum power dissipation is shown in Figure 39 and is calculated by the following formula:

$$P_D = \left(\frac{T_{MAX} - T_A}{\theta_{JA}} \right)$$

Where:

- P_D = Maximum power dissipation of THS402x IC (watts)
- T_{MAX} = Absolute maximum junction temperature (150°C)
- T_A = Free-ambient air temperature (°C)
- θ_{JA} = $\theta_{JC} + \theta_{CA}$
- θ_{JC} = Thermal coefficient from junction to case
- θ_{CA} = Thermal coefficient from case to ambient air (°C/W)

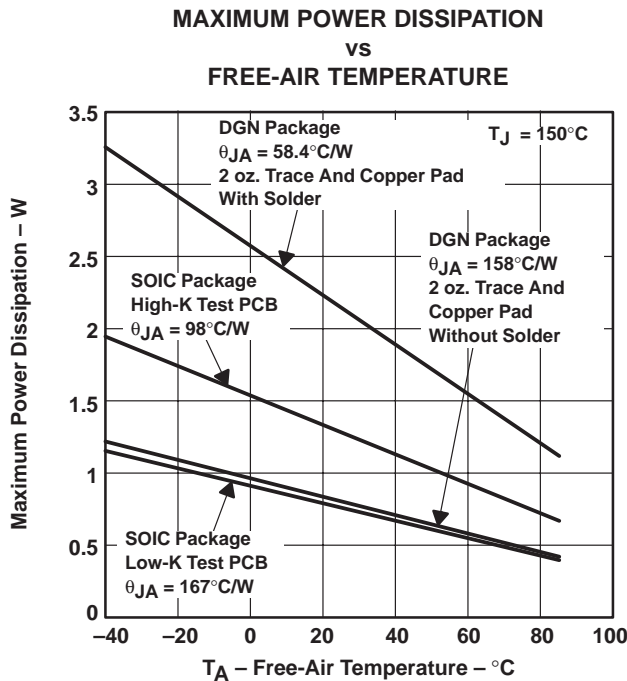

NOTE A: Results are with no air flow and PCB size = 3"× 3"

Figure 39. Maximum Power Dissipation vs Free-Air Temperature

More complete details of the PowerPAD installation process and thermal management techniques can be found in the Texas Instruments Technical Brief, *PowerPAD Thermally Enhanced Package*. This document can be found at the TI web site (www.ti.com) by searching on the key word PowerPAD. The document can also be ordered through your local TI sales office. Refer to literature number SLMA002 when ordering.

APPLICATION INFORMATION

general PowerPAD design considerations (continued)

The next consideration is the package constraints. The two sources of heat within an amplifier are quiescent power and output power. The designer should never forget about the quiescent heat generated within the device, especially multi-amplifier devices. Because these devices have linear output stages (Class A-B), most of the heat dissipation is at low output voltages with high output currents. Figure 40 to Figure 43 show this effect, along with the quiescent heat, with an ambient air temperature of 50°C. Obviously, as the ambient temperature increases, the limit lines shown will drop accordingly. The area under each respective limit line is considered the safe operating area. Any condition above this line will exceed the amplifier's limits and failure may result. When using $V_{CC} = \pm 5\text{ V}$, there is generally not a heat problem, even with SOIC packages. But, when using $V_{CC} = \pm 15\text{ V}$, the SOIC package is severely limited in the amount of heat it can dissipate. The other key factor when looking at these graphs is how the devices are mounted on the PCB. The PowerPAD devices are extremely useful for heat dissipation. But, the device should always be soldered to a copper plane to fully use the heat dissipation properties of the PowerPAD. The SOIC package, on the other hand, is highly dependent on how it is mounted on the PCB. As more trace and copper area is placed around the device, θ_{JA} decreases and the heat dissipation capability increases. The currents and voltages shown in these graphs are for the total package. For the dual amplifier package (THS4022), the sum of the RMS output currents and voltages should be used to choose the proper package. The graphs shown assume that both amplifier's outputs are identical.

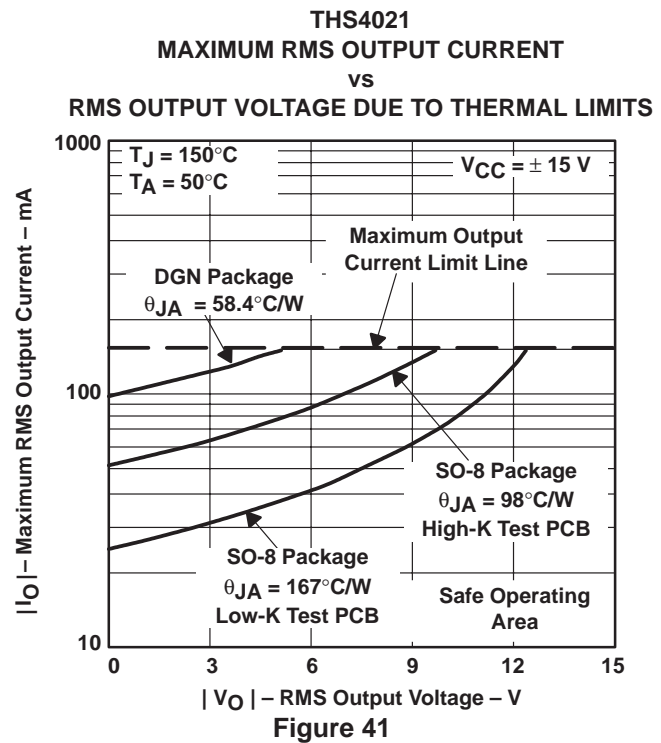
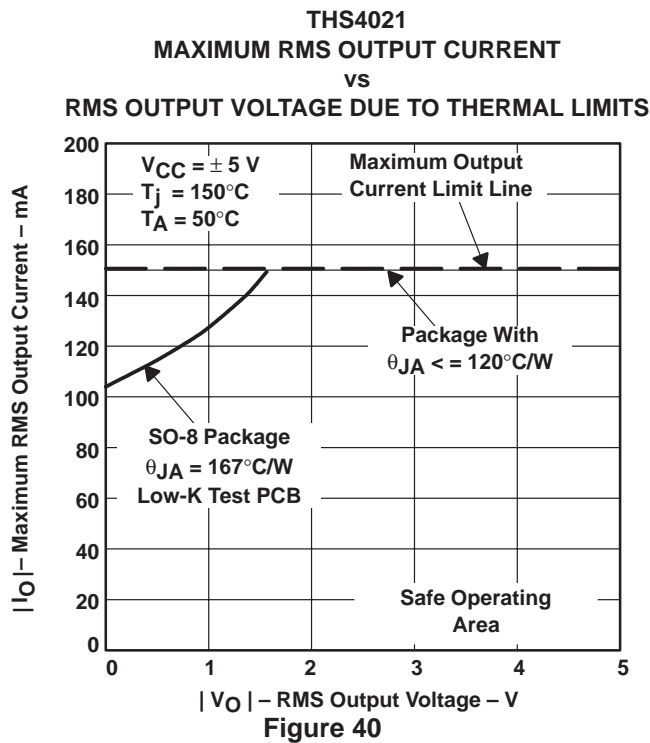

THS4021, THS4022 350-MHz LOW-NOISE HIGH-SPEED AMPLIFIERS

SLOS265B – SEPTEMBER 1999 – REVISED FEBRUARY 2000

APPLICATION INFORMATION

general PowerPAD design considerations (continued)

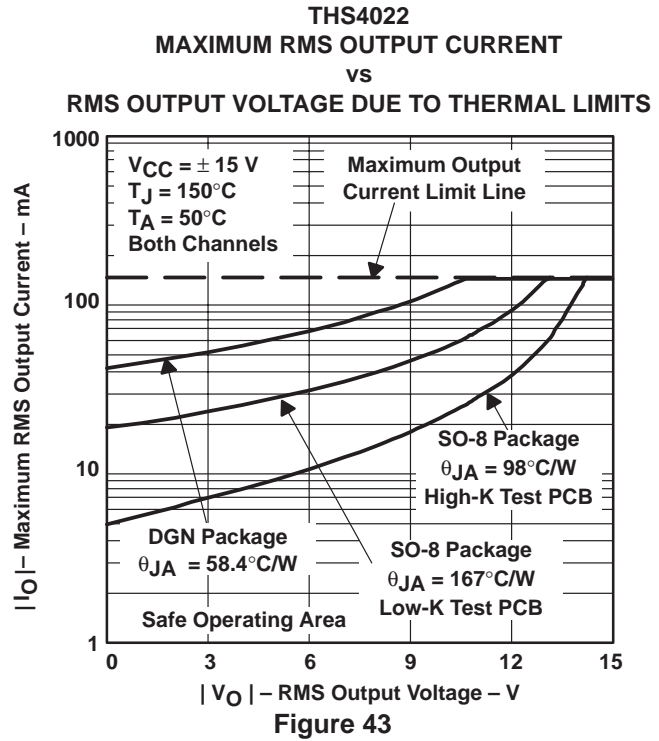
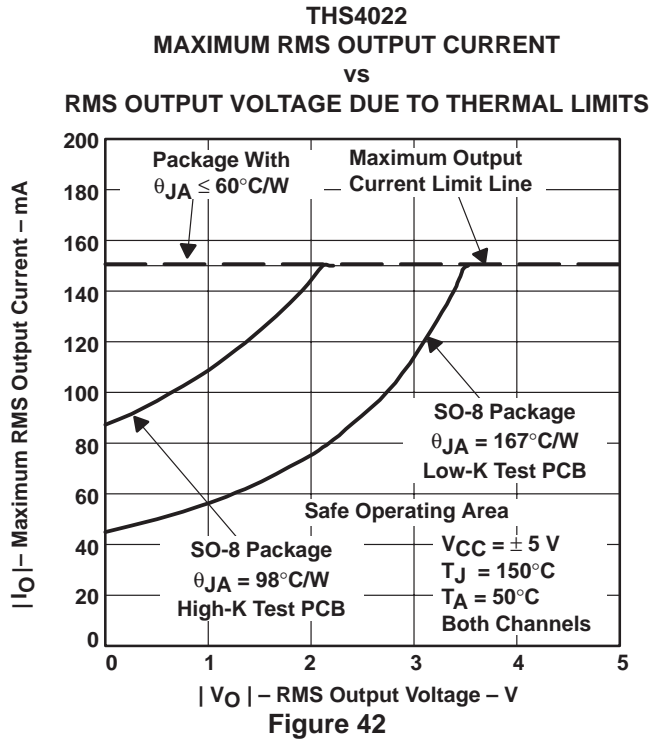

APPLICATION INFORMATION

evaluation board

An evaluation board is available for the THS4021 (literature number SLOP129) and THS4022 (literature number SLOP231). This board has been configured for very low parasitic capacitance in order to realize the full performance of the amplifier. A schematic of the evaluation board is shown in Figure 44. The circuitry has been designed so that the amplifier may be used in either an inverting or noninverting configuration. For more information, please refer to the *THS4021 EVM User's Guide* or the *THS4022 EVM User's Guide*. To order the evaluation board, contact your local TI sales office or distributor.

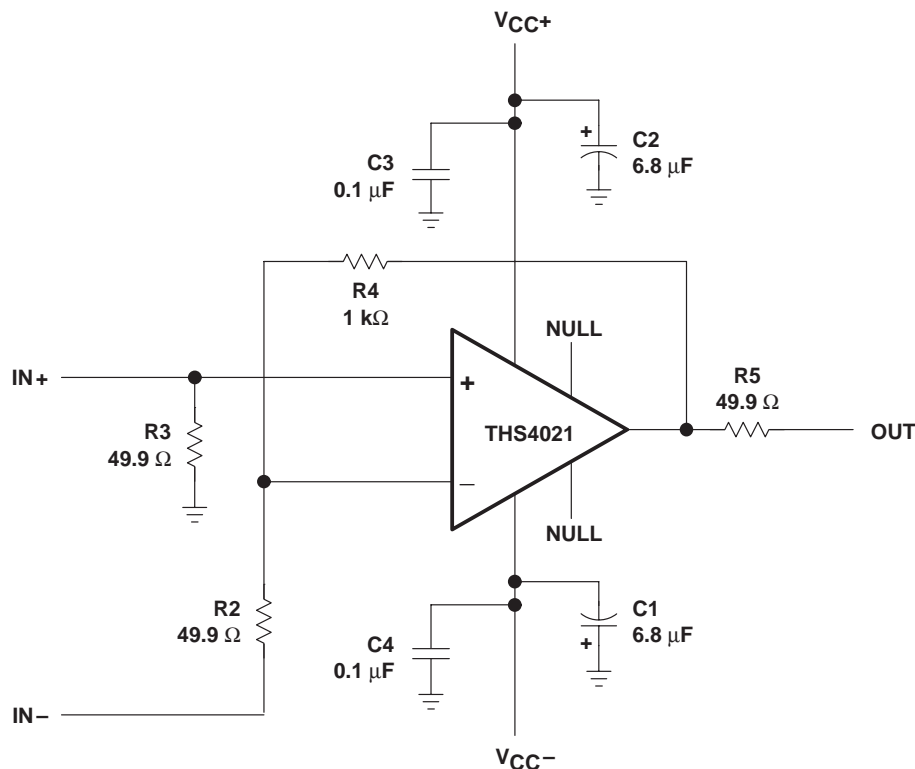

Figure 44. THS4021 Evaluation Board

THS4021, THS4022 350-MHz LOW-NOISE HIGH-SPEED AMPLIFIERS

SLOS265B – SEPTEMBER 1999 – REVISED FEBRUARY 2000

MECHANICAL INFORMATION

D (R-PDSO-G**)

PLASTIC SMALL-OUTLINE PACKAGE

14 PIN SHOWN

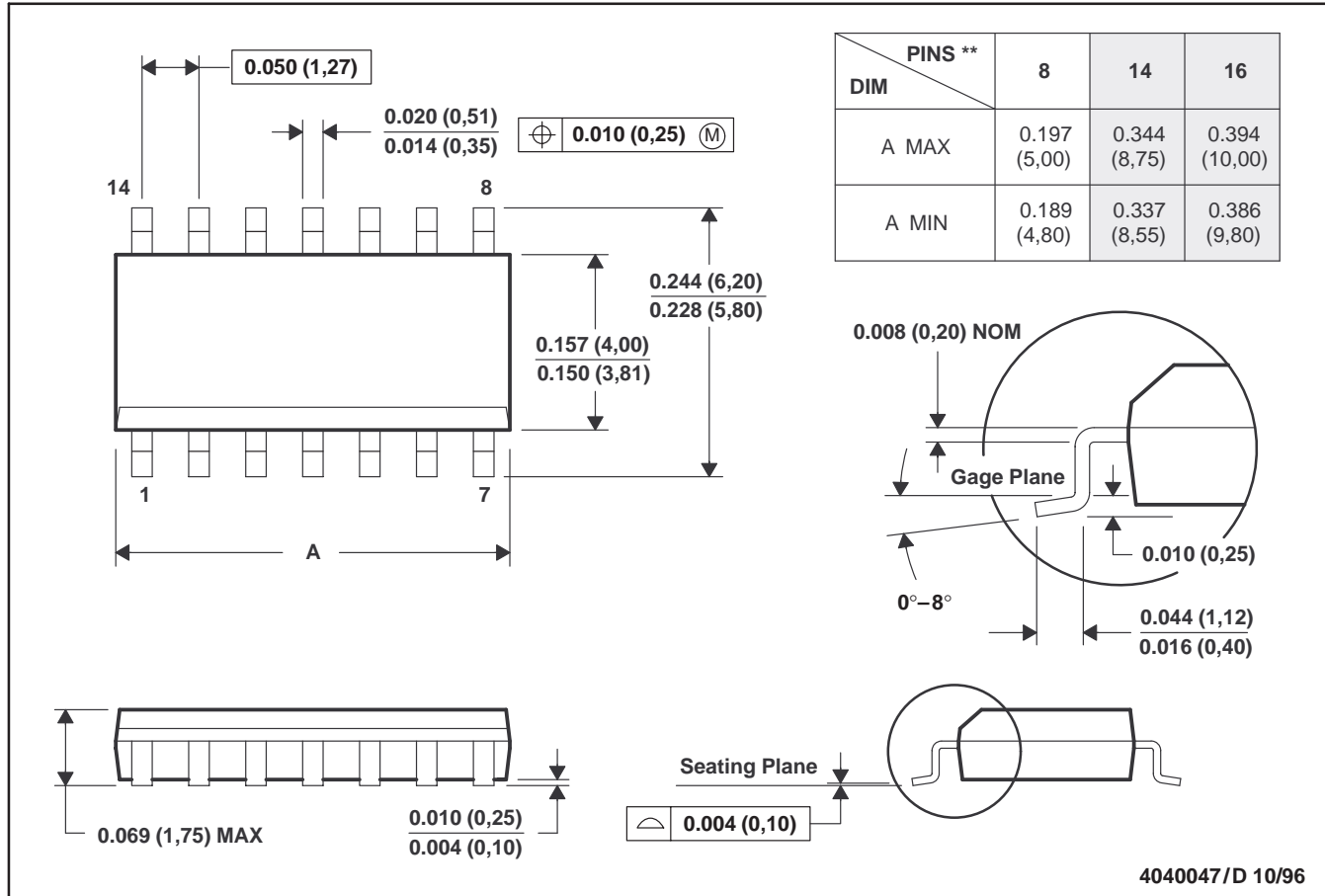

- NOTES: A. All linear dimensions are in inches (millimeters).
 B. This drawing is subject to change without notice.
 C. Body dimensions do not include mold flash or protrusion, not to exceed 0.006 (0,15).
 D. Falls within JEDEC MS-012

MECHANICAL INFORMATION

DGN (S-PDSO-G8)

PowerPAD™ PLASTIC SMALL-OUTLINE PACKAGE

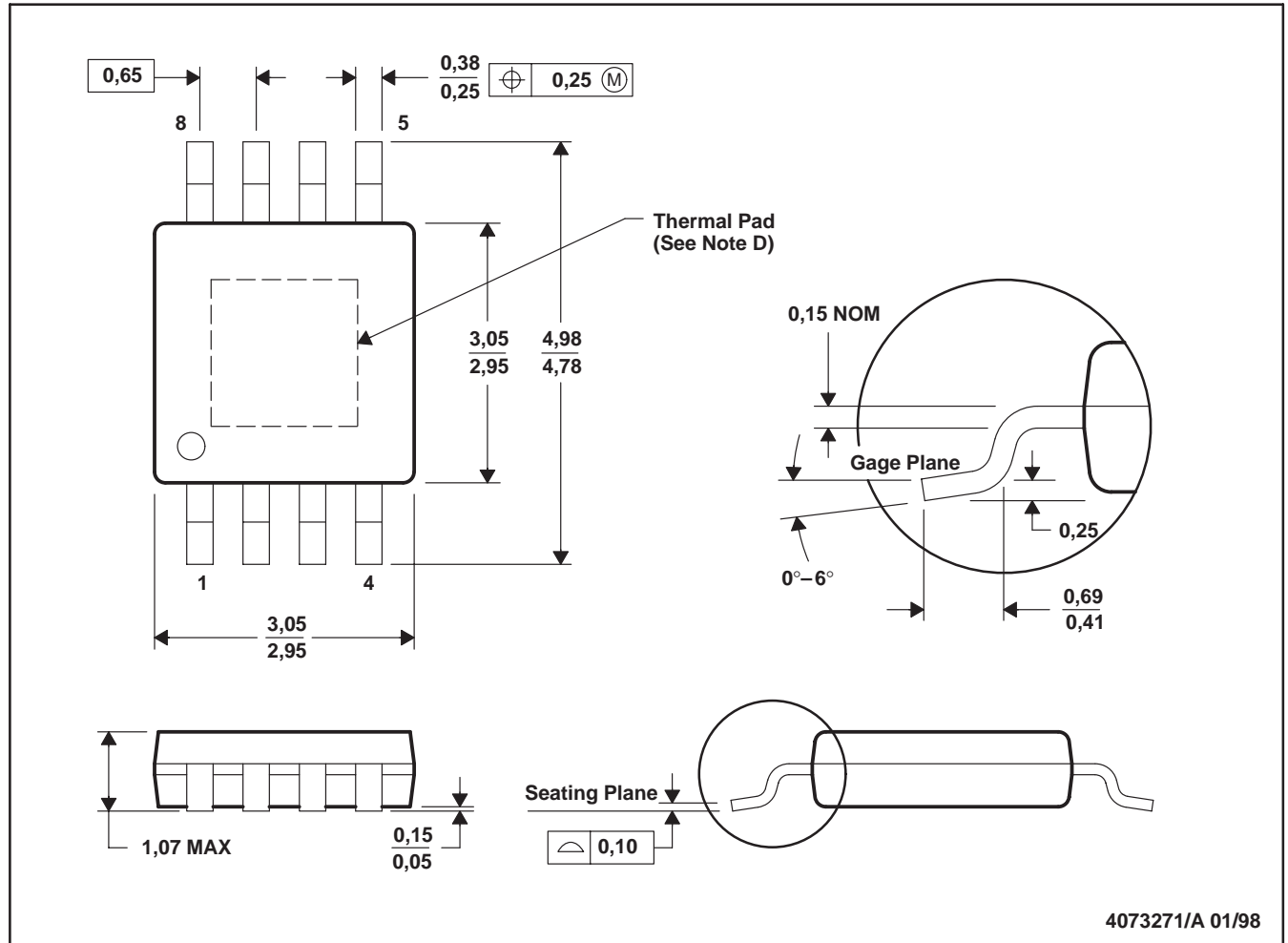

- NOTES:
- A. All linear dimensions are in millimeters.
 - B. This drawing is subject to change without notice.
 - C. Body dimensions include mold flash or protrusions.
 - D. The package thermal performance may be enhanced by attaching an external heat sink to the thermal pad. This pad is electrically and thermally connected to the backside of the die and possibly selected leads.
 - E. Falls within JEDEC MO-187

PowerPAD is a trademark of Texas Instruments Incorporated.

IMPORTANT NOTICE

Texas Instruments and its subsidiaries (TI) reserve the right to make changes to their products or to discontinue any product or service without notice, and advise customers to obtain the latest version of relevant information to verify, before placing orders, that information being relied on is current and complete. All products are sold subject to the terms and conditions of sale supplied at the time of order acknowledgement, including those pertaining to warranty, patent infringement, and limitation of liability.

TI warrants performance of its semiconductor products to the specifications applicable at the time of sale in accordance with TI's standard warranty. Testing and other quality control techniques are utilized to the extent TI deems necessary to support this warranty. Specific testing of all parameters of each device is not necessarily performed, except those mandated by government requirements.

CERTAIN APPLICATIONS USING SEMICONDUCTOR PRODUCTS MAY INVOLVE POTENTIAL RISKS OF DEATH, PERSONAL INJURY, OR SEVERE PROPERTY OR ENVIRONMENTAL DAMAGE ("CRITICAL APPLICATIONS"). TI SEMICONDUCTOR PRODUCTS ARE NOT DESIGNED, AUTHORIZED, OR WARRANTED TO BE SUITABLE FOR USE IN LIFE-SUPPORT DEVICES OR SYSTEMS OR OTHER CRITICAL APPLICATIONS. INCLUSION OF TI PRODUCTS IN SUCH APPLICATIONS IS UNDERSTOOD TO BE FULLY AT THE CUSTOMER'S RISK.

In order to minimize risks associated with the customer's applications, adequate design and operating safeguards must be provided by the customer to minimize inherent or procedural hazards.

TI assumes no liability for applications assistance or customer product design. TI does not warrant or represent that any license, either express or implied, is granted under any patent right, copyright, mask work right, or other intellectual property right of TI covering or relating to any combination, machine, or process in which such semiconductor products or services might be or are used. TI's publication of information regarding any third party's products or services does not constitute TI's approval, warranty or endorsement thereof.