

# TLV4110, TLV4111, TLV4112, TLV4113 FAMILY OF HIGH OUTPUT DRIVE OPERATIONAL AMPLIFIERS WITH SHUTDOWN

SLOS289E – DECEMBER 1999 – REVISED SEPTEMBER 2006

- High Output Drive . . . >300 mA
- Rail-To-Rail Output
- Unity-Gain Bandwidth . . . 2.7 MHz
- Slew Rate . . . 1.5 V/ $\mu$ s
- Supply Current . . . 700  $\mu$ A/Per Channel
- Supply Voltage Range . . . 2.5 V to 6 V
- Specified Temperature Range:
  - $T_A = 0^\circ\text{C}$  to  $70^\circ\text{C}$  . . . Commercial Grade
  - $T_A = -40^\circ\text{C}$  to  $125^\circ\text{C}$  . . . Industrial Grade
- Universal OpAmp EVM

Operational Amplifier

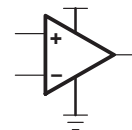

TLV4112  
D, DGN, OR P PACKAGE  
(TOP VIEW)

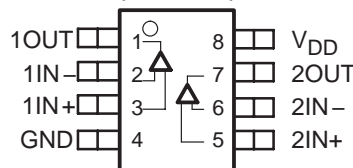

## description

The TLV411x single supply operational amplifiers provide output currents in excess of 300 mA at 5 V. This enables standard pin-out amplifiers to be used as high current buffers or in coil driver applications. The TLV4110 and TLV4113 come with a shutdown feature.

The TLV411x is available in the ultra small MSOP PowerPAD™ package, which offers the exceptional thermal impedance required for amplifiers delivering high current levels.

All TLV411x devices are offered in PDIP, SOIC (single and dual) and MSOP PowerPAD (dual).

FAMILY PACKAGE TABLE

DEVICE	NUMBER OF CHANNELS	PACKAGE TYPES			SHUTDOWN	UNIVERSAL EVM BOARD
		MSOP	PDIP	SOIC		
TLV4110	1	8	8	8	Yes	Refer to the EVM Selection Guide (Lit# SLOU060)
TLV4111	1	8	8	8	—	
TLV4112	2	8	8	8	—	
TLV4113	2	10	14	14	Yes	

HIGH-LEVEL OUTPUT VOLTAGE  
vs  
HIGH-LEVEL OUTPUT CURRENT

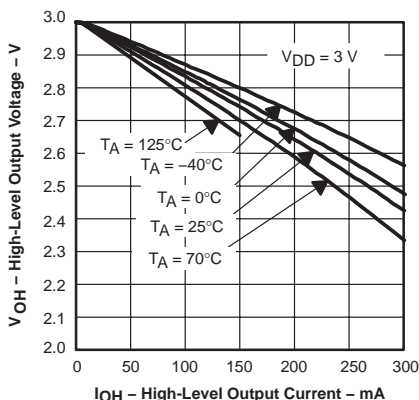

LOW-LEVEL OUTPUT VOLTAGE  
vs  
LOW-LEVEL OUTPUT CURRENT

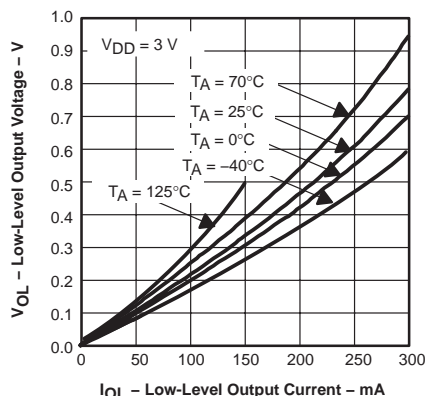

Please be aware that an important notice concerning availability, standard warranty, and use in critical applications of Texas Instruments semiconductor products and disclaimers thereto appears at the end of this data sheet.

PowerPAD is a trademark of Texas Instruments. All other trademarks are the property of their respective owners.

PRODUCTION DATA information is current as of publication date. Products conform to specifications per the terms of Texas Instruments standard warranty. Production processing does not necessarily include testing of all parameters.



POST OFFICE BOX 655303 • DALLAS, TEXAS 75265

Copyright © 1999–2006, Texas Instruments Incorporated

# TLV4110, TLV4111, TLV4112, TLV4113 FAMILY OF HIGH OUTPUT DRIVE OPERATIONAL AMPLIFIERS WITH SHUTDOWN

SLOS289E – DECEMBER 1999 – REVISED SEPTEMBER 2006

## TLV4110 AND TLV4111 AVAILABLE OPTIONS

T <sub>A</sub>	PACKAGED DEVICES			
	SMALL OUTLINE (D)†‡	MSOP		PLASTIC DIP (P)
		SMALL OUTLINE (DGN)†	SYMBOL	
0°C to 70°C	TLV4110CD	TLV4110CDGN	xxTIAHL	TLV4110CP
	TLV4111CD	TLV4111CDGN	xxTIAHN	TLV4111CP
-40°C to 125°C	TLV4110ID	TLV4110IDGN	xxTIAHM	TLV4110IP
	TLV4111ID	TLV4111IDGN	xxTIAHO	TLV4111IP

† This package is available taped and reeled. To order this packaging option, add an R suffix to the part number (e.g., TLV4110CDR).

‡ In the SOIC package, the maximum RMS output power is thermally limited to 350 mW; 700 mW peaks can be driven, as long as the RMS value is less than 350 mW.

## TLV4112 AND TLV4113 AVAILABLE OPTIONS

T <sub>A</sub>	PACKAGED DEVICES					
	SMALL OUTLINE (D)†‡	MSOP				PLASTIC DIP (P)
		SMALL OUTLINE (DGN)†	SYMBOL	SMALL OUTLINE (DGQ)†	SYMBOL	
0°C to 70°C	TLV4112CD	TLV4112DGN	xxTIAHP	—	—	TLV4112CP
	TLV4113CD	—	—	TLV4113CDGQ	xxTIAHR	TLV4113CN
-40°C to 125°C	TLV4112ID	TLV4112IDGN	xxTIAHQ	—	—	TLV4112IP
	TLV4113ID	—	—	TLV4113IDGQ	xxTIAHS	TLV4113IN

† This package is available taped and reeled. To order this packaging option, add an R suffix to the part number (e.g., TLV4112CDR).

‡ In the SOIC package, the maximum RMS output power is thermally limited to 350 mW; 700 mW peaks can be driven, as long as the RMS value is less than 350 mW.

## TLV411x PACKAGE PIN OUTS

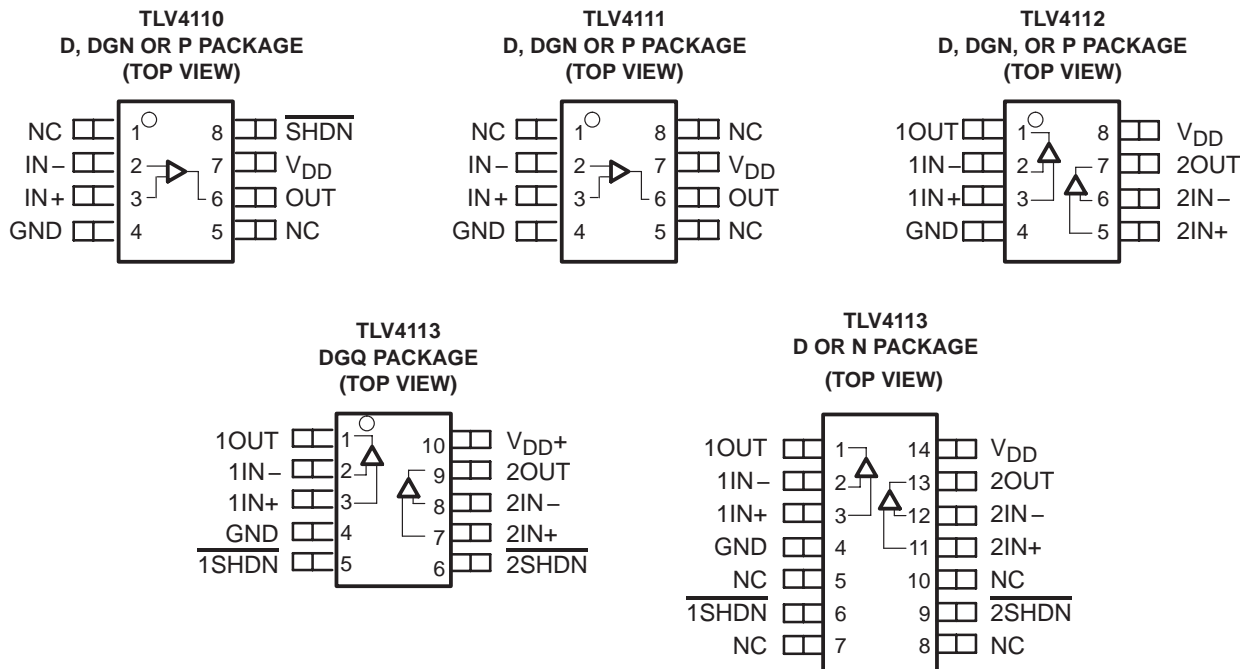

NC – No internal connection



# TLV4110, TLV4111, TLV4112, TLV4113 FAMILY OF HIGH OUTPUT DRIVE OPERATIONAL AMPLIFIERS WITH SHUTDOWN

SLOS289E – DECEMBER 1999 – REVISED SEPTEMBER 2006

## absolute maximum ratings over operating free-air temperature range (unless otherwise noted)†

Supply voltage, $V_{DD}$ (see Note 1)	7 V
Differential input voltage, $V_{ID}$	$\pm V_{DD}$
Input voltage range, $V_I$	$\pm V_{DD}$
Output current, $I_O$ (see Note 2)	800 mA
Continuous /RMS output current, $I_O$ (each output of amplifier):	
$T_J \leq 105^\circ\text{C}$	350 mA
$T_J \leq 150^\circ\text{C}$	110 mA
Peak output current, $I_O$ (each output of amplifier):	
$T_J \leq 105^\circ\text{C}$	500 mA
$T_J \leq 150^\circ\text{C}$	155 mA
Continuous total power dissipation	See Dissipation Rating Table
Operating free-air temperature range, $T_A$ :	
C suffix	0°C to 70°C
I suffix	–40°C to 125°C
Maximum junction temperature, $T_J$	150°C
Storage temperature range, $T_{stg}$	–65°C to 150°C
Lead temperature 1,6 mm (1/16 inch) from case for 10 seconds	260°C

† Stresses beyond those listed under “absolute maximum ratings” may cause permanent damage to the device. These are stress ratings only, and functional operation of the device at these or any other conditions beyond those indicated under “recommended operating conditions” is not implied. Exposure to absolute-maximum-rated conditions for extended periods may affect device reliability.

- NOTES: 1. All voltage values, except differential voltages, are with respect to GND.  
2. To prevent permanent damage the die temperature must not exceed the maximum junction temperature.

**DISSIPATION RATING TABLE**

PACKAGE	$\theta_{JC}$ (°C/W)	$\theta_{JA}$ (°C/W)	$T_A \leq 25^\circ\text{C}$ POWER RATING	$T_A = 125^\circ\text{C}$ POWER RATING
D (8)	38.3	176	710 mW	142 mW
D (14)	26.9	122.3	1022 mW	204.4 mW
DGN (8)‡	4.7	52.7	2.37 W	474.4 mW
DGQ (10)‡	4.7	52.3	2.39 W	478 mW
P (8)	41	104	1200 mW	240.4 mW
N (14)	32	78	1600 mW	320.5 mW

‡ See The Texas Instruments document, *PowerPAD Thermally Enhanced Package Application Report* (literature number SLMA002), for more information on the PowerPAD package. The thermal data was measured on a PCB layout based on the information in the section entitled *Texas Instruments Recommended Board for PowerPAD* on page 33 of the before mentioned document.

## recommended operating conditions

		MIN	MAX	UNIT
Supply voltage, $V_{DD}$		2.5	6	V
Common-mode input voltage range, $V_{ICR}$		0	$V_{DD}-1.5$	V
Operating free-air temperature, $T_A$	C-suffix	0	70	°C
	I-suffix	–40	125	
Shutdown turn-on/off voltage level§	V(on)	$V_{DD} = 3\text{ V}$	2.1	V
		$V_{DD} = 5\text{ V}$	3.8	
	V(off)	$V_{DD} = 3\text{ V}$	0.9	
		$V_{DD} = 5\text{ V}$	1.65	

§ Relative to GND



# TLV4110, TLV4111, TLV4112, TLV4113 FAMILY OF HIGH OUTPUT DRIVE OPERATIONAL AMPLIFIERS WITH SHUTDOWN

SLOS289E – DECEMBER 1999 – REVISED SEPTEMBER 2006

electrical characteristics at recommend operating conditions,  $V_{DD} = 3\text{ V}$  and  $5\text{ V}$  (unless otherwise noted)

## dc performance

PARAMETER		TEST CONDITIONS		$T_A^\dagger$	MIN	TYP	MAX	UNITS
$V_{IO}$	Input offset voltage	$V_{IC} = V_{DD}/2,$ $R_L = 100\ \Omega,$	$V_O = V_{DD}/2,$ $R_S = 50\ \Omega$	25°C	175	3500		$\mu\text{V}$
				Full range		4000		
$\alpha_{VIO}$	Offset voltage draft			25°C		3		$\mu\text{V}/^\circ\text{C}$
CMRR	Common-mode rejection ratio	$V_{DD} = 3\text{ V},$ $R_S = 50\ \Omega$	$V_{IC} = 0\text{ to }2\text{ V},$	25°C		63		dB
			$V_{IC} = 0\text{ to }4\text{ V},$	25°C		68		
$A_{VD}$	Large-signal differential voltage amplification	$V_{DD} = 3\text{ V},$ $V_{O(PP)} = 0\text{ to }1\text{ V}$	$R_L = 100\ \Omega$	25°C	78	84		dB
				Full range		67		
			$R_L = 10\ \text{k}\Omega$	25°C	85	100		
		Full range			75			
		$V_{DD} = 5\text{ V},$ $V_{O(PP)} = 0\text{ to }3\text{ V}$	$R_L = 100\ \Omega$	25°C	88	94		
				Full range		75		
$R_L = 10\ \text{k}\Omega$	25°C		90	110				
	Full range		85					

$^\dagger$  Full range is 0°C to 70°C for C suffix and -40°C to 125°C for I suffix. If not specified, full range is -40°C to 125°C.

## input characteristics

PARAMETER		TEST CONDITIONS		$T_A^\dagger$	MIN	TYP	MAX	UNITS
$I_{IO}$	Input offset current	$V_{IC} = V_{DD}/2$	TLV411xC	25°C	0.3	25		pA
				Full range		50		
			TLV411xI	Full range		250		
$I_{IB}$	Input bias current	$V_O = V_{DD}/2,$ $R_S = 50\ \Omega$	TLV411xC	25°C	0.3	50		pA
				Full range		100		
			TLV411xI	Full range		500		
$r_{i(d)}$	Differential input resistance			25°C		1000		$\text{G}\Omega$
$C_{IC}$	Common-mode input capacitance	$f = 100\ \text{Hz}$		25°C		5		pF

$^\dagger$  Full range is 0°C to 70°C for C suffix and -40°C to 125°C for I suffix. If not specified, full range is -40°C to 125°C.

# TLV4110, TLV4111, TLV4112, TLV4113 FAMILY OF HIGH OUTPUT DRIVE OPERATIONAL AMPLIFIERS WITH SHUTDOWN

SLOS289E – DECEMBER 1999 – REVISED SEPTEMBER 2006

electrical characteristics at specified free-air temperature,  $V_{DD} = 3\text{ V}$  and  $5\text{ V}$  (unless otherwise noted) (continued)

### output characteristics

PARAMETER	TEST CONDITIONS	$T_A$ †	MIN	TYP	MAX	UNITS
$V_{OH}$ High-level output voltage	$V_{DD} = 3\text{ V}$ , $V_{IC} = V_{DD}/2$	$I_{OH} = -10\text{ mA}$	25°C	2.7	2.97	V
			Full range	2.7		
		$I_{OH} = -100\text{ mA}$	25°C	2.6	2.73	
			Full range	2.6		
	$V_{DD} = 5\text{ V}$ , $V_{IC} = V_{DD}/2$	$I_{OH} = -10\text{ mA}$	25°C	4.7	4.96	V
			Full range	4.7		
		$I_{OH} = -100\text{ mA}$	25°C	4.6	4.76	
			Full range	4.6		
$V_{OL}$ Low-level output voltage	$V_{DD} = 3\text{ V}$ and $5\text{ V}$ , $V_{IC} = V_{DD}/2$	$I_{OL} = 10\text{ mA}$	25°C	0.03	0.1	V
			Full range		0.1	
		$I_{OL} = 100\text{ mA}$	25°C	0.33	0.4	
			Full range		0.55	
	$V_{DD} = 5\text{ V}$ , $V_{IC} = V_{DD}/2$	$I_{OL} = 200\text{ mA}$	25°C	0.38	0.6	
			-40°C to 85°C		0.7	
$I_O$ Output current‡	Measured at 0.5 V from rail	$V_{DD} = 3\text{ V}$	25°C	±220		mA
		$V_{DD} = 5\text{ V}$		±320		
$I_{OS}$ Short-circuit output current‡	Sourcing	25°C	800		mA	
	Sinking		800			

† Full range is 0°C to 70°C for C suffix and -40°C to 125°C for I suffix. If not specified, full range is -40°C to 125°C.

‡ When driving output currents in excess of 200 mA, the MSOP PowerPAD package is required for thermal dissipation.

### power supply

PARAMETER	TEST CONDITIONS	$T_A$	MIN	TYP	MAX	UNITS
$I_{DD}$ Supply current (per channel)	$V_O = V_{DD}/2$	25°C	700	1000	μA	
		Full range		1500		
PSRR Power supply rejection ratio ( $\Delta V_{DD} / \Delta V_{IO}$ )	$V_{DD} = 2.7\text{ to }3.3\text{ V}$ , No load, $V_{IC} = V_{DD}/2\text{ V}$	25°C	70	82	dB	
		Full range	65			
	$V_{DD} = 4.5\text{ to }5.5\text{ V}$ , No load, $V_{IC} = V_{DD}/2\text{ V}$	25°C	70	79		
		Full range	65			

† Full range is 0°C to 70°C for C suffix and -40°C to 125°C for I suffix. If not specified, full range is -40°C to 125°C.



# TLV4110, TLV4111, TLV4112, TLV4113

## FAMILY OF HIGH OUTPUT DRIVE OPERATIONAL AMPLIFIERS WITH SHUTDOWN

SLOS289E – DECEMBER 1999 – REVISED SEPTEMBER 2006

electrical characteristics at specified free-air temperature,  $V_{DD} = 3\text{ V}$  and  $5\text{ V}$  (unless otherwise noted) (continued)

### dynamic performance

PARAMETER		TEST CONDITIONS		$T_A^\dagger$	MIN	TYP	MAX	UNITS
GBWP	Gain bandwidth product	$R_L = 100\ \Omega$	$C_L = 10\ \text{pF}$	25°C		2.7		MHz
SR	Slew rate at unity gain	$V_{O(pp)} = 2\text{ V}$ , $R_L = 100\ \Omega$ , $C_L = 10\ \text{pF}$	$V_{DD} = 3\text{ V}$	25°C	0.8	1.57		V/ $\mu\text{s}$
				Full range	0.55			
			$V_{DD} = 5\text{ V}$	25°C	1	1.57		
				Full range	0.7			
$\phi_M$	Phase margin	$R_L = 100\ \Omega$ ,	$C_L = 10\ \text{pF}$	25°C			66	
	Gain margin						16	
$t_s$	Settling time	$V(\text{STEP})_{pp} = 1\text{ V}$ , $A_V = -1$ , $C_L = 10\ \text{pF}$ , $R_L = 100\ \Omega$	0.1%	25°C			0.7	$\mu\text{s}$
			0.01%				1.3	

$^\dagger$  Full range is 0°C to 70°C for C suffix and -40°C to 125°C for I suffix. If not specified, full range is -40°C to 125°C.

### noise/distortion performance

PARAMETER		TEST CONDITIONS		$T_A$	MIN	TYP	MAX	UNITS
THD+N	Total harmonic distortion plus noise	$V_{O(pp)} = V_{DD}/2\text{ V}$ , $R_L = 100\ \Omega$ , $f = 100\ \text{Hz}$	$A_V = 1$	25°C			0.025	
			$A_V = 10$				0.035	
			$A_V = 100$				0.15	
$V_n$	Equivalent input noise voltage	$f = 100\ \text{Hz}$	$f = 10\ \text{kHz}$	25°C			55	nV/ $\sqrt{\text{Hz}}$
							10	
$I_n$	Equivalent input noise current	$f = 1\ \text{kHz}$		25°C			0.31	fA/ $\sqrt{\text{Hz}}$

### shutdown characteristics

PARAMETER		TEST CONDITIONS		$T_A^\dagger$	MIN	TYP	MAX	UNITS
$I_{DD}(\text{SHDN})$	Supply current in shutdown mode (per channel) (TLV4110, TLV4113)	$\overline{\text{SHDN}} = 0\text{ V}$		25°C	3.4	10		$\mu\text{A}$
				Full range			15	
$t(\text{ON})$	Amplifier turn-on time $^\ddagger$	$R_L = 100\ \Omega$		25°C			1	$\mu\text{s}$
$t(\text{Off})$	Amplifier turn-off time $^\ddagger$						3.3	

$^\dagger$  Full range is 0°C to 70°C for C suffix and -40°C to 125°C for I suffix. If not specified, full range is -40°C to 125°C.

$^\ddagger$  Disable time and enable time are defined as the interval between application of the logic signal to SHDN and the point at which the supply current has reached half its final value.

**TLV4110, TLV4111, TLV4112, TLV4113**  
**FAMILY OF HIGH OUTPUT DRIVE OPERATIONAL**  
**AMPLIFIERS WITH SHUTDOWN**

SLOS289E – DECEMBER 1999 – REVISED SEPTEMBER 2006

**TYPICAL CHARACTERISTICS**

**Table of Graphs**

			<b>FIGURE</b>
$V_{IO}$	Input offset voltage	vs Common-mode input voltage	1, 2
CMRR	Common-mode rejection ratio	vs Frequency	3
$V_{OH}$	High-level output voltage	vs High-level output current	4, 6
$V_{OL}$	Low-level output voltage	vs Low-level output current	5, 7
$Z_o$	Output impedance	vs Frequency	8
$I_{DD}$	Supply current	vs Supply voltage	9
$k_{SVR}$	Power supply voltage rejection ratio	vs Frequency	10
$A_{VD}$	Differential voltage amplification and phase	vs Frequency	11
	Gain-bandwidth product	vs Supply voltage	12
SR	Slew rate	vs Supply voltage	13
		vs Temperature	14
	Total harmonic distortion+noise	vs Frequency	15
$V_n$	Equivalent input voltage noise	vs Frequency	16
	Phase margin	vs Capacitive load	17
	Voltage-follower signal pulse response		18, 19
	Inverting large-signal pulse response		20, 21
	Small-signal inverting pulse response		22
	Crosstalk	vs Frequency	23
	Shutdown forward and reverse isolation		24
	Shutdown supply current	vs Free-air temperature	25
	Shutdown supply current/output voltage		26

# TLV4110, TLV4111, TLV4112, TLV4113

## FAMILY OF HIGH OUTPUT DRIVE OPERATIONAL AMPLIFIERS WITH SHUTDOWN

SLOS289E – DECEMBER 1999 – REVISED SEPTEMBER 2006

### TYPICAL CHARACTERISTICS

**INPUT OFFSET VOLTAGE  
vs  
COMMON-MODE INPUT VOLTAGE**

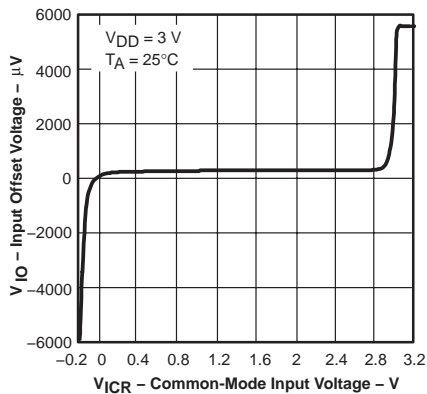

Figure 1

**INPUT OFFSET VOLTAGE  
vs  
COMMON-MODE INPUT VOLTAGE**

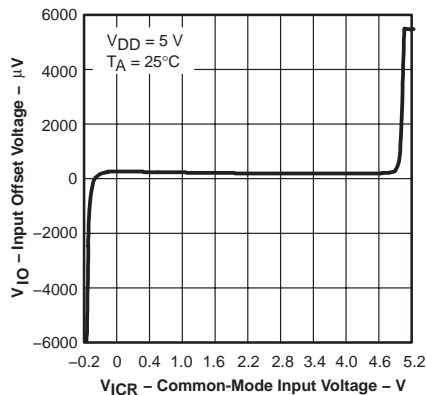

Figure 2

**COMMON-MODE REJECTION RATIO  
vs  
FREQUENCY**

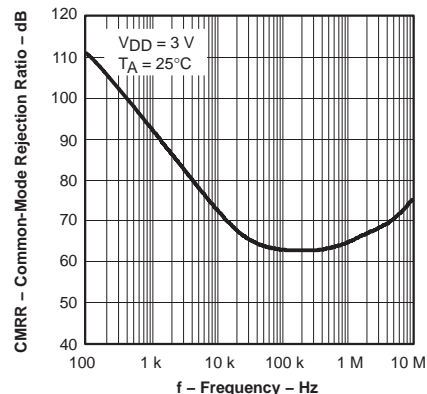

Figure 3

**HIGH-LEVEL OUTPUT VOLTAGE  
vs  
HIGH-LEVEL OUTPUT CURRENT**

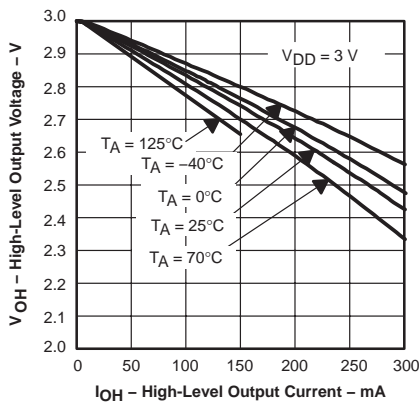

Figure 4

**LOW-LEVEL OUTPUT VOLTAGE  
vs  
LOW-LEVEL OUTPUT CURRENT**

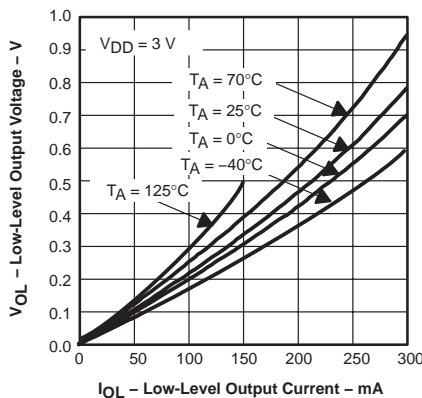

Figure 5

**HIGH-LEVEL OUTPUT VOLTAGE  
vs  
HIGH-LEVEL OUTPUT CURRENT**

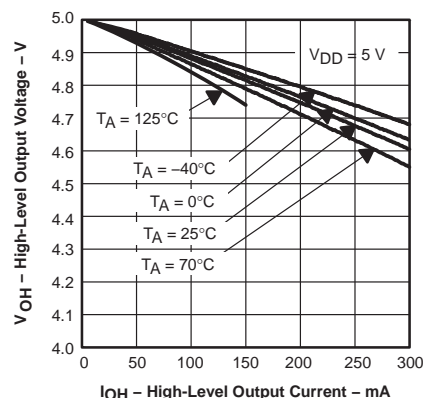

Figure 6

**LOW-LEVEL OUTPUT VOLTAGE  
vs  
LOW-LEVEL OUTPUT CURRENT**

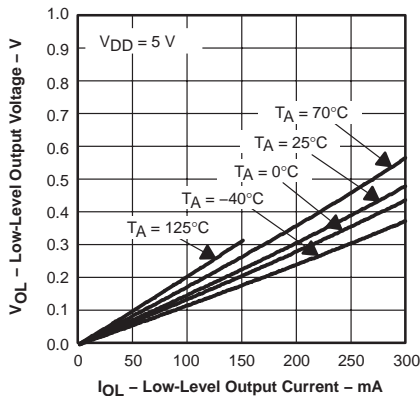

Figure 7

**OUTPUT IMPEDANCE  
vs  
FREQUENCY**

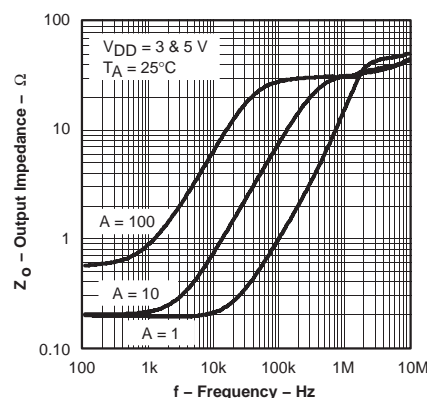

Figure 8

**SUPPLY CURRENT  
vs  
SUPPLY VOLTAGE**

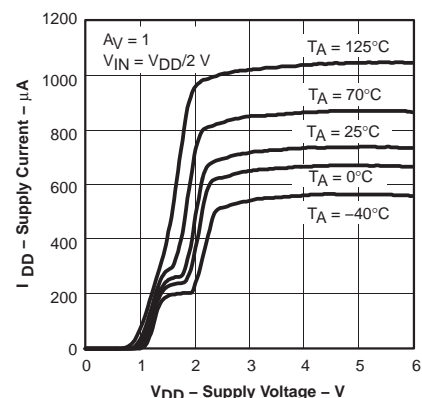

Figure 9



TYPICAL CHARACTERISTICS

POWER SUPPLY REJECTION RATIO  
 VS  
 FREQUENCY

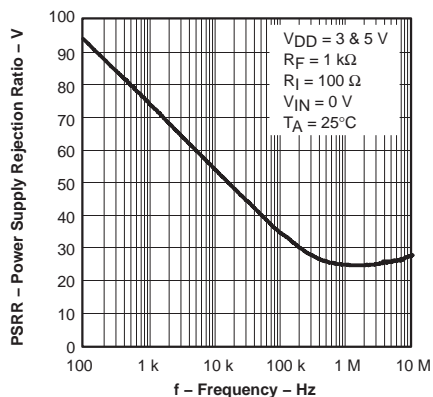

Figure 10

DIFFERENTIAL VOLTAGE  
 AMPLIFICATION AND PHASE  
 VS  
 FREQUENCY

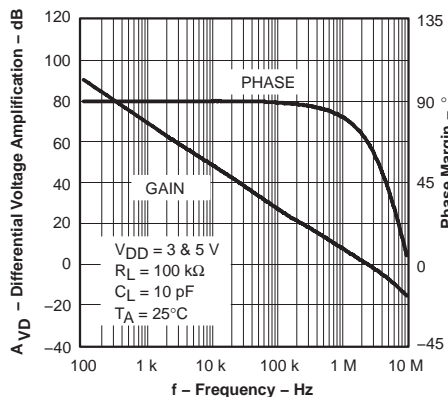

Figure 11

GAIN-BANDWIDTH PRODUCT  
 VS  
 SUPPLY VOLTAGE

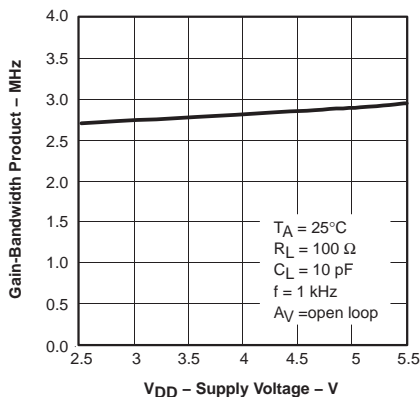

Figure 12

SLEW RATE  
 VS  
 SUPPLY VOLTAGE

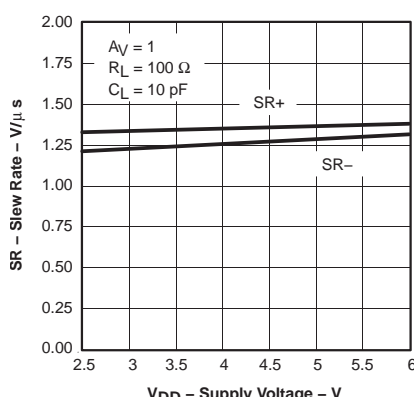

Figure 13

SLEW RATE  
 VS  
 TEMPERATURE

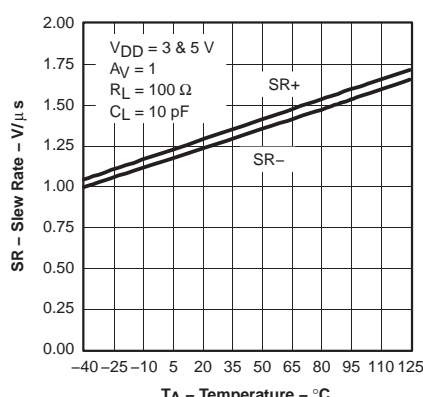

Figure 14

TOTAL HARMONIC DISTORTION+NOISE  
 VS  
 FREQUENCY

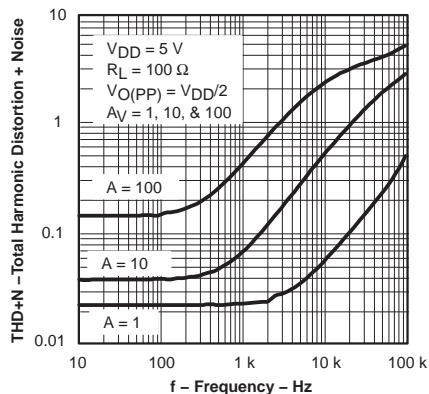

Figure 15

EQUIVALENT INPUT VOLTAGE NOISE  
 VS  
 FREQUENCY

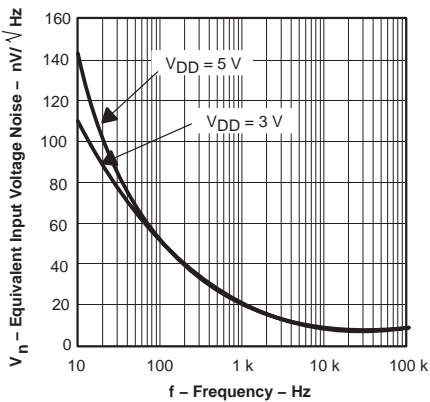

Figure 16

PHASE MARGIN  
 VS  
 CAPACITIVE LOAD

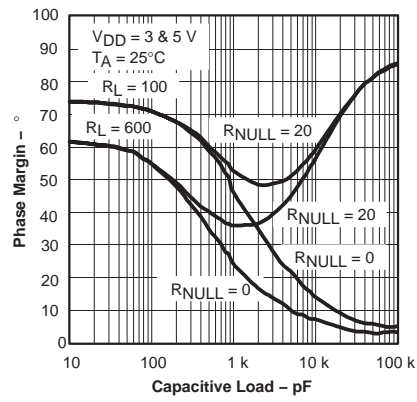

Figure 17

# TLV4110, TLV4111, TLV4112, TLV4113

## FAMILY OF HIGH OUTPUT DRIVE OPERATIONAL AMPLIFIERS WITH SHUTDOWN

SLOS289E – DECEMBER 1999 – REVISED SEPTEMBER 2006

### TYPICAL CHARACTERISTICS

**VOLTAGE-FOLLOWER  
LARGE-SIGNAL PULSE RESPONSE**

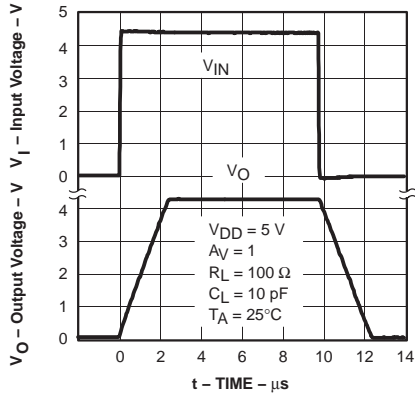

Figure 18

**VOLTAGE-FOLLOWER  
SMALL-SIGNAL PULSE RESPONSE**

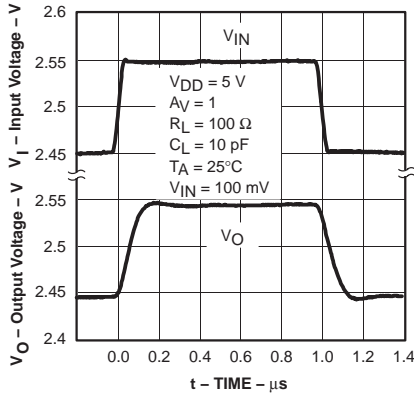

Figure 19

**INVERTING LARGE-SIGNAL  
PULSE RESPONSE**

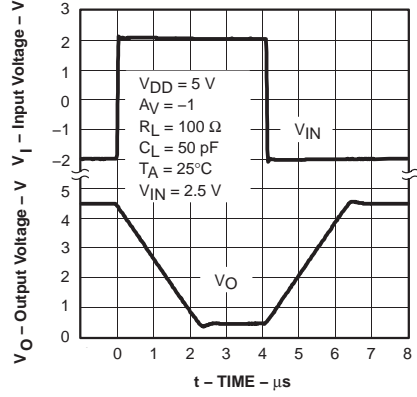

Figure 20

**INVERTING LARGE-SIGNAL  
PULSE RESPONSE**

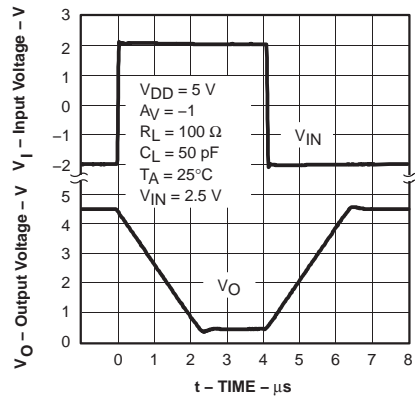

Figure 21

**SMALL-SIGNAL INVERTING  
PULSE RESPONSE**

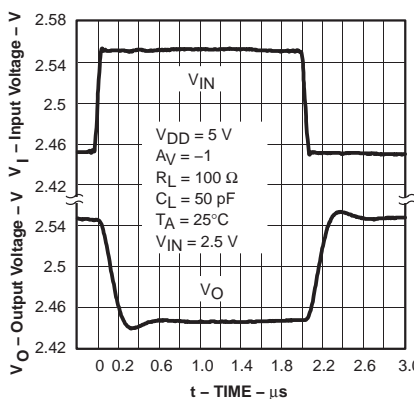

Figure 22

**CROSSTALK  
vs  
FREQUENCY**

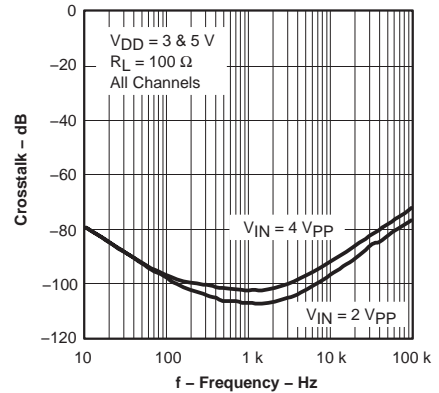

Figure 23

**SHUTDOWN FORWARD AND  
REVERSE ISOLATION**

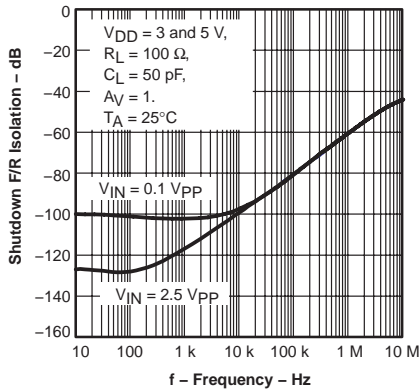

Figure 24

**SHUTDOWN SUPPLY CURRENT  
vs  
FREE-AIR TEMPERATURE**

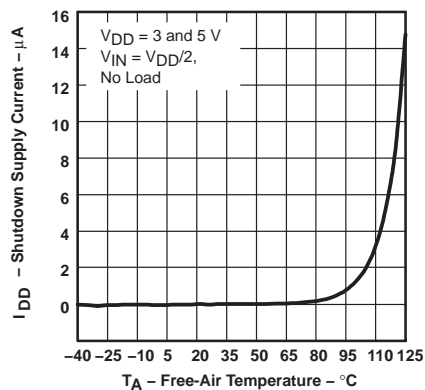

Figure 25

TYPICAL CHARACTERISTICS

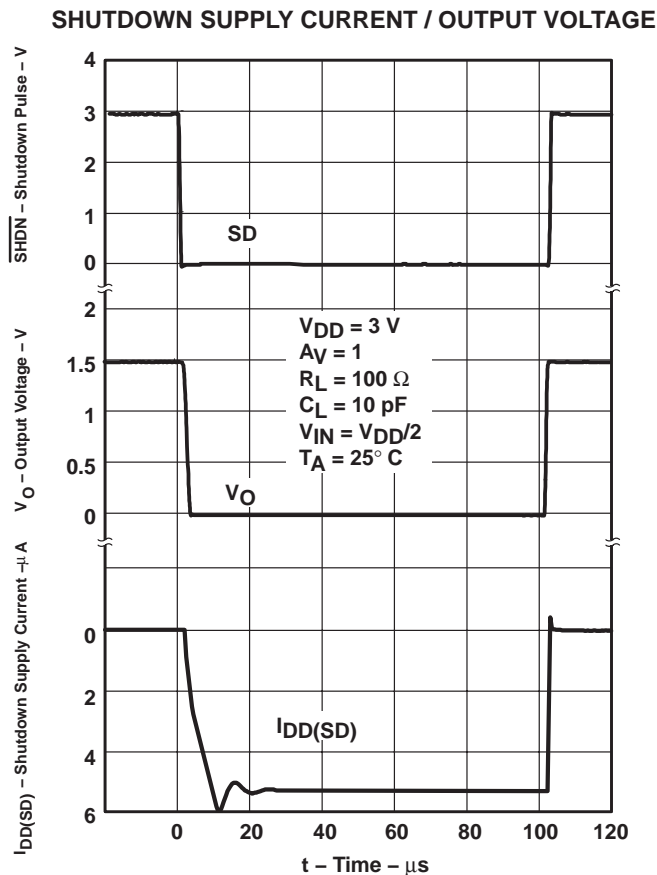

Figure 26

# TLV4110, TLV4111, TLV4112, TLV4113 FAMILY OF HIGH OUTPUT DRIVE OPERATIONAL AMPLIFIERS WITH SHUTDOWN

SLOS289E – DECEMBER 1999 – REVISED SEPTEMBER 2006

## APPLICATION INFORMATION

### shutdown function

Two members of the TLV411x family (TLV4110/3) have a shutdown terminal for conserving battery life in portable applications. When the shutdown terminal is tied low, the supply current is reduced to just nano amps per channel, the amplifier is disabled, and the outputs are placed in a high impedance mode. In order to save power in shutdown mode, an external pullup resistor is required, therefore, to enable the amplifier the shutdown terminal must be pulled high. When the shutdown terminal is left floating, care should be taken to ensure that parasitic leakage current at the shutdown terminal does not inadvertently place the operational amplifier into shutdown.

### driving a capacitive load

When the amplifier is configured in this manner, capacitive loading directly on the output will decrease the device's phase margin leading to high frequency ringing or oscillations. Therefore, for capacitive loads of greater than 1 nF, it is recommended that a resistor be placed in series ( $R_{NULL}$ ) with the output of the amplifier, as shown in Figure 27. A maximum value of 20  $\Omega$  should work well for most applications.

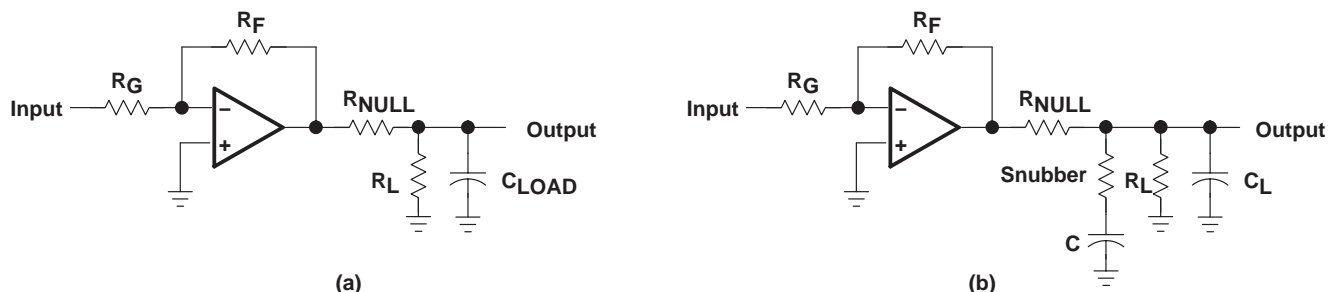

Figure 27. Driving a Capacitive Load

### offset voltage

The output offset voltage, ( $V_{OO}$ ) is the sum of the input offset voltage ( $V_{IO}$ ) and both input bias currents ( $I_{IB}$ ) times the corresponding gains. The following schematic and formula can be used to calculate the output offset voltage:

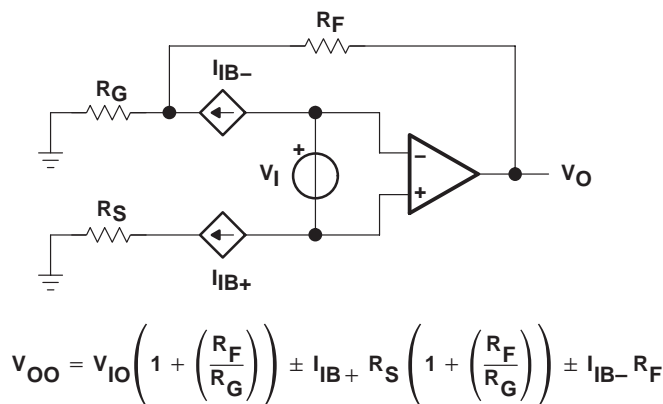
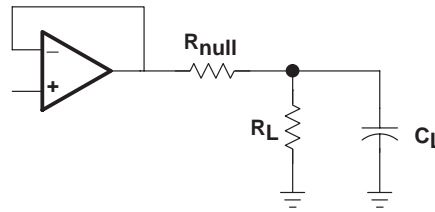

Figure 28. Output Offset Voltage Model

**APPLICATION INFORMATION**



**Figure 29**

**general power design considerations**

When driving heavy loads at high junction temperatures there is an increased probability of electromigration affecting the long term reliability of ICs. Therefore for this not to be an issue either:

- The output current must be limited (at these high junction temperatures).
- or
- The junction temperature must be limited.

The maximum continuous output current at a die temperature 150°C will be 1/3 of the current at 105°C.

The junction temperature will be dependent on the ambient temperature around the IC, thermal impedance from the die to the ambient and power dissipated within the IC.

$$T_J = T_A + \theta_{JA} \times P_{DIS}$$

Where:

$P_{DIS}$  is the IC power dissipation and is equal to the output current multiplied by the voltage dropped across the output of the IC.

$\theta_{JA}$  is the thermal impedance between the junction and the ambient temperature of the IC.

$T_J$  is the junction temperature.

$T_A$  is the ambient temperature.

Reducing one or more of these factors results in a reduced die temperature. The 8-pin SOIC (small outline integrated circuit) has a thermal impedance from junction to ambient of 176°C/W. For this reason it is recommended that the maximum power dissipation of the 8-pin SOIC package be limited to 350 mW, with peak dissipation of 700 mW as long as the RMS value is less than 350 mW.

The use of the MSOP PowerPAD™ dramatically reduces the thermal impedance from junction to case. And with correct mounting, the reduced thermal impedance greatly increases the IC's permissible power dissipation and output current handling capability. For example, the power dissipation of the PowerPAD™ is increased to above 1 W. Sinusoidal and pulse-width modulated output signals also increase the output current capability. The equivalent dc current is proportional to the square-root of the duty cycle:

$$I_{DC(EQ)} = I_{Cont} \times \sqrt{(\text{duty cycle})}$$

CURRENT DUTY CYCLE AT PEAK RATED CURRENT	EQUIVALENT DC CURRENT AS A PERCENTAGE OF PEAK
100	100
70	84
50	71

Note that with an operational amplifier, a duty cycle of 70% would often result in the op amp sourcing current 70% of the time and sinking current 30%, therefore, the equivalent dc current would still be 0.84 times the continuous current rating at a particular junction temperature.

# TLV4110, TLV4111, TLV4112, TLV4113 FAMILY OF HIGH OUTPUT DRIVE OPERATIONAL AMPLIFIERS WITH SHUTDOWN

SLOS289E – DECEMBER 1999 – REVISED SEPTEMBER 2006

## APPLICATION INFORMATION

### general PowerPAD design considerations

The TLV411x is available in a thermally-enhanced PowerPAD family of packages. These packages are constructed using a downset leadframe upon which the die is mounted [see Figure 30(a) and Figure 30(b)]. This arrangement results in the lead frame being exposed as a thermal pad on the underside of the package [see Figure 30(c)]. Because this thermal pad has direct thermal contact with the die, excellent thermal performance can be achieved by providing a good thermal path away from the thermal pad.

The PowerPAD package allows for both assembly and thermal management in one manufacturing operation. During the surface-mount solder operation (when the leads are being soldered), the thermal pad must be soldered to a copper area underneath the package. Through the use of thermal paths within this copper area, heat can be conducted away from the package into either a ground plane or other heat dissipating device.

Soldering the PowerPAD to the PCB is always recommended, even with applications that have low-power dissipation. This provides the necessary thermal and mechanical connection between the lead frame die pad and the PCB.

The PowerPAD package represents a breakthrough in combining the small area and ease of assembly of surface mount with mechanical methods of heatsinking.

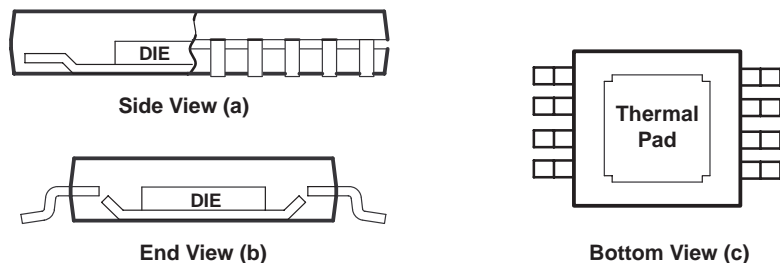

NOTE A: The thermal pad is electrically isolated from all terminals in the package.

**Figure 30. Views of Thermally-Enhanced DGN Package**

## APPLICATION INFORMATION

Although there are many ways to properly heatsink the PowerPAD package, the following steps illustrate the recommended approach.

### general PowerPAD design considerations (continued)

1. The thermal pad must be connected to the most negative supply voltage on the device, GND.
2. Prepare the PCB with a top side etch pattern as illustrated in the thermal land pattern mechanical drawings at the end of this document. There should be etch for the leads as well as etch for the thermal pad.
3. Place five holes in the area of the thermal pad. These holes should be 13 mils in diameter. Keep them small so that solder wicking through the holes is not a problem during reflow.
4. Additional vias may be placed anywhere along the thermal plane outside of the thermal pad area. This helps dissipate the heat generated by the TLV411x IC. These additional vias may be larger than the 13-mil diameter vias directly under the thermal pad. They can be larger because they are not in the thermal pad area to be soldered so that wicking is not a problem.
5. Connect all holes to the internal ground plane that is at the same voltage potential as the device GND pin.
6. When connecting these holes to the ground plane, do not use the typical web or spoke via connection methodology. Web connections have a high thermal resistance connection that is useful for slowing the heat transfer during soldering operations. This makes the soldering of vias that have plane connections easier. In this application, however, low thermal resistance is desired for the most efficient heat transfer. Therefore, the holes under the TLV411x PowerPAD package should make their connection to the internal ground plane with a complete connection around the entire circumference of the plated-through hole.
7. The top-side solder mask should leave the terminals of the package and the thermal pad area with its five holes exposed. The bottom-side solder mask should cover the five holes of the thermal pad area. This prevents solder from being pulled away from the thermal pad area during the reflow process.
8. Apply solder paste to the exposed thermal pad area and all of the IC terminals.
9. With these preparatory steps in place, the TLV411x IC is simply placed in position and run through the solder reflow operation as any standard surface-mount component. This results in a part that is properly installed.

For a given  $\theta_{JA}$ , the maximum power dissipation is shown in Figure 31 and is calculated by the following formula:

$$P_D = \left( \frac{T_{MAX} - T_A}{\theta_{JA}} \right)$$

Where:

$P_D$  = Maximum power dissipation of TLV411x IC (watts)

$T_{MAX}$  = Absolute maximum junction temperature (150°C)

$T_A$  = Free-ambient air temperature (°C)

$\theta_{JA}$  =  $\theta_{JC} + \theta_{CA}$

$\theta_{JC}$  = Thermal coefficient from junction to case

$\theta_{CA}$  = Thermal coefficient from case to ambient air (°C/W)

**TLV4110, TLV4111, TLV4112, TLV4113**  
**FAMILY OF HIGH OUTPUT DRIVE OPERATIONAL**  
**AMPLIFIERS WITH SHUTDOWN**

SLOS289E – DECEMBER 1999 – REVISED SEPTEMBER 2006

**APPLICATION INFORMATION**

**general PowerPAD design considerations (continued)**

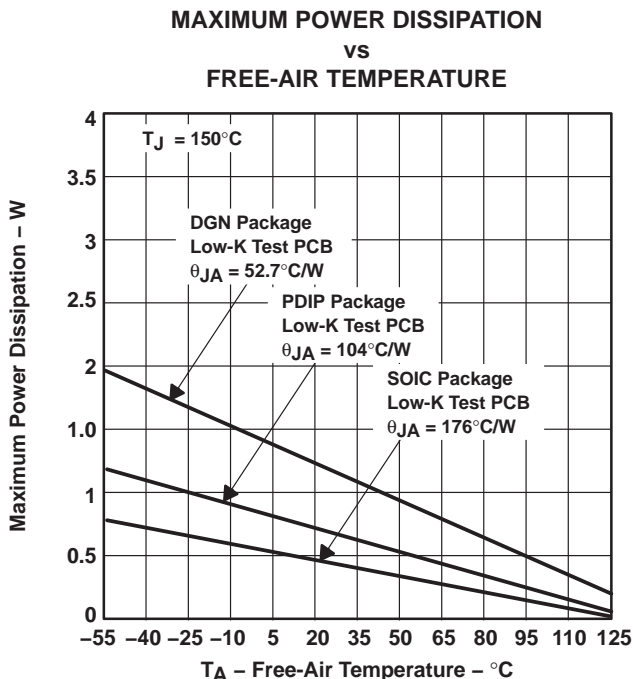

NOTE A: Results are with no air flow and using JEDEC Standard Low-K test PCB.

**Figure 31. Maximum Power Dissipation vs Free-Air Temperature**

The next consideration is the package constraints. The two sources of heat within an amplifier are quiescent power and output power. The designer should never forget about the quiescent heat generated within the device, especially multi-amplifier devices. Because these devices have linear output stages (Class A-B), most of the heat dissipation is at low output voltages with high output currents.

The other key factor when dealing with power dissipation is how the devices are mounted on the PCB. The PowerPAD devices are extremely useful for heat dissipation. But, the device should always be soldered to a copper plane to fully use the heat dissipation properties of the PowerPAD. The SOIC package, on the other hand, is highly dependent on how it is mounted on the PCB. As more trace and copper area is placed around the device,  $\theta_{JA}$  decreases and the heat dissipation capability increases. The currents and voltages shown in these graphs are for the total package. For the dual amplifier packages, the sum of the RMS output currents and voltages should be used to choose the proper package.







**PACKAGING INFORMATION**

Orderable Device	Status <sup>(1)</sup>	Package Type	Package Drawing	Pins	Package Qty	Eco Plan <sup>(2)</sup>	Lead/Ball Finish	MSL Peak Temp <sup>(3)</sup>
TLV4110ID	ACTIVE	SOIC	D	8	75	Green (RoHS & no Sb/Br)	CU NIPDAU	Level-1-260C-UNLIM
TLV4110IDG4	ACTIVE	SOIC	D	8	75	Green (RoHS & no Sb/Br)	CU NIPDAU	Level-1-260C-UNLIM
TLV4110IDGNR	ACTIVE	MSOP-Power PAD	DGN	8	2500	Green (RoHS & no Sb/Br)	CU NIPDAU	Level-1-260C-UNLIM
TLV4110IDGNRG4	ACTIVE	MSOP-Power PAD	DGN	8	2500	Green (RoHS & no Sb/Br)	CU NIPDAU	Level-1-260C-UNLIM
TLV4110IDR	ACTIVE	SOIC	D	8	2500	Green (RoHS & no Sb/Br)	CU NIPDAU	Level-1-260C-UNLIM
TLV4110IDRG4	ACTIVE	SOIC	D	8	2500	Green (RoHS & no Sb/Br)	CU NIPDAU	Level-1-260C-UNLIM
TLV4110IP	ACTIVE	PDIP	P	8	50	Pb-Free (RoHS)	CU NIPDAU	N / A for Pkg Type
TLV4110IPE4	ACTIVE	PDIP	P	8	50	Pb-Free (RoHS)	CU NIPDAU	N / A for Pkg Type
TLV4111CD	ACTIVE	SOIC	D	8	75	Green (RoHS & no Sb/Br)	CU NIPDAU	Level-1-260C-UNLIM
TLV4111CDG4	ACTIVE	SOIC	D	8	75	Green (RoHS & no Sb/Br)	CU NIPDAU	Level-1-260C-UNLIM
TLV4111CDGN	ACTIVE	MSOP-Power PAD	DGN	8	80	Green (RoHS & no Sb/Br)	CU NIPDAU	Level-1-260C-UNLIM
TLV4111CDGNG4	ACTIVE	MSOP-Power PAD	DGN	8	80	Green (RoHS & no Sb/Br)	CU NIPDAU	Level-1-260C-UNLIM
TLV4111ID	ACTIVE	SOIC	D	8	75	Green (RoHS & no Sb/Br)	CU NIPDAU	Level-1-260C-UNLIM
TLV4111IDG4	ACTIVE	SOIC	D	8	75	Green (RoHS & no Sb/Br)	CU NIPDAU	Level-1-260C-UNLIM
TLV4111IDGN	ACTIVE	MSOP-Power PAD	DGN	8	80	Green (RoHS & no Sb/Br)	CU NIPDAU	Level-1-260C-UNLIM
TLV4111IDGNG4	ACTIVE	MSOP-Power PAD	DGN	8	80	Green (RoHS & no Sb/Br)	CU NIPDAU	Level-1-260C-UNLIM
TLV4111IDGNR	ACTIVE	MSOP-Power PAD	DGN	8	2500	Green (RoHS & no Sb/Br)	CU NIPDAU	Level-1-260C-UNLIM
TLV4111IDGNRG4	ACTIVE	MSOP-Power PAD	DGN	8	2500	Green (RoHS & no Sb/Br)	CU NIPDAU	Level-1-260C-UNLIM
TLV4111IDR	ACTIVE	SOIC	D	8	2500	Green (RoHS & no Sb/Br)	CU NIPDAU	Level-1-260C-UNLIM
TLV4111IDRG4	ACTIVE	SOIC	D	8	2500	Green (RoHS & no Sb/Br)	CU NIPDAU	Level-1-260C-UNLIM
TLV4112CD	ACTIVE	SOIC	D	8	75	Green (RoHS & no Sb/Br)	CU NIPDAU	Level-1-260C-UNLIM
TLV4112CDG4	ACTIVE	SOIC	D	8	75	Green (RoHS & no Sb/Br)	CU NIPDAU	Level-1-260C-UNLIM

Orderable Device	Status <sup>(1)</sup>	Package Type	Package Drawing	Pins	Package Qty	Eco Plan <sup>(2)</sup>	Lead/Ball Finish	MSL Peak Temp <sup>(3)</sup>
						no Sb/Br)		
TLV4112CDGN	ACTIVE	MSOP-Power PAD	DGN	8	80	Green (RoHS & no Sb/Br)	CU NIPDAU	Level-1-260C-UNLIM
TLV4112CDGNG4	ACTIVE	MSOP-Power PAD	DGN	8	80	Green (RoHS & no Sb/Br)	CU NIPDAU	Level-1-260C-UNLIM
TLV4112CP	ACTIVE	PDIP	P	8	50	Pb-Free (RoHS)	CU NIPDAU	N / A for Pkg Type
TLV4112CPE4	ACTIVE	PDIP	P	8	50	Pb-Free (RoHS)	CU NIPDAU	N / A for Pkg Type
TLV4112ID	ACTIVE	SOIC	D	8	75	Green (RoHS & no Sb/Br)	CU NIPDAU	Level-1-260C-UNLIM
TLV4112IDG4	ACTIVE	SOIC	D	8	75	Green (RoHS & no Sb/Br)	CU NIPDAU	Level-1-260C-UNLIM
TLV4112IDGN	ACTIVE	MSOP-Power PAD	DGN	8	80	Green (RoHS & no Sb/Br)	CU NIPDAU	Level-1-260C-UNLIM
TLV4112IDGNG4	ACTIVE	MSOP-Power PAD	DGN	8	80	Green (RoHS & no Sb/Br)	CU NIPDAU	Level-1-260C-UNLIM
TLV4112IDGNR	ACTIVE	MSOP-Power PAD	DGN	8	2500	Green (RoHS & no Sb/Br)	CU NIPDAU	Level-1-260C-UNLIM
TLV4112IDGNRG4	ACTIVE	MSOP-Power PAD	DGN	8	2500	Green (RoHS & no Sb/Br)	CU NIPDAU	Level-1-260C-UNLIM
TLV4112IDR	ACTIVE	SOIC	D	8	2500	Green (RoHS & no Sb/Br)	CU NIPDAU	Level-1-260C-UNLIM
TLV4112IDRG4	ACTIVE	SOIC	D	8	2500	Green (RoHS & no Sb/Br)	CU NIPDAU	Level-1-260C-UNLIM
TLV4112IP	ACTIVE	PDIP	P	8	50	Pb-Free (RoHS)	CU NIPDAU	N / A for Pkg Type
TLV4112IPE4	ACTIVE	PDIP	P	8	50	Pb-Free (RoHS)	CU NIPDAU	N / A for Pkg Type
TLV4113CDGQ	ACTIVE	MSOP-Power PAD	DGQ	10	80	Green (RoHS & no Sb/Br)	CU NIPDAU	Level-1-260C-UNLIM
TLV4113CDGQG4	ACTIVE	MSOP-Power PAD	DGQ	10	80	Green (RoHS & no Sb/Br)	CU NIPDAU	Level-1-260C-UNLIM
TLV4113CDGQR	ACTIVE	MSOP-Power PAD	DGQ	10	2500	Green (RoHS & no Sb/Br)	CU NIPDAU	Level-1-260C-UNLIM
TLV4113CDGQRG4	ACTIVE	MSOP-Power PAD	DGQ	10	2500	Green (RoHS & no Sb/Br)	CU NIPDAU	Level-1-260C-UNLIM
TLV4113ID	ACTIVE	SOIC	D	14	50	Green (RoHS & no Sb/Br)	CU NIPDAU	Level-1-260C-UNLIM
TLV4113IDG4	ACTIVE	SOIC	D	14	50	Green (RoHS & no Sb/Br)	CU NIPDAU	Level-1-260C-UNLIM
TLV4113IDGQ	ACTIVE	MSOP-Power	DGQ	10	80	Green (RoHS & no Sb/Br)	CU NIPDAU	Level-1-260C-UNLIM

Orderable Device	Status <sup>(1)</sup>	Package Type	Package Drawing	Pins	Package Qty	Eco Plan <sup>(2)</sup>	Lead/Ball Finish	MSL Peak Temp <sup>(3)</sup>
		PAD						
TLV4113IDGQG4	ACTIVE	MSOP-Power PAD	DGQ	10	80	Green (RoHS & no Sb/Br)	CU NIPDAU	Level-1-260C-UNLIM
TLV4113IDGQR	ACTIVE	MSOP-Power PAD	DGQ	10	2500	Green (RoHS & no Sb/Br)	CU NIPDAU	Level-1-260C-UNLIM
TLV4113IDGQRG4	ACTIVE	MSOP-Power PAD	DGQ	10	2500	Green (RoHS & no Sb/Br)	CU NIPDAU	Level-1-260C-UNLIM
TLV4113IN	ACTIVE	PDIP	N	14	25	Pb-Free (RoHS)	CU NIPDAU	N / A for Pkg Type
TLV4113INE4	ACTIVE	PDIP	N	14	25	Pb-Free (RoHS)	CU NIPDAU	N / A for Pkg Type

<sup>(1)</sup> The marketing status values are defined as follows:

**ACTIVE:** Product device recommended for new designs.

**LIFEBUY:** TI has announced that the device will be discontinued, and a lifetime-buy period is in effect.

**NRND:** Not recommended for new designs. Device is in production to support existing customers, but TI does not recommend using this part in a new design.

**PREVIEW:** Device has been announced but is not in production. Samples may or may not be available.

**OBsolete:** TI has discontinued the production of the device.

<sup>(2)</sup> Eco Plan - The planned eco-friendly classification: Pb-Free (RoHS), Pb-Free (RoHS Exempt), or Green (RoHS & no Sb/Br) - please check <http://www.ti.com/productcontent> for the latest availability information and additional product content details.

**TBD:** The Pb-Free/Green conversion plan has not been defined.

**Pb-Free (RoHS):** TI's terms "Lead-Free" or "Pb-Free" mean semiconductor products that are compatible with the current RoHS requirements for all 6 substances, including the requirement that lead not exceed 0.1% by weight in homogeneous materials. Where designed to be soldered at high temperatures, TI Pb-Free products are suitable for use in specified lead-free processes.

**Pb-Free (RoHS Exempt):** This component has a RoHS exemption for either 1) lead-based flip-chip solder bumps used between the die and package, or 2) lead-based die adhesive used between the die and leadframe. The component is otherwise considered Pb-Free (RoHS compatible) as defined above.

**Green (RoHS & no Sb/Br):** TI defines "Green" to mean Pb-Free (RoHS compatible), and free of Bromine (Br) and Antimony (Sb) based flame retardants (Br or Sb do not exceed 0.1% by weight in homogeneous material)

<sup>(3)</sup> MSL, Peak Temp. -- The Moisture Sensitivity Level rating according to the JEDEC industry standard classifications, and peak solder temperature.

**Important Information and Disclaimer:**The information provided on this page represents TI's knowledge and belief as of the date that it is provided. TI bases its knowledge and belief on information provided by third parties, and makes no representation or warranty as to the accuracy of such information. Efforts are underway to better integrate information from third parties. TI has taken and continues to take reasonable steps to provide representative and accurate information but may not have conducted destructive testing or chemical analysis on incoming materials and chemicals. TI and TI suppliers consider certain information to be proprietary, and thus CAS numbers and other limited information may not be available for release.

In no event shall TI's liability arising out of such information exceed the total purchase price of the TI part(s) at issue in this document sold by TI to Customer on an annual basis.

**OTHER QUALIFIED VERSIONS OF TLV4113 :**

- Enhanced Product: [TLV4113-EP](#)

NOTE: Qualified Version Definitions:

- Enhanced Product - Supports Defense, Aerospace and Medical Applications

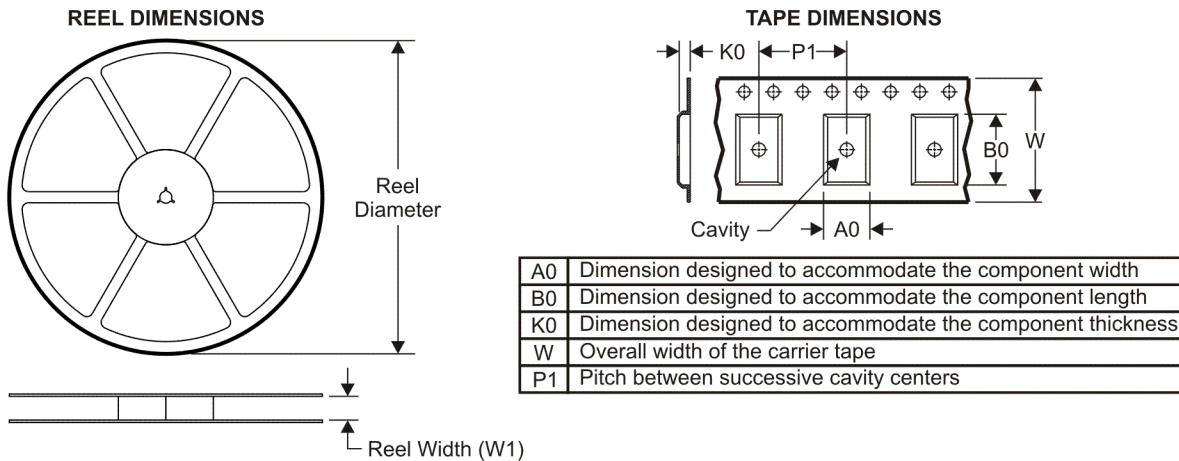
**TAPE AND REEL INFORMATION**

**QUADRANT ASSIGNMENTS FOR PIN 1 ORIENTATION IN TAPE**

\*All dimensions are nominal

Device	Package Type	Package Drawing	Pins	SPQ	Reel Diameter (mm)	Reel Width W1 (mm)	A0 (mm)	B0 (mm)	K0 (mm)	P1 (mm)	W (mm)	Pin1 Quadrant
TLV4110IDGNR	MSOP-Power PAD	DGN	8	2500	330.0	12.4	5.3	3.4	1.4	8.0	12.0	Q1
TLV4110IDR	SOIC	D	8	2500	330.0	12.4	6.4	5.2	2.1	8.0	12.0	Q1
TLV4111IDGNR	MSOP-Power PAD	DGN	8	2500	330.0	12.4	5.3	3.4	1.4	8.0	12.0	Q1
TLV4111IDR	SOIC	D	8	2500	330.0	12.4	6.4	5.2	2.1	8.0	12.0	Q1
TLV4112IDGNR	MSOP-Power PAD	DGN	8	2500	330.0	12.4	5.3	3.4	1.4	8.0	12.0	Q1
TLV4112IDR	SOIC	D	8	2500	330.0	12.4	6.4	5.2	2.1	8.0	12.0	Q1
TLV4113CDGQR	MSOP-Power PAD	DGQ	10	2500	330.0	12.4	5.3	3.4	1.4	8.0	12.0	Q1
TLV4113IDGQR	MSOP-Power PAD	DGQ	10	2500	330.0	12.4	5.3	3.4	1.4	8.0	12.0	Q1

**TAPE AND REEL BOX DIMENSIONS**

\*All dimensions are nominal

Device	Package Type	Package Drawing	Pins	SPQ	Length (mm)	Width (mm)	Height (mm)
TLV4110IDGNR	MSOP-PowerPAD	DGN	8	2500	358.0	335.0	35.0
TLV4110IDR	SOIC	D	8	2500	340.5	338.1	20.6
TLV4111IDGNR	MSOP-PowerPAD	DGN	8	2500	358.0	335.0	35.0
TLV4111IDR	SOIC	D	8	2500	340.5	338.1	20.6
TLV4112IDGNR	MSOP-PowerPAD	DGN	8	2500	358.0	335.0	35.0
TLV4112IDR	SOIC	D	8	2500	340.5	338.1	20.6
TLV4113CDGQR	MSOP-PowerPAD	DGQ	10	2500	358.0	335.0	35.0
TLV4113IDGQR	MSOP-PowerPAD	DGQ	10	2500	358.0	335.0	35.0

P (R-PDIP-T8)

PLASTIC DUAL-IN-LINE PACKAGE



4040082/E 04/2010

- NOTES:
- A. All linear dimensions are in inches (millimeters).
  - B. This drawing is subject to change without notice.
  - C. Falls within JEDEC MS-001 variation BA.

DGQ (S-PDSO-G10)

PowerPAD™ PLASTIC SMALL-OUTLINE PACKAGE

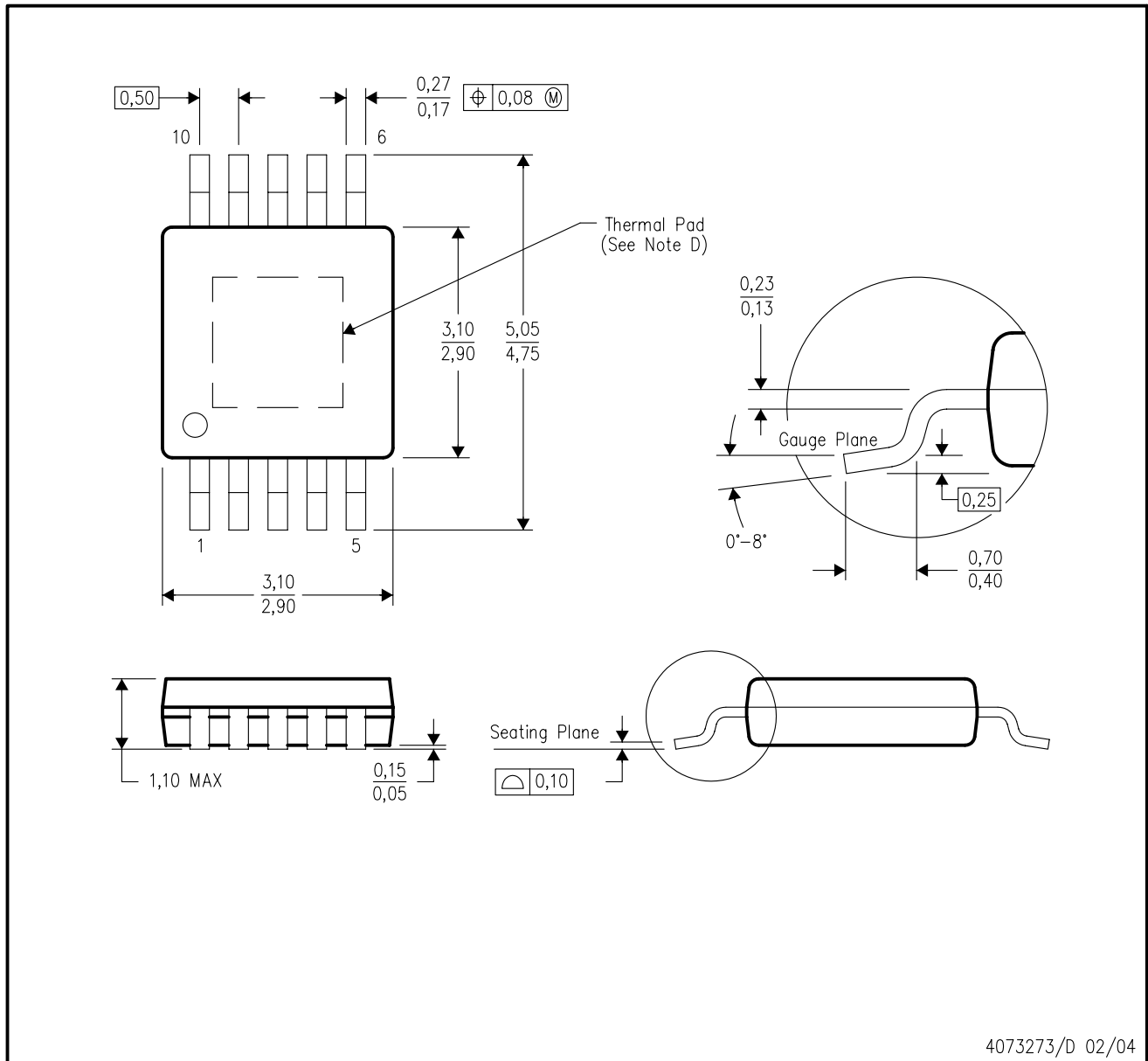

- NOTES:
- All linear dimensions are in millimeters.
  - This drawing is subject to change without notice.
  - Body dimensions do not include mold flash or protrusion.
  - This package is designed to be soldered to a thermal pad on the board. Refer to Technical Brief, PowerPAD Thermally Enhanced Package, Texas Instruments Literature No. SLMA002 for information regarding recommended board layout. This document is available at [www.ti.com](http://www.ti.com) <<http://www.ti.com>>.
  - Falls within JEDEC MO-187 variation BA-T.

PowerPAD is a trademark of Texas Instruments.



## THERMAL PAD MECHANICAL DATA

DGQ (S-PDSO-G10)

PowerPAD™ SMALL OUTLINE PACKAGE

### THERMAL INFORMATION

This PowerPAD™ package incorporates an exposed thermal pad that is designed to be attached to a printed circuit board (PCB). The thermal pad must be soldered directly to the PCB. After soldering, the PCB can be used as a heatsink. In addition, through the use of thermal vias, the thermal pad can be attached directly to the appropriate copper plane shown in the electrical schematic for the device, or alternatively, can be attached to a special heatsink structure designed into the PCB. This design optimizes the heat transfer from the integrated circuit (IC).

For additional information on the PowerPAD package and how to take advantage of its heat dissipating abilities, refer to Technical Brief, PowerPAD Thermally Enhanced Package, Texas Instruments Literature No. SLMA002 and Application Brief, PowerPAD Made Easy, Texas Instruments Literature No. SLMA004. Both documents are available at [www.ti.com](http://www.ti.com).

The exposed thermal pad dimensions for this package are shown in the following illustration.

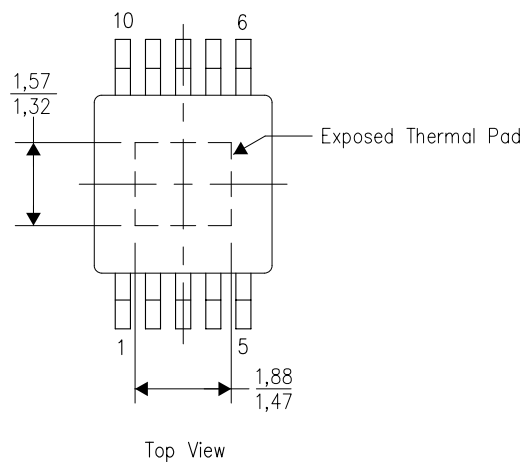

NOTE: All linear dimensions are in millimeters

Exposed Thermal Pad Dimensions

DGQ (R-PDSO-G10) PowerPAD™

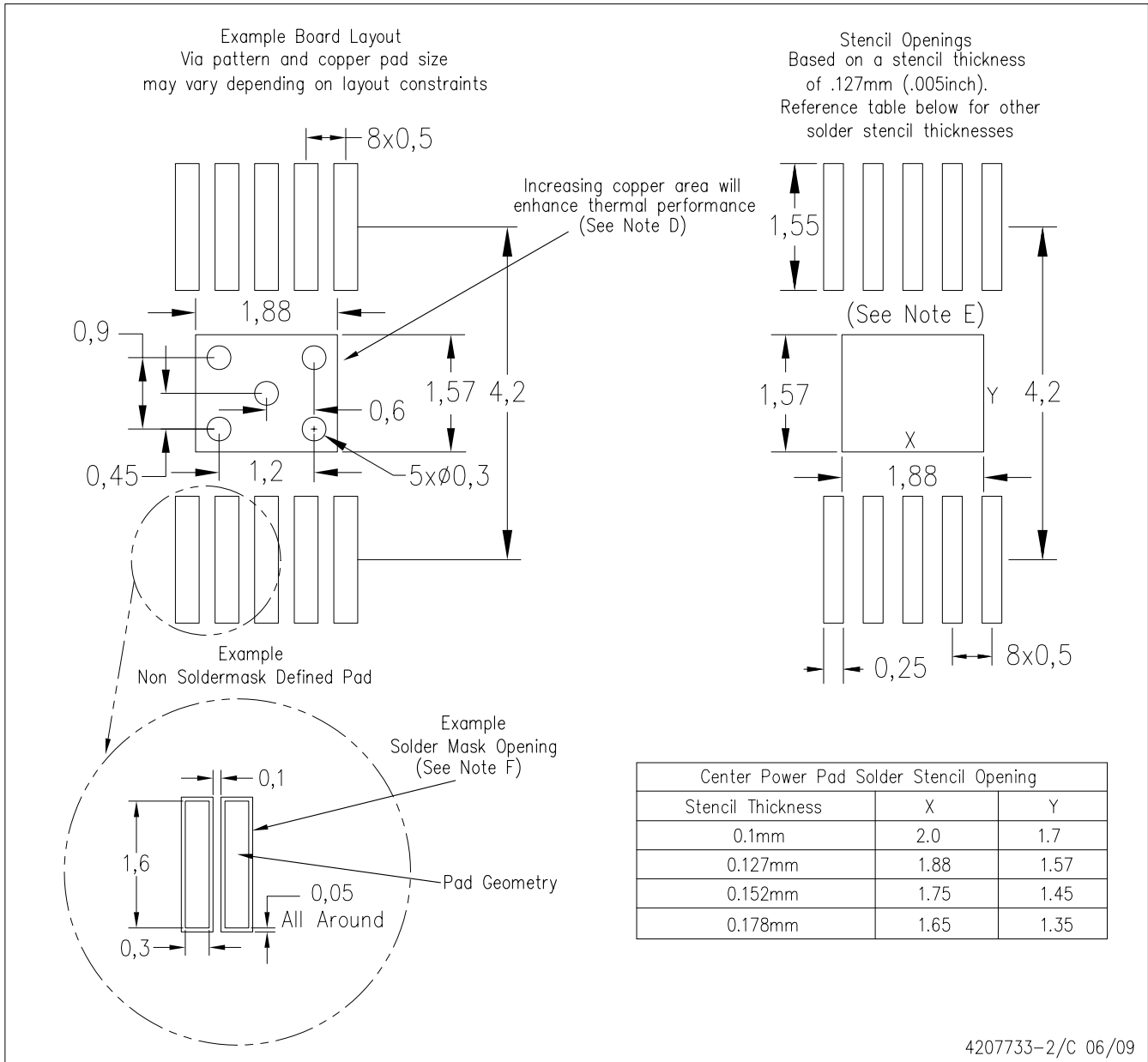

- NOTES:
- A. All linear dimensions are in millimeters.
  - B. This drawing is subject to change without notice.
  - C. Customers should place a note on the circuit board fabrication drawing not to alter the center solder mask defined pad.
  - D. This package is designed to be soldered to a thermal pad on the board. Refer to Technical Brief, PowerPad Thermally Enhanced Package, Texas Instruments Literature No. SLMA002, SLMA004, and also the Product Data Sheets for specific thermal information, via requirements, and recommended board layout. These documents are available at [www.ti.com](http://www.ti.com) <<http://www.ti.com>>. Publication IPC-7351 is recommended for alternate designs.
  - E. Laser cutting apertures with trapezoidal walls and also rounding corners will offer better paste release. Customers should contact their board assembly site for stencil design recommendations. Example stencil design based on a 50% volumetric metal load solder paste. Refer to IPC-7525 for other stencil recommendations.
  - F. Customers should contact their board fabrication site for solder mask tolerances between and around signal pads.

# MECHANICAL DATA

DGN (S-PDSO-G8)

PowerPAD™ PLASTIC SMALL-OUTLINE PACKAGE

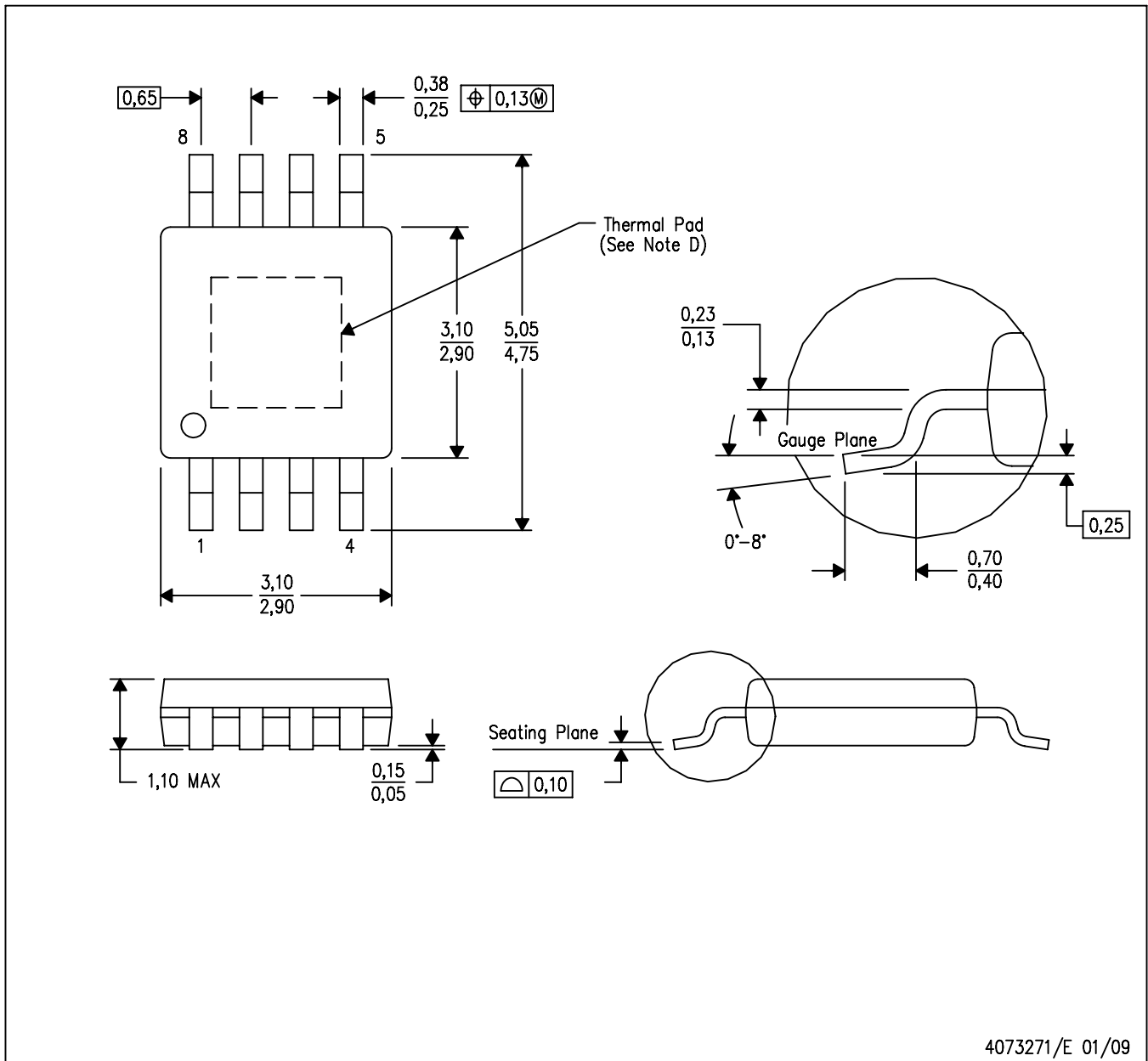

- NOTES:
- A. All linear dimensions are in millimeters.
  - B. This drawing is subject to change without notice.
  - C. Body dimensions do not include mold flash or protrusion.
  - D. This package is designed to be soldered to a thermal pad on the board. Refer to Technical Brief, PowerPAD Thermally Enhanced Package, Texas Instruments Literature No. SLMA002 for information regarding recommended board layout. This document is available at [www.ti.com](http://www.ti.com) <<http://www.ti.com>>.
  - E. Falls within JEDEC MO-187 variation AA-T

PowerPAD is a trademark of Texas Instruments.

THERMAL INFORMATION

This PowerPAD™ package incorporates an exposed thermal pad that is designed to be attached to a printed circuit board (PCB). The thermal pad must be soldered directly to the PCB. After soldering, the PCB can be used as a heatsink. In addition, through the use of thermal vias, the thermal pad can be attached directly to the appropriate copper plane shown in the electrical schematic for the device, or alternatively, can be attached to a special heatsink structure designed into the PCB. This design optimizes the heat transfer from the integrated circuit (IC).

For additional information on the PowerPAD package and how to take advantage of its heat dissipating abilities, refer to Technical Brief, PowerPAD Thermally Enhanced Package, Texas Instruments Literature No. SLMA002 and Application Brief, PowerPAD Made Easy, Texas Instruments Literature No. SLMA004. Both documents are available at [www.ti.com](http://www.ti.com).

The exposed thermal pad dimensions for this package are shown in the following illustration.

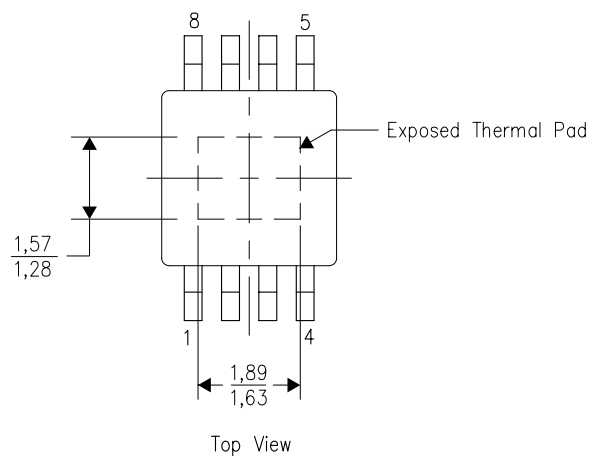

NOTE: All linear dimensions are in millimeters

Exposed Thermal Pad Dimensions

DGN (R-PDS0-G8) PowerPAD™

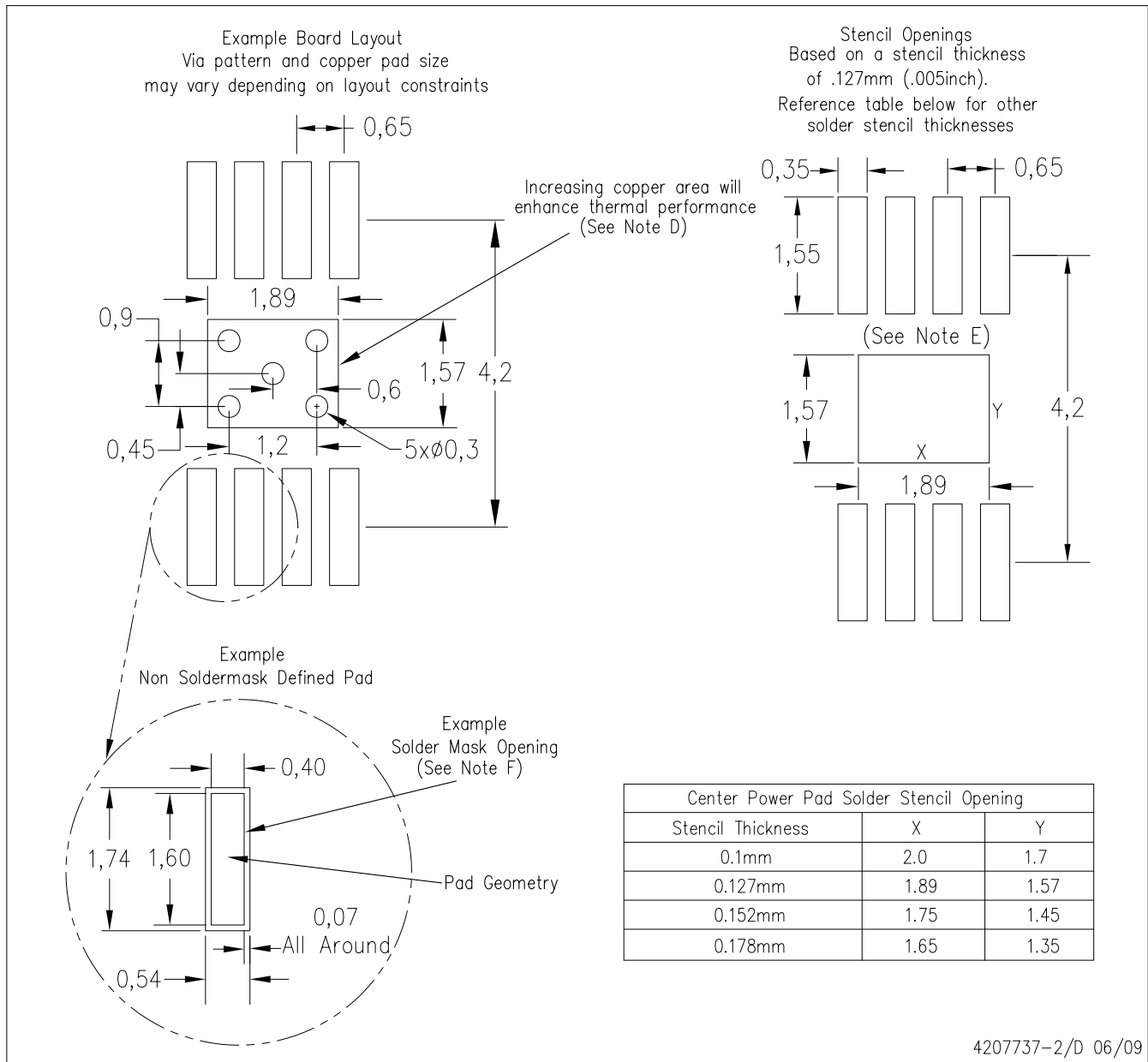



- NOTES:
- A. All linear dimensions are in millimeters.
  - B. This drawing is subject to change without notice.
  - C. Customers should place a note on the circuit board fabrication drawing not to alter the center solder mask defined pad.
  - D. This package is designed to be soldered to a thermal pad on the board. Refer to Technical Brief, PowerPad Thermally Enhanced Package, Texas Instruments Literature No. SLMA002, SLMA004, and also the Product Data Sheets for specific thermal information, via requirements, and recommended board layout. These documents are available at [www.ti.com](http://www.ti.com) <<http://www.ti.com>>. Publication IPC-7351 is recommended for alternate designs.
  - E. Laser cutting apertures with trapezoidal walls and also rounding corners will offer better paste release. Customers should contact their board assembly site for stencil design recommendations. Example stencil design based on a 50% volumetric metal load solder paste. Refer to IPC-7525 for other stencil recommendations.
  - F. Customers should contact their board fabrication site for solder mask tolerances between and around signal pads.

D (R-PDSO-G14)

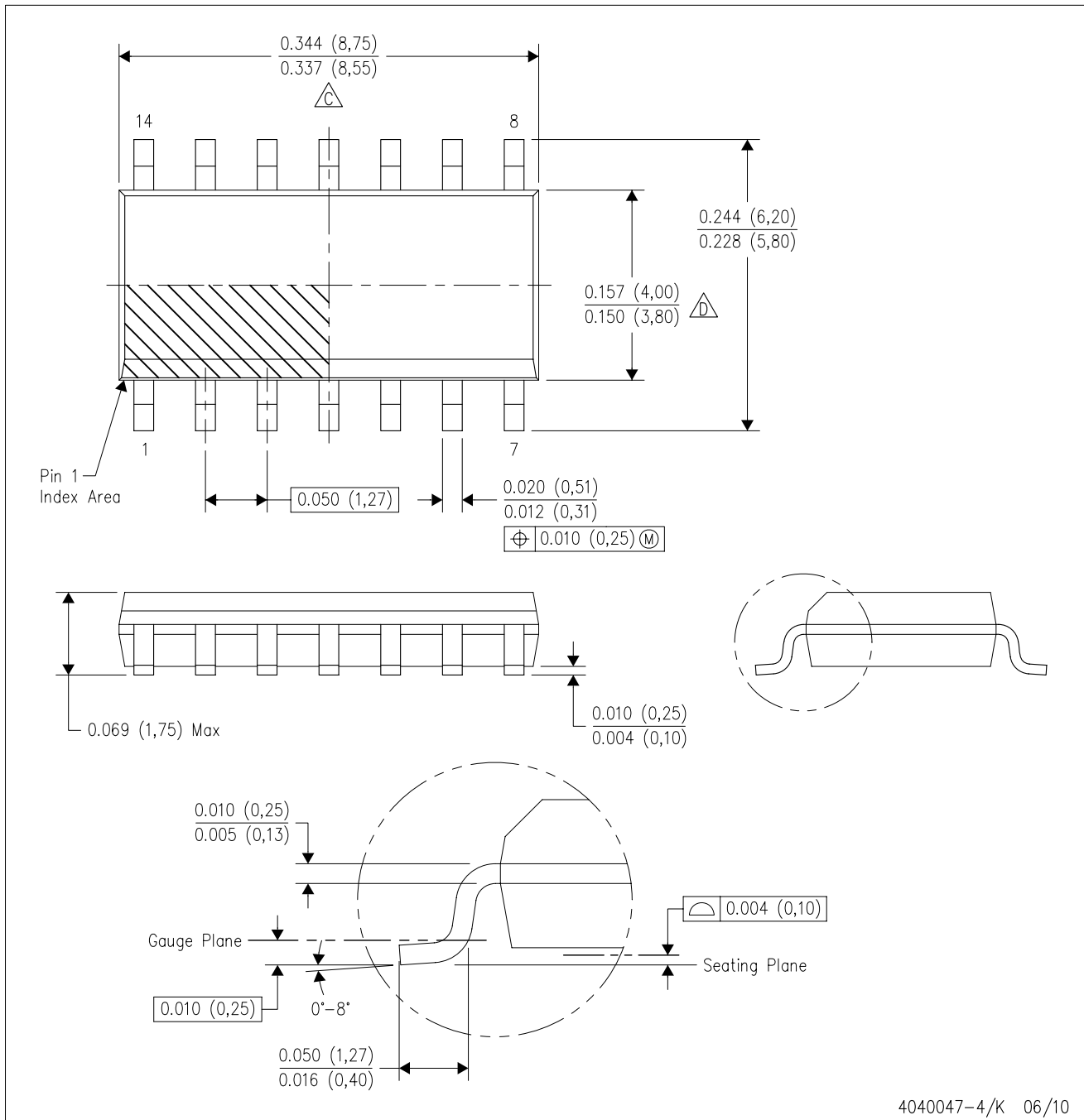
PLASTIC SMALL-OUTLINE PACKAGE



- NOTES:
- A. All linear dimensions are in inches (millimeters).
  - B. This drawing is subject to change without notice.
  -  Body length does not include mold flash, protrusions, or gate burrs. Mold flash, protrusions, or gate burrs shall not exceed .006 (0,15) per end.
  -  Body width does not include interlead flash. Interlead flash shall not exceed .017 (0,43) per side.
  - E. Reference JEDEC MS-012 variation AB.

D (R-PDSO-G14)

PLASTIC SMALL OUTLINE

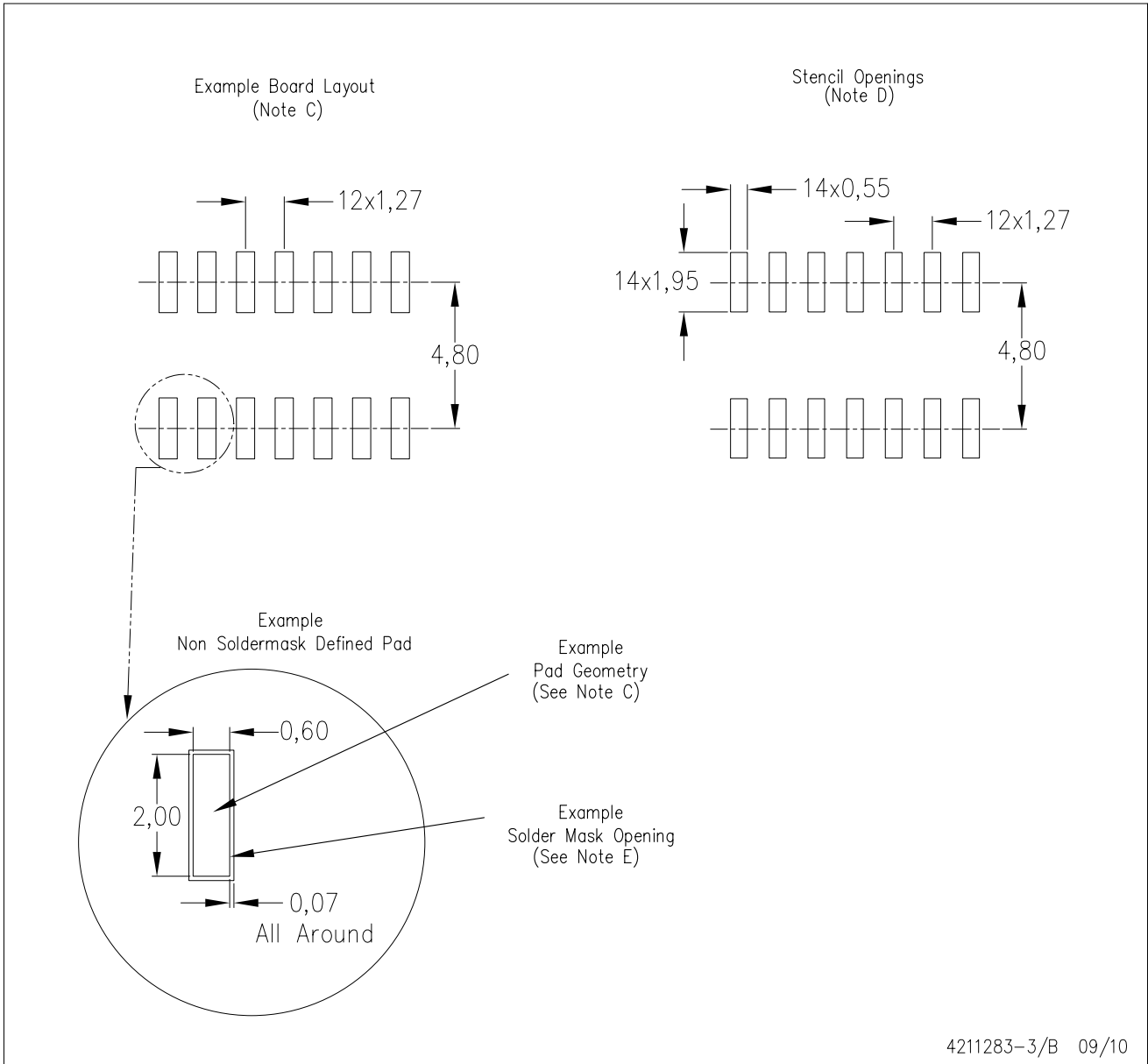

- NOTES:
- A. All linear dimensions are in millimeters.
  - B. This drawing is subject to change without notice.
  - C. Publication IPC-7351 is recommended for alternate designs.
  - D. Laser cutting apertures with trapezoidal walls and also rounding corners will offer better paste release. Customers should contact their board assembly site for stencil design recommendations. Refer to IPC-7525 for other stencil recommendations.
  - E. Customers should contact their board fabrication site for solder mask tolerances between and around signal pads.

D (R-PDSO-G8)

PLASTIC SMALL-OUTLINE PACKAGE

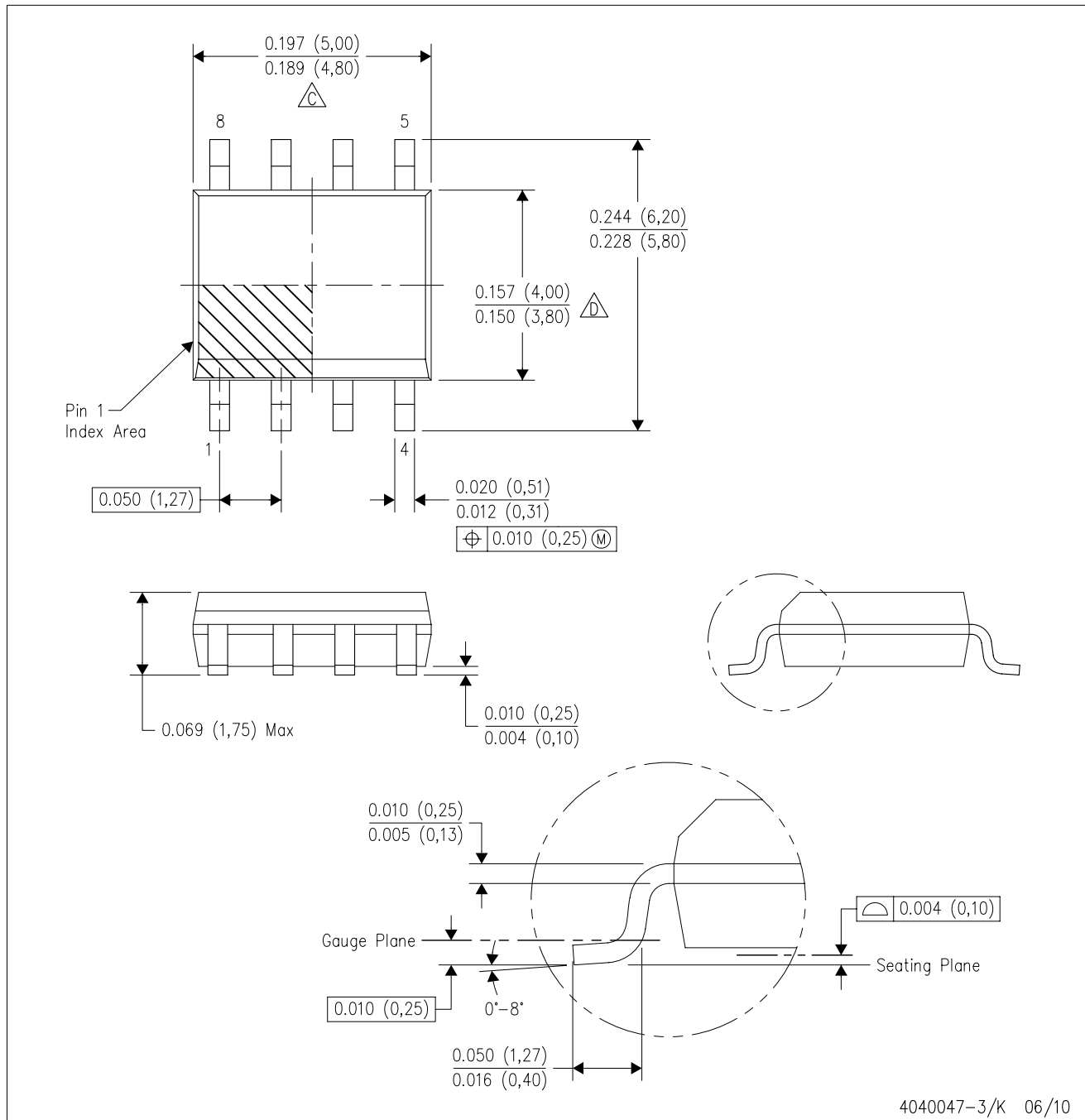

- NOTES:
- A. All linear dimensions are in inches (millimeters).
  - B. This drawing is subject to change without notice.
  - C. Body length does not include mold flash, protrusions, or gate burrs. Mold flash, protrusions, or gate burrs shall not exceed .006 (0,15) per end.
  - D. Body width does not include interlead flash. Interlead flash shall not exceed .017 (0,43) per side.
  - E. Reference JEDEC MS-012 variation AA.



D (R-PDSO-G8)

PLASTIC SMALL OUTLINE

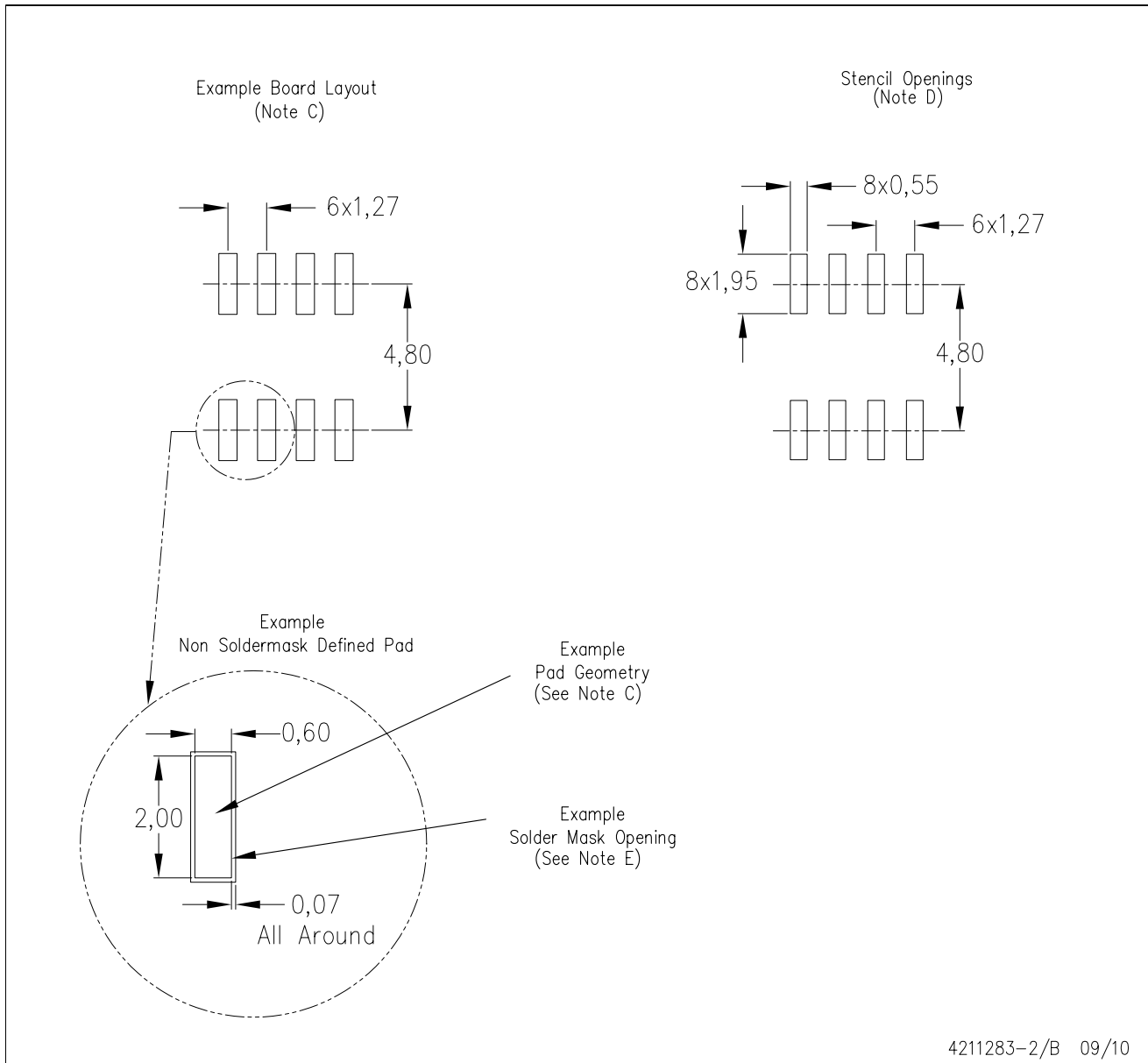

- NOTES:
- All linear dimensions are in millimeters.
  - This drawing is subject to change without notice.
  - Publication IPC-7351 is recommended for alternate designs.
  - Laser cutting apertures with trapezoidal walls and also rounding corners will offer better paste release. Customers should contact their board assembly site for stencil design recommendations. Refer to IPC-7525 for other stencil recommendations.
  - Customers should contact their board fabrication site for solder mask tolerances between and around signal pads.

## IMPORTANT NOTICE

Texas Instruments Incorporated and its subsidiaries (TI) reserve the right to make corrections, modifications, enhancements, improvements, and other changes to its products and services at any time and to discontinue any product or service without notice. Customers should obtain the latest relevant information before placing orders and should verify that such information is current and complete. All products are sold subject to TI's terms and conditions of sale supplied at the time of order acknowledgment.

TI warrants performance of its hardware products to the specifications applicable at the time of sale in accordance with TI's standard warranty. Testing and other quality control techniques are used to the extent TI deems necessary to support this warranty. Except where mandated by government requirements, testing of all parameters of each product is not necessarily performed.

TI assumes no liability for applications assistance or customer product design. Customers are responsible for their products and applications using TI components. To minimize the risks associated with customer products and applications, customers should provide adequate design and operating safeguards.

TI does not warrant or represent that any license, either express or implied, is granted under any TI patent right, copyright, mask work right, or other TI intellectual property right relating to any combination, machine, or process in which TI products or services are used. Information published by TI regarding third-party products or services does not constitute a license from TI to use such products or services or a warranty or endorsement thereof. Use of such information may require a license from a third party under the patents or other intellectual property of the third party, or a license from TI under the patents or other intellectual property of TI.

Reproduction of TI information in TI data books or data sheets is permissible only if reproduction is without alteration and is accompanied by all associated warranties, conditions, limitations, and notices. Reproduction of this information with alteration is an unfair and deceptive business practice. TI is not responsible or liable for such altered documentation. Information of third parties may be subject to additional restrictions.

Resale of TI products or services with statements different from or beyond the parameters stated by TI for that product or service voids all express and any implied warranties for the associated TI product or service and is an unfair and deceptive business practice. TI is not responsible or liable for any such statements.

TI products are not authorized for use in safety-critical applications (such as life support) where a failure of the TI product would reasonably be expected to cause severe personal injury or death, unless officers of the parties have executed an agreement specifically governing such use. Buyers represent that they have all necessary expertise in the safety and regulatory ramifications of their applications, and acknowledge and agree that they are solely responsible for all legal, regulatory and safety-related requirements concerning their products and any use of TI products in such safety-critical applications, notwithstanding any applications-related information or support that may be provided by TI. Further, Buyers must fully indemnify TI and its representatives against any damages arising out of the use of TI products in such safety-critical applications.

TI products are neither designed nor intended for use in military/aerospace applications or environments unless the TI products are specifically designated by TI as military-grade or "enhanced plastic." Only products designated by TI as military-grade meet military specifications. Buyers acknowledge and agree that any such use of TI products which TI has not designated as military-grade is solely at the Buyer's risk, and that they are solely responsible for compliance with all legal and regulatory requirements in connection with such use.

TI products are neither designed nor intended for use in automotive applications or environments unless the specific TI products are designated by TI as compliant with ISO/TS 16949 requirements. Buyers acknowledge and agree that, if they use any non-designated products in automotive applications, TI will not be responsible for any failure to meet such requirements.

Following are URLs where you can obtain information on other Texas Instruments products and application solutions:

<b>Products</b>		<b>Applications</b>	
Amplifiers	<a href="http://amplifier.ti.com">amplifier.ti.com</a>	Audio	<a href="http://www.ti.com/audio">www.ti.com/audio</a>
Data Converters	<a href="http://dataconverter.ti.com">dataconverter.ti.com</a>	Automotive	<a href="http://www.ti.com/automotive">www.ti.com/automotive</a>
DLP® Products	<a href="http://www.dlp.com">www.dlp.com</a>	Communications and Telecom	<a href="http://www.ti.com/communications">www.ti.com/communications</a>
DSP	<a href="http://dsp.ti.com">dsp.ti.com</a>	Computers and Peripherals	<a href="http://www.ti.com/computers">www.ti.com/computers</a>
Clocks and Timers	<a href="http://www.ti.com/clocks">www.ti.com/clocks</a>	Consumer Electronics	<a href="http://www.ti.com/consumer-apps">www.ti.com/consumer-apps</a>
Interface	<a href="http://interface.ti.com">interface.ti.com</a>	Energy	<a href="http://www.ti.com/energy">www.ti.com/energy</a>
Logic	<a href="http://logic.ti.com">logic.ti.com</a>	Industrial	<a href="http://www.ti.com/industrial">www.ti.com/industrial</a>
Power Mgmt	<a href="http://power.ti.com">power.ti.com</a>	Medical	<a href="http://www.ti.com/medical">www.ti.com/medical</a>
Microcontrollers	<a href="http://microcontroller.ti.com">microcontroller.ti.com</a>	Security	<a href="http://www.ti.com/security">www.ti.com/security</a>
RFID	<a href="http://www.ti-rfid.com">www.ti-rfid.com</a>	Space, Avionics & Defense	<a href="http://www.ti.com/space-avionics-defense">www.ti.com/space-avionics-defense</a>
RF/IF and ZigBee® Solutions	<a href="http://www.ti.com/lprf">www.ti.com/lprf</a>	Video and Imaging	<a href="http://www.ti.com/video">www.ti.com/video</a>
		Wireless	<a href="http://www.ti.com/wireless-apps">www.ti.com/wireless-apps</a>