

## DAC8x11 2-V to 5.5-V, 80- $\mu$ A, 14- and 16-Bit, Low-Power, Single-Channel, Digital-to-Analog Converters in SC70 Package

### 1 Features

- Relative Accuracy:
  - 1 LSB INL (DAC8311: 14-bit)
  - 4 LSB INL (DAC8411: 16-bit)
- microPower Operation: 80  $\mu$ A at 2 V
- Power-Down: 0.5  $\mu$ A at 5 V, 0.1  $\mu$ A at 2 V
- Wide Power Supply: 2 V to 5.5 V
- Power-On Reset to Zero Scale
- Straight Binary Data Format
- Low Power Serial Interface With Schmitt-Triggered Inputs: Up to 50 MHz
- On-Chip Output Buffer Amplifier, Rail-to-Rail Operation
- $\overline{\text{SYNC}}$  Interrupt Facility
- Extended Temperature Range  $-40^{\circ}\text{C}$  to  $125^{\circ}\text{C}$
- Pin-Compatible Family in a Tiny, 6-Pin SC70 Package

### 2 Applications

- Portable, Battery-Powered instruments
- Process Controls
- Digital Gain and Offset Adjustment
- Programmable Voltage and Current Sources

### 3 Description

The DAC8311 (14-bit) and DAC8411 (16-bit) devices are low-power, single-channel, voltage output digital-to-analog converters (DAC). They provide excellent linearity and minimize undesired code-to-code transient voltages while offering an easy upgrade path within a pin-compatible family. All devices use a versatile, 3-wire serial interface that operates at clock rates of up to 50 MHz and is compatible with standard SPI™, QSPI™, Microwire, and digital signal processor (DSP) interfaces.

All devices use an external power supply as a reference voltage to set the output range. The devices incorporate a power-on reset (POR) circuit that ensures the DAC output powers up at 0 V and remains there until a valid write to the device occurs. The DAC8311 and DAC8411 contain a power-down feature, accessed over the serial interface, that reduces current consumption of the device to 0.1  $\mu$ A at 2 V in power down mode. The low power consumption of these devices in normal operation makes it ideally suited for portable, battery-operated equipment. The power consumption is 0.55 mW at 5 V, reducing to 2.5  $\mu$ W in power-down mode.

These devices are pin-compatible with the [DAC5311](#), [DAC6311](#), and [DAC7311](#), offering an easy upgrade path from 8-, 10-, and 12-bit resolution to 14- and 16-bit. All devices are available in a small, 6-pin, SC70 package. This package offers a flexible, pin-compatible, and functionally-compatible drop-in solution within the family over an extended temperature range of  $-40^{\circ}\text{C}$  to  $125^{\circ}\text{C}$ .

**Simplified Schematic**

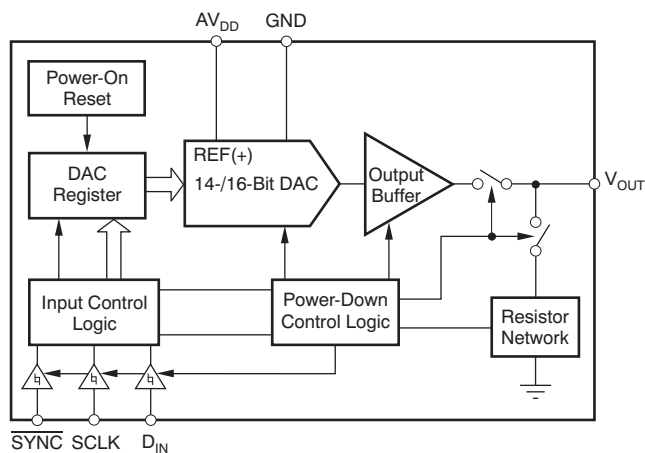

**Device Information<sup>(1)</sup>**

PART NUMBER	PACKAGE	BODY SIZE (NOM)
DAC8311	SC70 (6)	2.00 mm x 1.25 mm
DAC8411		

(1) For all available packages, see the orderable addendum at the end of the data sheet.



## Table of Contents

<b>1 Features</b> .....	<b>1</b>	8.3 Feature Description.....	<b>22</b>
<b>2 Applications</b> .....	<b>1</b>	8.4 Device Functional Modes.....	<b>24</b>
<b>3 Description</b> .....	<b>1</b>	8.5 Programming.....	<b>25</b>
<b>4 Revision History</b> .....	<b>2</b>	<b>9 Application and Implementation</b> .....	<b>27</b>
<b>5 Device Comparison</b> .....	<b>3</b>	9.1 Application Information.....	<b>27</b>
<b>6 Pin Configuration and Functions</b> .....	<b>3</b>	9.2 Typical Applications .....	<b>28</b>
<b>7 Specifications</b> .....	<b>4</b>	<b>10 Power Supply Recommendations</b> .....	<b>31</b>
7.1 Absolute Maximum Ratings .....	<b>4</b>	<b>11 Layout</b> .....	<b>32</b>
7.2 ESD Ratings.....	<b>4</b>	11.1 Layout Guidelines .....	<b>32</b>
7.3 Recommended Operating Conditions.....	<b>4</b>	11.2 Layout Example .....	<b>32</b>
7.4 Thermal Information .....	<b>4</b>	<b>12 Device and Documentation Support</b> .....	<b>33</b>
7.5 Electrical Characteristics.....	<b>5</b>	12.1 Related Links .....	<b>33</b>
7.6 Timing Requirements: 14-Bit .....	<b>7</b>	12.2 Community Resources.....	<b>33</b>
7.7 Timing Requirements: 16-Bit .....	<b>7</b>	12.3 Trademarks .....	<b>33</b>
7.8 Typical Characteristics .....	<b>9</b>	12.4 Electrostatic Discharge Caution.....	<b>33</b>
<b>8 Detailed Description</b> .....	<b>22</b>	12.5 Glossary .....	<b>33</b>
8.1 Overview .....	<b>22</b>	<b>13 Mechanical, Packaging, and Orderable Information</b> .....	<b>33</b>
8.2 Functional Block Diagram .....	<b>22</b>		

## 4 Revision History

NOTE: Page numbers for previous revisions may differ from page numbers in the current version.

<b>Changes from Revision B (May 2013) to Revision C</b>	<b>Page</b>
<ul style="list-style-type: none"> <li>Added <i>ESD Ratings</i> table, <i>Feature Description</i> section, <i>Device Functional Modes</i>, <i>Application and Implementation</i> section, <i>Power Supply Recommendations</i> section, <i>Layout</i> section, <i>Device and Documentation Support</i> section, and <i>Mechanical, Packaging, and Orderable Information</i> section .....</li> </ul>	<b>1</b>

<b>Changes from Revision A (August, 2011) to Revision B</b>	<b>Page</b>
<ul style="list-style-type: none"> <li>Changed all 1.8V to 2.0V throughout data sheet .....</li> <li>Deleted 1.8-V Typical Characteristics section .....</li> <li>Changed X-axis for <a href="#">Figure 35</a>.....</li> <li>Changed X-axis for <a href="#">Figure 36</a>.....</li> </ul>	<b>1</b> <b>9</b> <b>13</b> <b>13</b>

<b>Changes from Original (August, 2008) to Revision A</b>	<b>Page</b>
<ul style="list-style-type: none"> <li>Changed specifications and test conditions for input low voltage parameter.....</li> <li>Changed specifications and test conditions for input high voltage parameter .....</li> </ul>	<b>6</b> <b>6</b>

## 5 Device Comparison

**Table 1. Related Devices**

RELATED DEVICES	16-BIT	14-BIT	12-BIT	10-BIT	8-BIT
Pin and Function Compatible	DAC8411	DAC8311	DAC7311	DAC6311	DAC5311

**Table 2. Package Information**

PRODUCT	MAXIMUM RELATIVE ACCURACY (LSB)	MAXIMUM DIFFERENTIAL NONLINEARITY (LSB)
DAC8411	±8	±2
DAC8311	±4	±1

## 6 Pin Configuration and Functions

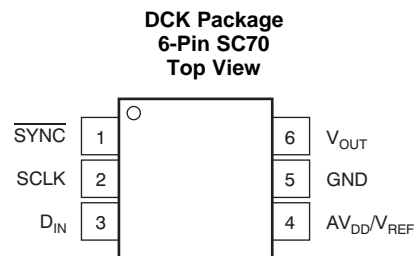

### Pin Functions

PIN		I/O	DESCRIPTION
NAME	NO.		
$AV_{DD}/V_{REF}$	4	I	Power Supply Input, +2 V to +5.5 V.
$D_{IN}$	3	I	Serial Data Input. Data is clocked into the 24-bit (DAC8411) or 16-bit (DAC8311) input shift register on the falling edge of the serial clock input.
GND	5	—	Ground reference point for all circuitry on the part.
SCLK	2	I	Serial Clock Input. Data can be transferred at rates up to 50 MHz.
$\overline{SYNC}$	1	I	Level-triggered control input (active low). This is the frame synchronization signal for the input data. When $\overline{SYNC}$ goes low, it enables the input shift register and data are transferred in on the falling edges of the following clocks. The DAC is updated following the 24th (DAC8411) or 16th (DAC8311) clock cycle, unless $\overline{SYNC}$ is taken high before this edge, in which case the rising edge of $\overline{SYNC}$ acts as an interrupt and the write sequence is ignored by the DAC8x11. Refer to the <a href="#">DAC8311 and DAC8411 <math>\overline{SYNC}</math> Interrupt</a> sections for more details.
$V_{OUT}$	6	O	Analog output voltage from DAC. The output amplifier has rail-to-rail operation.

## 7 Specifications

### 7.1 Absolute Maximum Ratings

over operating free-air temperature range (unless otherwise noted)<sup>(1)</sup>

		MIN	MAX	UNIT
Voltage	AV <sub>DD</sub> to GND	-0.3	6	V
	Digital input voltage to GND	-0.3	AV <sub>DD</sub> +0.3	V
	V <sub>OUT</sub> to GND	-0.3	AV <sub>DD</sub> +0.3	V
Temperature	Junction, T <sub>J</sub> max		150	°C
	Storage, T <sub>stg</sub>	-65	150	°C

(1) Stresses beyond those listed under *Absolute Maximum Ratings* may cause permanent damage to the device. These are stress ratings only, which do not imply functional operation of the device at these or any other conditions beyond those indicated under *Recommended Operating Conditions*. Exposure to absolute-maximum-rated conditions for extended periods may affect device reliability.

### 7.2 ESD Ratings

		VALUE	UNIT
V <sub>(ESD)</sub> Electrostatic discharge	Human-body model (HBM), per ANSI/ESDA/JEDEC JS-001 <sup>(1)</sup>	±1000	V
	Charged-device model (CDM), per JEDEC specification JESD22-C101 <sup>(2)</sup>	±500	

(1) JEDEC document JEP155 states that 500-V HBM allows safe manufacturing with a standard ESD control process.

(2) JEDEC document JEP157 states that 250-V CDM allows safe manufacturing with a standard ESD control process.

### 7.3 Recommended Operating Conditions

over operating free-air temperature range (unless otherwise noted)

		MIN	NOM	MAX	UNIT
T <sub>A</sub>	Operating temperature	-40		+125	°C
AV <sub>DD</sub>	Supply voltage	2.0		+5.5	V

### 7.4 Thermal Information

THERMAL METRIC <sup>(1)</sup>		DAC8x11	UNIT
		DCK (SC70)	
		6 PINS	
R <sub>θJA</sub>	Junction-to-ambient thermal resistance	216.4	°C/W
R <sub>θJC(top)</sub>	Junction-to-case (top) thermal resistance	52.1	°C/W
R <sub>θJB</sub>	Junction-to-board thermal resistance	65.9	°C/W
ψ <sub>JT</sub>	Junction-to-top characterization parameter	1.3	°C/W
ψ <sub>JB</sub>	Junction-to-board characterization parameter	65.2	°C/W
R <sub>θJC(bot)</sub>	Junction-to-case (bottom) thermal resistance	N/A	°C/W

(1) For more information about traditional and new thermal metrics, see the *Semiconductor and IC Package Thermal Metrics* application report, [SPRA953](#).

## 7.5 Electrical Characteristics

at  $AV_{DD} = 2\text{ V}$  to  $5.5\text{ V}$ ,  $R_L = 2\text{ k}\Omega$  to GND, and  $C_L = 200\text{ pF}$  to GND, and  $T_A = -40^\circ\text{C}$  to  $+125^\circ\text{C}$  unless otherwise noted.

PARAMETER	TEST CONDITIONS	DAC8411, DAC8311			UNIT	
		MIN	TYP	MAX		
<b>STATIC PERFORMANCE<sup>(1)</sup></b>						
DAC8411	Resolution	16			Bits	
	Relative accuracy	Measured by the line passing through codes 485 and 64714	3.6 V to 5 V	$\pm 4$	$\pm 8$	LSB
			2 V to 3.6 V	$\pm 4$	$\pm 12$	
	Differential nonlinearity	$\pm 0.5$			$\pm 2$	LSB
DAC8311	Resolution	14			Bits	
	Relative accuracy	Measured by the line passing through codes 120 and 16200	$\pm 1$		$\pm 4$	LSB
			$\pm 0.125$		$\pm 1$	LSB
Offset error	Measured by the line passing through two codes <sup>(2)</sup>	$\pm 0.05$		$\pm 4$	mV	
Offset error drift		3			$\mu\text{V}/^\circ\text{C}$	
Zero code error	All zeros loaded to the DAC register	0.2			mV	
Full-scale error	All ones loaded to DAC register	0.04		0.2	% of FSR	
Gain error		0.05		$\pm 0.15$	% of FSR	
Gain temperature coefficient	$AV_{DD} = 5\text{ V}$	$\pm 0.5$			ppm of FSR/ $^\circ\text{C}$	
	$AV_{DD} = 2\text{ V}$	$\pm 1.5$				
<b>OUTPUT CHARACTERISTICS</b>						
Output voltage range		0		$AV_{DD}$	V	
Output voltage settling time <sup>(3)</sup>	$R_L = 2\text{ k}\Omega$ , $C_L = 200\text{ pF}$ , $AV_{DD} = 5\text{ V}$ , 1/4 scale to 3/4 scale	6		10	$\mu\text{s}$	
	$R_L = 2\text{ M}\Omega$ , $C_L = 470\text{ pF}$	12			$\mu\text{s}$	
Slew rate		0.7			V/ $\mu\text{s}$	
Capacitive load stability	$R_L = \infty$	470			pF	
	$R_L = 2\text{ k}\Omega$	1000			pF	
Code change glitch impulse	1LSB change around major carry	0.5			nV-s	
Digital feedthrough		0.5			nV-s	
Power-on glitch impulse	$R_L = 2\text{ k}\Omega$ , $C_L = 200\text{ pF}$ , $AV_{DD} = 5\text{ V}$	17			mV	
DC output impedance		0.5			$\Omega$	
Short-circuit current	$AV_{DD} = 5\text{ V}$	50			mA	
	$AV_{DD} = 3\text{ V}$	20			mA	
Power-up time	Coming out of power-down mode	50			$\mu\text{s}$	
<b>AC PERFORMANCE</b>						
SNR	$T_A = 25^\circ\text{C}$ , BW = 20 kHz, 16-bit level, $AV_{DD} = 5\text{ V}$ , $f_{OUT} = 1\text{ kHz}$ , 1st 19 harmonics removed for SNR calculation	88			dB	
THD		-66			dB	
SFDR		66			dB	
SINAD		66			dB	
DAC output noise density <sup>(4)</sup>	$T_A = 25^\circ\text{C}$ , at zero-scale input, $f_{OUT} = 1\text{ kHz}$ , $AV_{DD} = 5\text{ V}$	17			$\text{nV}/\sqrt{\text{Hz}}$	
	$T_A = 25^\circ\text{C}$ , at mid-code input, $f_{OUT} = 1\text{ kHz}$ , $AV_{DD} = 5\text{ V}$	110			$\text{nV}/\sqrt{\text{Hz}}$	
DAC output noise <sup>(5)</sup>	$T_A = 25^\circ\text{C}$ , at mid-code input, 0.1 Hz to 10 Hz, $AV_{DD} = 5\text{ V}$	3			$\mu\text{V}_{pp}$	

(1) Linearity calculated using a reduced code range of 485 to 64714 for 16-bit, and 120 to 16200 for 14-bit, output unloaded.

(2) Straight line passing through codes 485 and 64714 for 16-bit, and 120 and 16200 for 14-bit, output unloaded.

(3) Specified by design and characterization, not production tested.

(4) For more details, see [Figure 33](#).

(5) For more details, see [Figure 34](#).

**Electrical Characteristics (continued)**

 at  $AV_{DD} = 2\text{ V to }5.5\text{ V}$ ,  $R_L = 2\text{ k}\Omega$  to GND, and  $C_L = 200\text{ pF}$  to GND, and  $T_A = -40^\circ\text{C to }+125^\circ\text{C}$  unless otherwise noted.

PARAMETER		TEST CONDITIONS		DAC8411, DAC8311			UNIT	
				MIN	TYP	MAX		
<b>LOGIC INPUTS<sup>(3)</sup></b>								
Input current						$\pm 1$	$\mu\text{A}$	
$V_{INL}$ , input low voltage		$AV_{DD} = 2.7\text{ V to }5.5\text{ V}$				$0.3 \times AV_{DD}$	V	
		$AV_{DD} = 2\text{ V to }2.7\text{ V}$				$0.1 \times AV_{DD}$	V	
$V_{INH}$ , input high voltage		$AV_{DD} = 2.7\text{ V to }5.5\text{ V}$				$0.7 \times AV_{DD}$	V	
		$AV_{DD} = 2\text{ V to }2.7\text{ V}$				$0.9 \times AV_{DD}$	V	
Pin capacitance					1.5	3	pF	
<b>POWER REQUIREMENTS</b>								
$AV_{DD}$				2		5.5	V	
$I_{DD}$	Normal mode	$V_{INH} = AV_{DD}$ and $V_{INL} = \text{GND}$ , at mid-scale code <sup>(6)</sup>		$AV_{DD} = 3.6\text{ V to }5.5\text{ V}$		110	160	$\mu\text{A}$
				$AV_{DD} = 2.7\text{ V to }3.6\text{ V}$		95	150	
				$AV_{DD} = 2\text{ V to }2.7\text{ V}$		80	140	
	All power-down mode	$V_{INH} = AV_{DD}$ and $V_{INL} = \text{GND}$ , at mid-scale code <sup>(6)</sup>		$AV_{DD} = 3.6\text{ V to }5.5\text{ V}$		0.5	3.5	$\mu\text{A}$
				$AV_{DD} = 2.7\text{ V to }3.6\text{ V}$		0.4	3.0	
				$AV_{DD} = 2\text{ V to }2.7\text{ V}$		0.1	2.0	
Power dissipation	Normal mode	$V_{INH} = AV_{DD}$ and $V_{INL} = \text{GND}$ , at mid-scale code <sup>(6)</sup>		$AV_{DD} = 3.6\text{ V to }5.5\text{ V}$		0.55	0.88	mW
				$AV_{DD} = 2.7\text{ V to }3.6\text{ V}$		0.25	0.54	
				$AV_{DD} = 2\text{ V to }2.7\text{ V}$		0.14	0.38	
	All power-down mode	$V_{INH} = AV_{DD}$ and $V_{INL} = \text{GND}$ , at mid-scale code <sup>(6)</sup>		$AV_{DD} = 3.6\text{ V to }5.5\text{ V}$		2.50	19.2	$\mu\text{W}$
				$AV_{DD} = 2.7\text{ V to }3.6\text{ V}$		1.08	10.8	
				$AV_{DD} = 2\text{ V to }2.7\text{ V}$		0.72	8.1	

 (6) For more details, see [Figure 14](#) and [Figure 55](#).

## 7.6 Timing Requirements: 14-Bit

All specifications at  $-40^{\circ}\text{C}$  to  $125^{\circ}\text{C}$ , and  $\text{AV}_{\text{DD}} = 2\text{ V}$  to  $5.5\text{ V}$ , unless otherwise noted. <sup>(1)</sup> <sup>(2)</sup>

PARAMETER		TEST CONDITIONS	MIN	TYP	MAX	UNIT
$f_{(\text{SCLK})}$	Serial clock frequency	$\text{AV}_{\text{DD}} = 2.0\text{ V}$ to $3.6\text{ V}$			20	MHz
		$\text{AV}_{\text{DD}} = 3.6\text{ V}$ to $5.5\text{ V}$			50	
$t_1$	SCLK cycle time	$\text{AV}_{\text{DD}} = 2\text{ V}$ to $3.6\text{ V}$	50			ns
		$\text{AV}_{\text{DD}} = 3.6\text{ V}$ to $5.5\text{ V}$	20			
$t_2$	SCLK high time	$\text{AV}_{\text{DD}} = 2\text{ V}$ to $3.6\text{ V}$	25			ns
		$\text{AV}_{\text{DD}} = 3.6\text{ V}$ to $5.5\text{ V}$	10			
$t_3$	SCLK low time	$\text{AV}_{\text{DD}} = 2\text{ V}$ to $3.6\text{ V}$	25			ns
		$\text{AV}_{\text{DD}} = 3.6\text{ V}$ to $5.5\text{ V}$	10			
$t_4$	$\overline{\text{SYNC}}$ to SCLK rising edge setup time	$\text{AV}_{\text{DD}} = 2\text{ V}$ to $3.6\text{ V}$	0			ns
		$\text{AV}_{\text{DD}} = 3.6\text{ V}$ to $5.5\text{ V}$	0			
$t_5$	Data setup time	$\text{AV}_{\text{DD}} = 2\text{ V}$ to $3.6\text{ V}$	5			ns
		$\text{AV}_{\text{DD}} = 3.6\text{ V}$ to $5.5\text{ V}$	5			
$t_6$	Data hold time	$\text{AV}_{\text{DD}} = 2\text{ V}$ to $3.6\text{ V}$	4.5			ns
		$\text{AV}_{\text{DD}} = 3.6\text{ V}$ to $5.5\text{ V}$	4.5			
$t_7$	SCLK falling edge to $\overline{\text{SYNC}}$ rising edge	$\text{AV}_{\text{DD}} = 2\text{ V}$ to $3.6\text{ V}$	0			ns
		$\text{AV}_{\text{DD}} = 3.6\text{ V}$ to $5.5\text{ V}$	0			
$t_8$	Minimum $\overline{\text{SYNC}}$ high time	$\text{AV}_{\text{DD}} = 2\text{ V}$ to $3.6\text{ V}$	50			ns
		$\text{AV}_{\text{DD}} = 3.6\text{ V}$ to $5.5\text{ V}$	20			
$t_9$	16th SCLK falling edge to $\overline{\text{SYNC}}$ falling edge	$\text{AV}_{\text{DD}} = 2\text{ V}$ to $3.6\text{ V}$	100			ns
		$\text{AV}_{\text{DD}} = 3.6\text{ V}$ to $5.5\text{ V}$	100			
$t_{10}$	$\overline{\text{SYNC}}$ rising edge to 16th SCLK falling edge (for successful $\overline{\text{SYNC}}$ interrupt)	$\text{AV}_{\text{DD}} = 2\text{ V}$ to $3.6\text{ V}$	15			ns
		$\text{AV}_{\text{DD}} = 3.6\text{ V}$ to $5.5\text{ V}$	15			

(1) All input signals are specified with  $t_R = t_F = 3\text{ ns}$  (10% to 90% of  $\text{AV}_{\text{DD}}$ ) and timed from a voltage level of  $(V_{\text{IL}} + V_{\text{IH}})/2$ .

(2) See [Figure 1](#) timing diagram.

## 7.7 Timing Requirements: 16-Bit

All specifications at  $-40^{\circ}\text{C}$  to  $125^{\circ}\text{C}$ , and  $\text{AV}_{\text{DD}} = 2\text{ V}$  to  $5.5\text{ V}$ , unless otherwise noted. <sup>(1)</sup> <sup>(2)</sup>

PARAMETER		TEST CONDITIONS	MIN	TYP	MAX	UNIT
$f(\text{SCLK})$	Serial clock frequency	$\text{AV}_{\text{DD}} = 2.0\text{ V}$ to $3.6\text{ V}$			20	MHz
		$\text{AV}_{\text{DD}} = 3.6\text{ V}$ to $5.5\text{ V}$			50	
$t_1$	SCLK cycle time	$\text{AV}_{\text{DD}} = 2\text{ V}$ to $3.6\text{ V}$	50			ns
		$\text{AV}_{\text{DD}} = 3.6\text{ V}$ to $5.5\text{ V}$	20			
$t_2$	SCLK high time	$\text{AV}_{\text{DD}} = 2\text{ V}$ to $3.6\text{ V}$	25			ns
		$\text{AV}_{\text{DD}} = 3.6\text{ V}$ to $5.5\text{ V}$	10			
$t_3$	SCLK low time	$\text{AV}_{\text{DD}} = 2\text{ V}$ to $3.6\text{ V}$	25			ns
		$\text{AV}_{\text{DD}} = 3.6\text{ V}$ to $5.5\text{ V}$	10			
$t_4$	$\overline{\text{SYNC}}$ to SCLK rising edge setup time	$\text{AV}_{\text{DD}} = 2\text{ V}$ to $3.6\text{ V}$	0			ns
		$\text{AV}_{\text{DD}} = 3.6\text{ V}$ to $5.5\text{ V}$	0			
$t_5$	Data setup time	$\text{AV}_{\text{DD}} = 2\text{ V}$ to $3.6\text{ V}$	5			ns
		$\text{AV}_{\text{DD}} = 3.6\text{ V}$ to $5.5\text{ V}$	5			
$t_6$	Data hold time	$\text{AV}_{\text{DD}} = 2\text{ V}$ to $3.6\text{ V}$	4.5			ns
		$\text{AV}_{\text{DD}} = 3.6\text{ V}$ to $5.5\text{ V}$	4.5			
$t_7$	SCLK falling edge to $\overline{\text{SYNC}}$ rising edge	$\text{AV}_{\text{DD}} = 2\text{ V}$ to $3.6\text{ V}$	0			ns
		$\text{AV}_{\text{DD}} = 3.6\text{ V}$ to $5.5\text{ V}$	0			

(1) All input signals are specified with  $t_R = t_F = 3\text{ ns}$  (10% to 90% of  $\text{AV}_{\text{DD}}$ ) and timed from a voltage level of  $(V_{\text{IL}} + V_{\text{IH}})/2$ .

(2) See [Figure 2](#) timing diagram.

**Timing Requirements: 16-Bit (continued)**

 All specifications at  $-40^{\circ}\text{C}$  to  $125^{\circ}\text{C}$ , and  $\text{AV}_{\text{DD}} = 2\text{ V}$  to  $5.5\text{ V}$ , unless otherwise noted.<sup>(1) (2)</sup>

PARAMETER	TEST CONDITIONS	MIN	TYP	MAX	UNIT
$t_8$	Minimum $\overline{\text{SYNC}}$ high time	$\text{AV}_{\text{DD}} = 2\text{ V}$ to $3.6\text{ V}$	50		ns
		$\text{AV}_{\text{DD}} = 3.6\text{ V}$ to $5.5\text{ V}$	20		
$t_9$	24th SCLK falling edge to $\overline{\text{SYNC}}$ falling edge	$\text{AV}_{\text{DD}} = 2\text{ V}$ to $3.6\text{ V}$	100		ns
		$\text{AV}_{\text{DD}} = 3.6\text{ V}$ to $5.5\text{ V}$	100		
$t_{10}$	$\overline{\text{SYNC}}$ rising edge to 24th SCLK falling edge (for successful SYNC interrupt)	$\text{AV}_{\text{DD}} = 2\text{ V}$ to $3.6\text{ V}$	15		ns
		$\text{AV}_{\text{DD}} = 3.6\text{ V}$ to $5.5\text{ V}$	15		

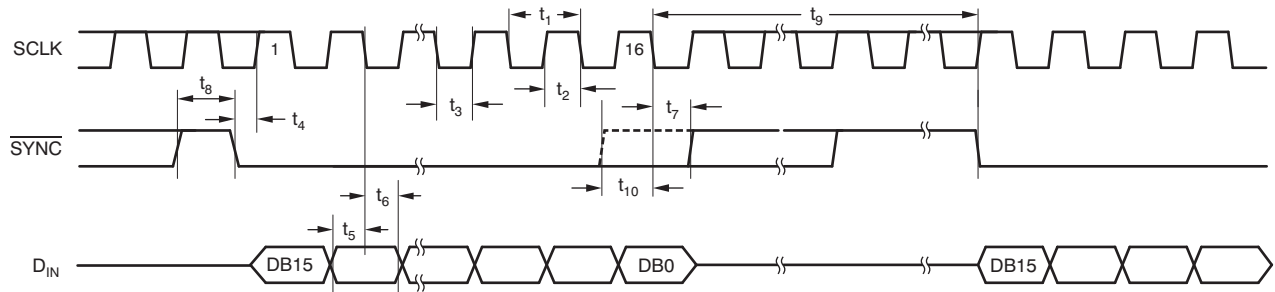
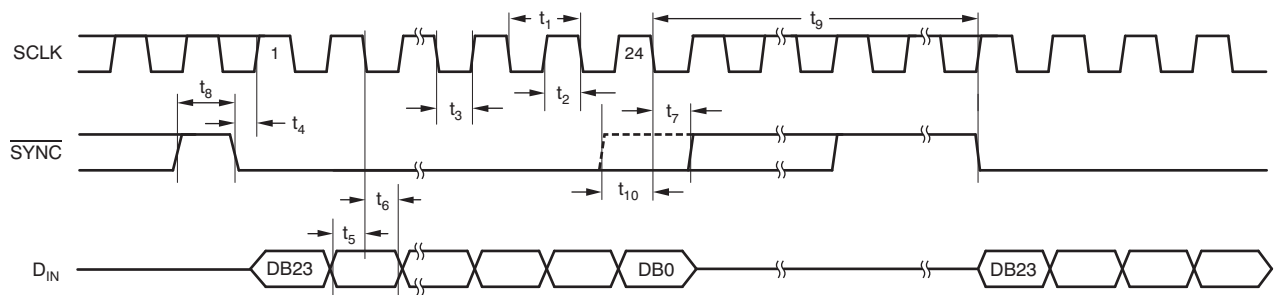
**Figure 1. Serial Write Operation: 14-Bit (DAC8311)**

**Figure 2. Serial Write Operation: 16-Bit (DAC8411)**



## 7.8 Typical Characteristics

### 7.8.1 Typical Characteristics: $AV_{DD} = 5\text{ V}$

at  $T_A = 25^\circ\text{C}$ ,  $AV_{DD} = 5\text{ V}$ , and DAC loaded with mid-scale code, unless otherwise noted.

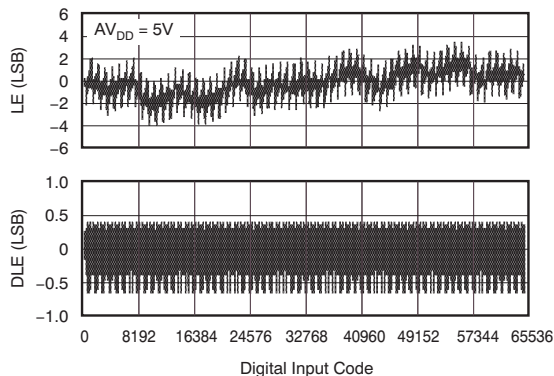

Figure 3. DAC8411 16-Bit Linearity Error and Differential Linearity Error vs Code ( $-40^\circ\text{C}$ )

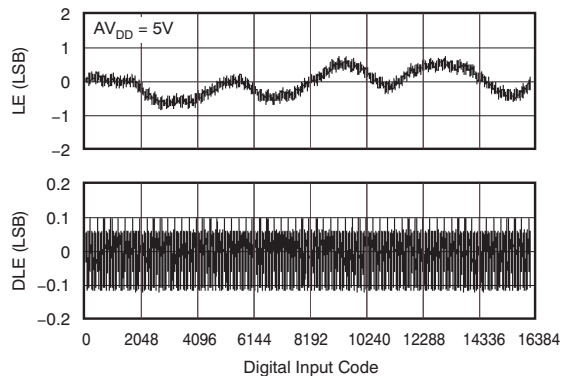

Figure 4. DAC8311 14-Bit Linearity Error and Differential Linearity Error vs Code ( $-40^\circ\text{C}$ )

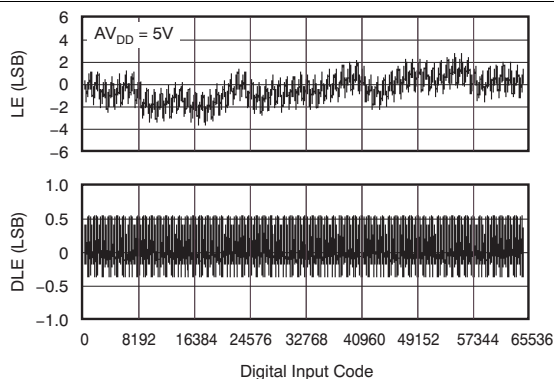

Figure 5. DAC8411 16-Bit Linearity Error and Differential Linearity Error vs Code ( $25^\circ\text{C}$ )

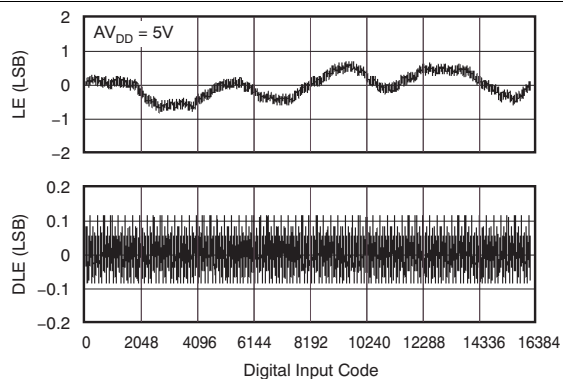

Figure 6. DAC8311 14-Bit Linearity Error and Differential Linearity Error vs Code ( $25^\circ\text{C}$ )

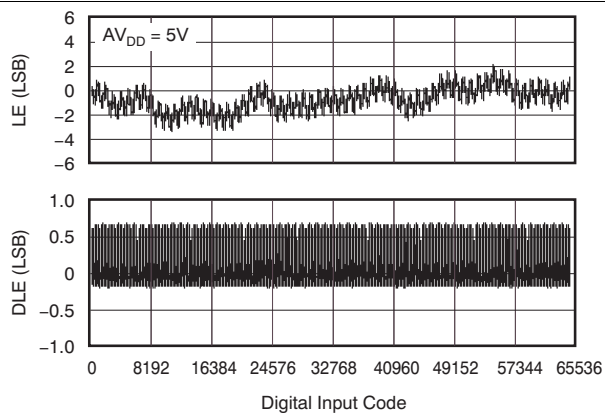

Figure 7. DAC8411 16-Bit Linearity Error and Differential Linearity Error vs Code ( $125^\circ\text{C}$ )

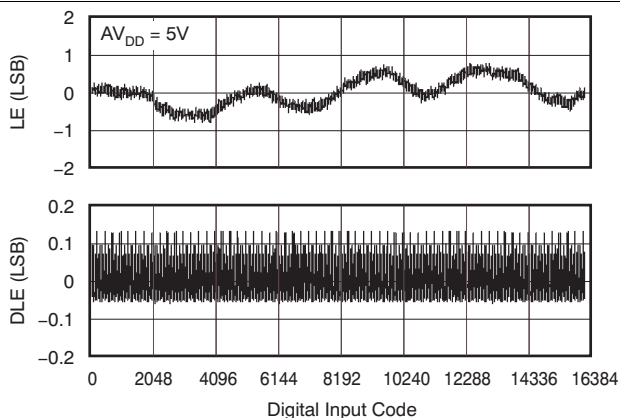
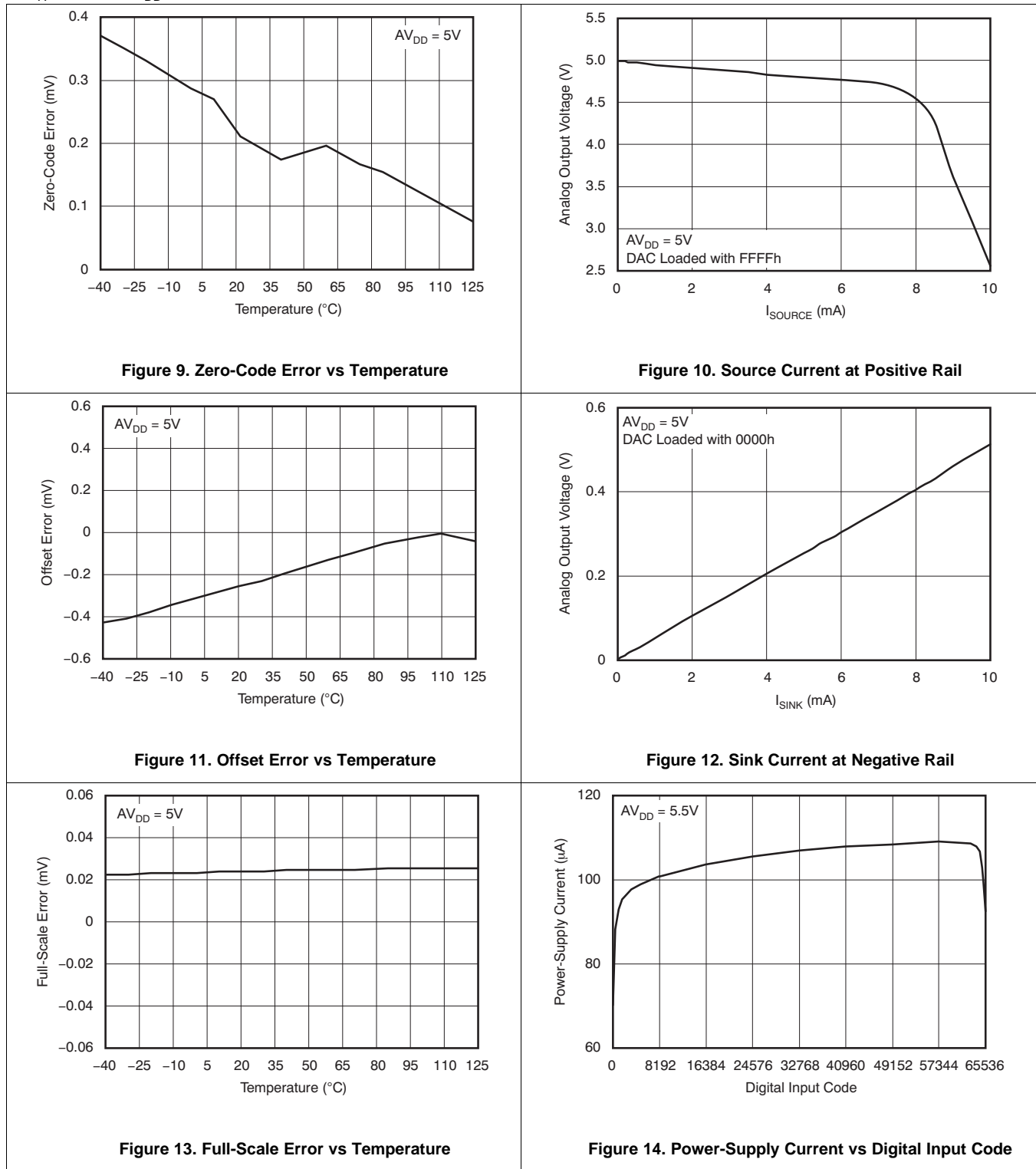

Figure 8. DAC8311 14-Bit Linearity Error and Differential Linearity Error vs Code ( $125^\circ\text{C}$ )

**Typical Characteristics:  $AV_{DD} = 5\text{ V}$  (continued)**

at  $T_A = 25^\circ\text{C}$ ,  $AV_{DD} = 5\text{ V}$ , and DAC loaded with mid-scale code, unless otherwise noted.



Typical Characteristics: AV<sub>DD</sub> = 5 V (continued)

at T<sub>A</sub> = 25°C, AV<sub>DD</sub> = 5 V, and DAC loaded with mid-scale code, unless otherwise noted.

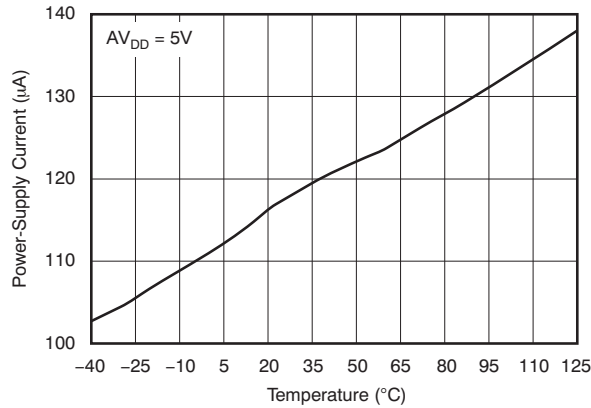

Figure 15. Power-Supply Current vs Temperature

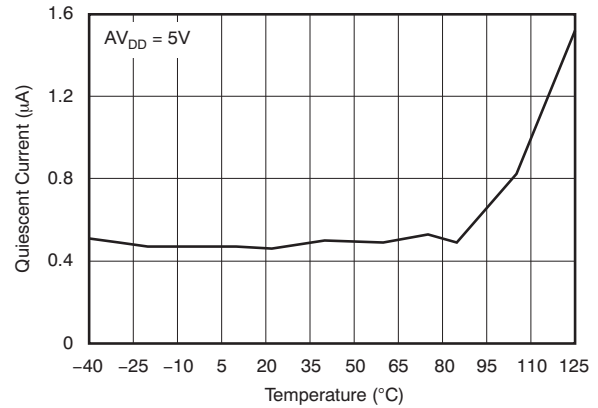

Figure 16. Power-Down Current vs Temperature

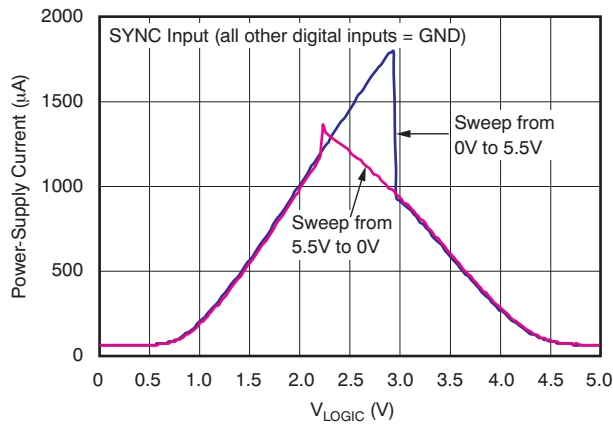

Figure 17. Power-Supply Current vs Logic Input Voltage

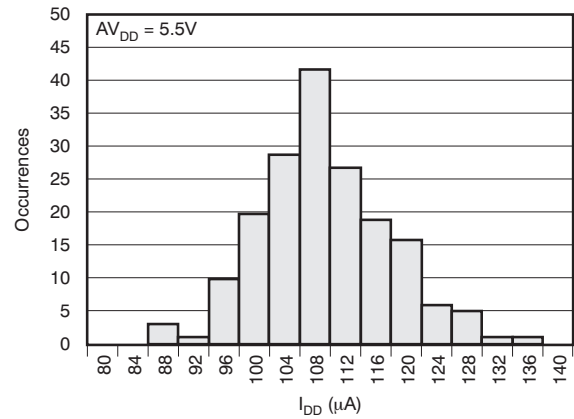

Figure 18. Power-Supply Current Histogram

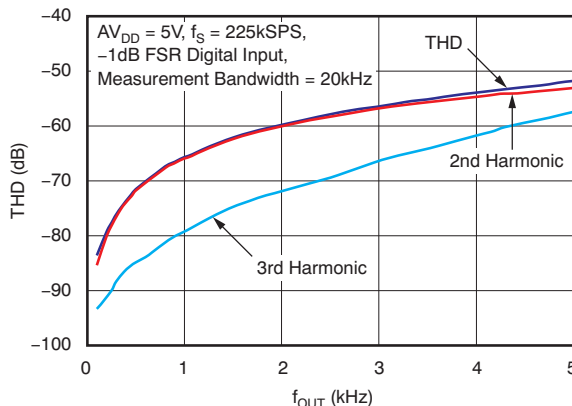

Figure 19. Total Harmonic Distortion vs Output Frequency

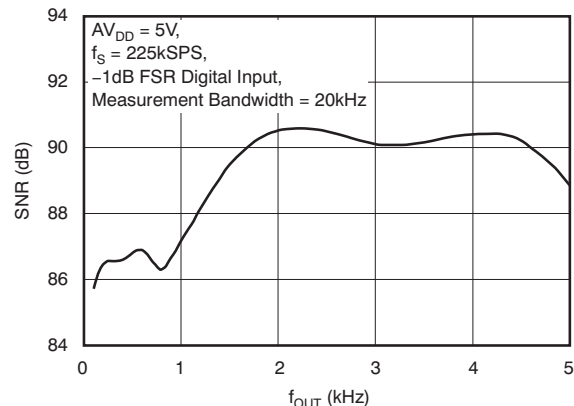
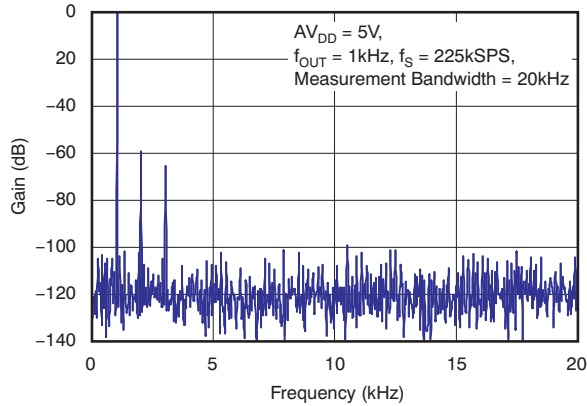

Figure 20. Signal-to-Noise Ratio vs Output Frequency

**Typical Characteristics:  $AV_{DD} = 5\text{ V}$  (continued)**

at  $T_A = 25^\circ\text{C}$ ,  $AV_{DD} = 5\text{ V}$ , and DAC loaded with mid-scale code, unless otherwise noted.



**Figure 21. Power Spectral Density**

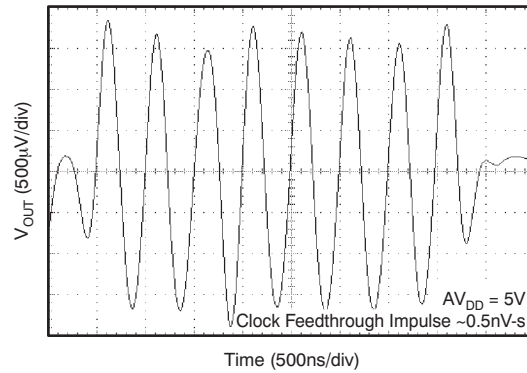

**Figure 22. Clock Feedthrough 5 V, 2 mHz, Midscale**

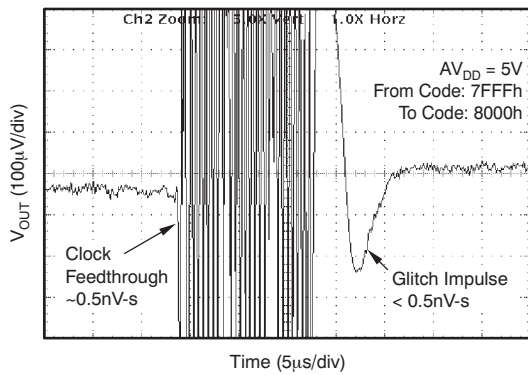

**Figure 23. Glitch Energy 5 V, 16-Bit, 1LSB Step, Rising Edge**

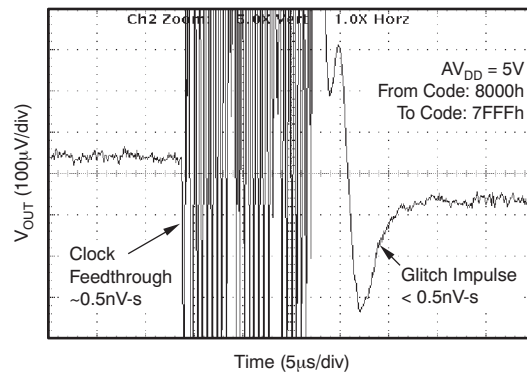

**Figure 24. Glitch Energy 5 V, 16-Bit, 1LSB Step, Falling Edge**

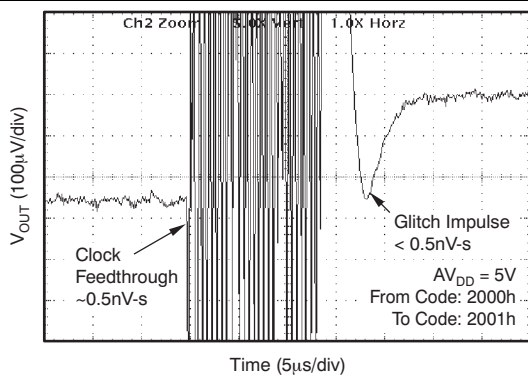

**Figure 25. Glitch Energy 5 V, 14-Bit, 1LSB Step, Rising Edge**

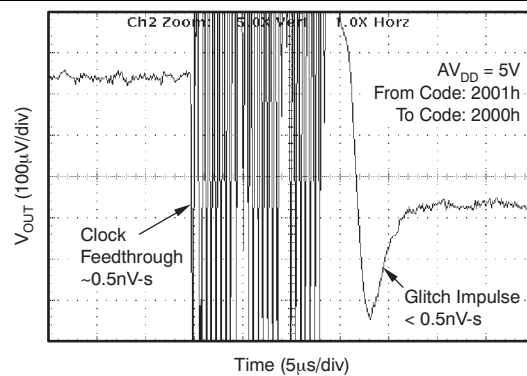

**Figure 26. Glitch Energy 5 V, 14-Bit, 1LSB Step, Falling Edge**

Typical Characteristics:  $AV_{DD} = 5\text{ V}$  (continued)

at  $T_A = 25^\circ\text{C}$ ,  $AV_{DD} = 5\text{ V}$ , and DAC loaded with mid-scale code, unless otherwise noted.

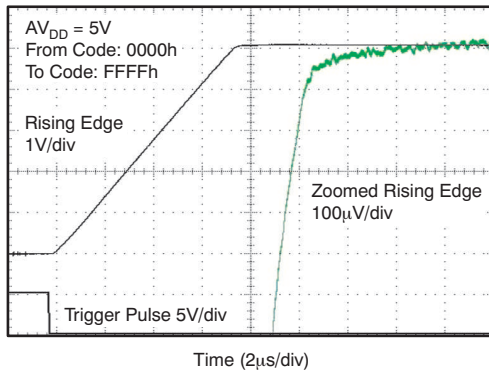

Figure 27. Full-Scale Settling Time 5-V Rising Edge

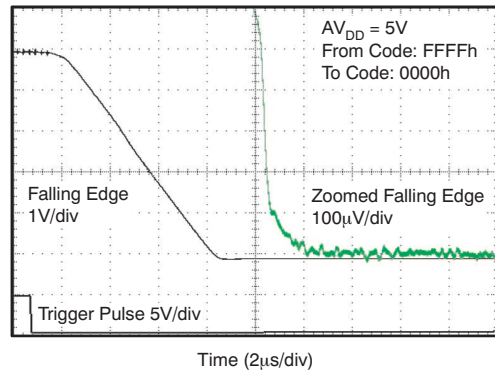

Figure 28. Full-Scale Settling Time 5-V Falling Edge

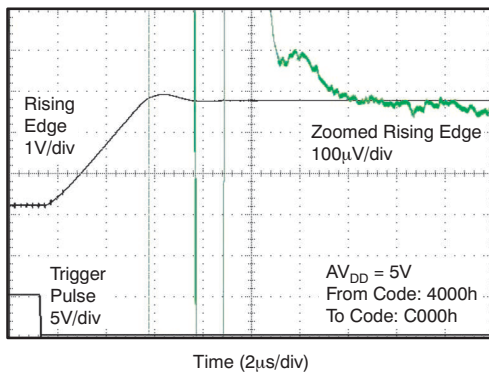

Figure 29. Half-Scale Settling Time 5-V Rising Edge

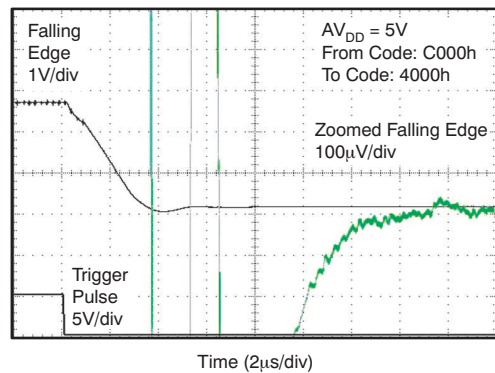

Figure 30. Half-Scale Settling Time 5-V Falling Edge

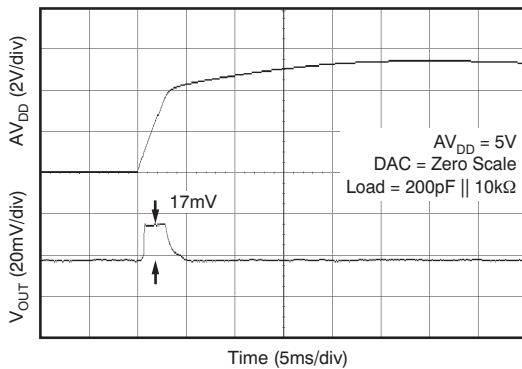

Figure 31. Power-On Reset to 0 V Power-On Glitch

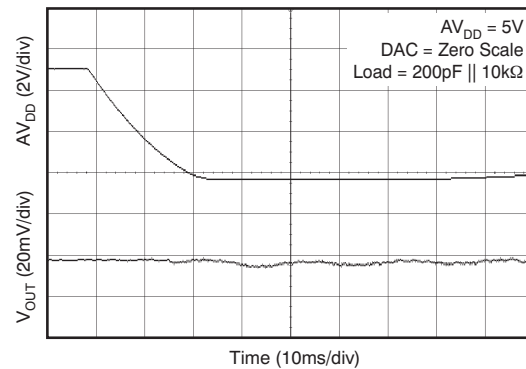

Figure 32. Power-Off Glitch

Typical Characteristics:  $AV_{DD} = 5\text{ V}$  (continued)

at  $T_A = 25^\circ\text{C}$ ,  $AV_{DD} = 5\text{ V}$ , and DAC loaded with mid-scale code, unless otherwise noted.

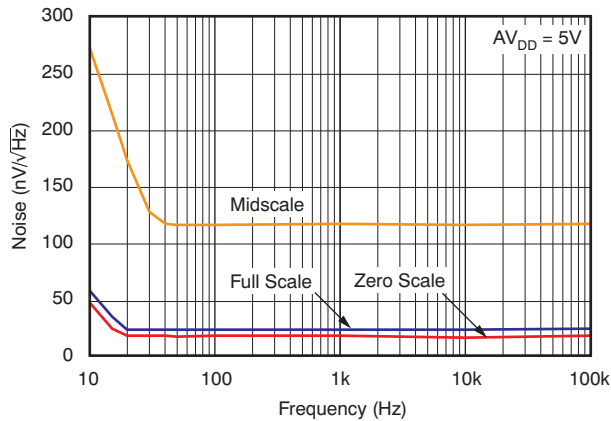

Figure 33. DAC Output Noise Density vs Frequency

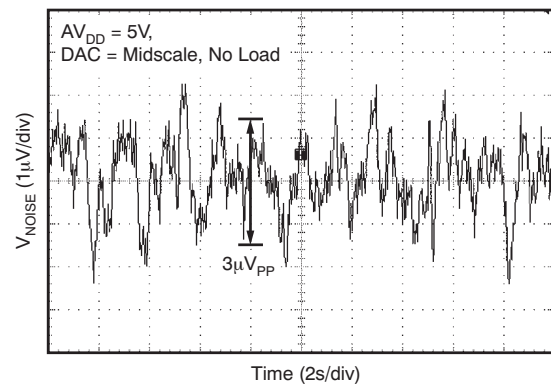

Figure 34. DAC Output Noise 0.1 Hz to 10 Hz Bandwidth

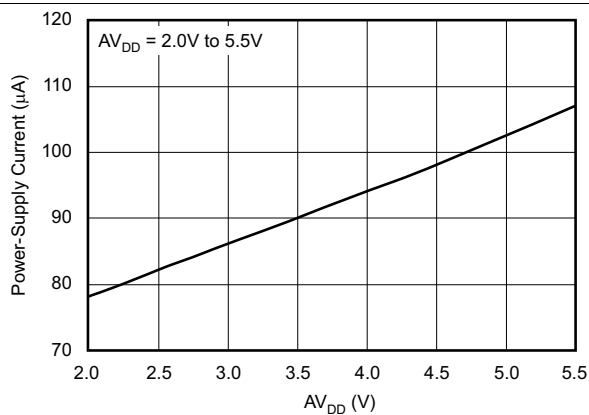

Figure 35. Power-Supply Current vs Power-Supply Voltage

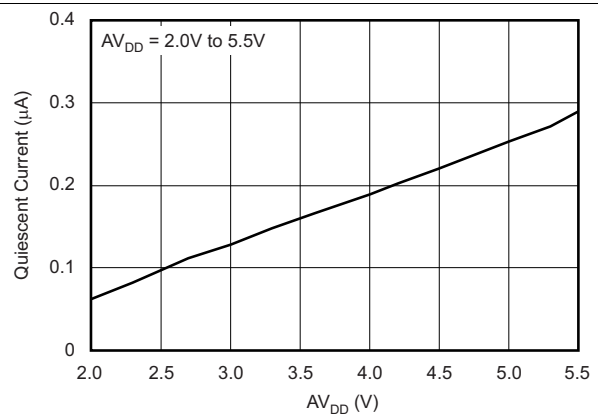

Figure 36. Power-Down Current vs Power-Supply Voltage

7.8.2 Typical Characteristics:  $AV_{DD} = 3.6\text{ V}$

at  $T_A = 25^\circ\text{C}$ , and  $AV_{DD} = 3.6\text{ V}$ , unless otherwise noted.

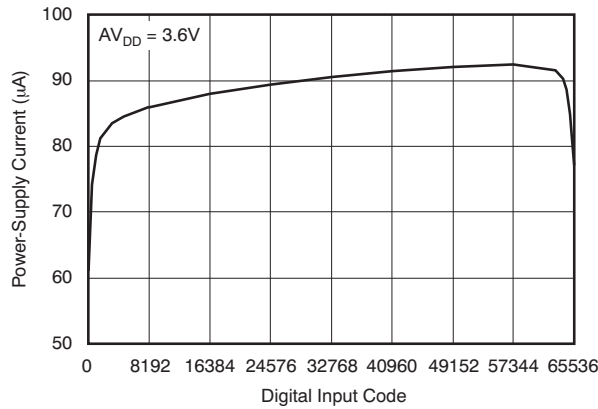

Figure 37. Power-Supply Current vs Digital Input Code

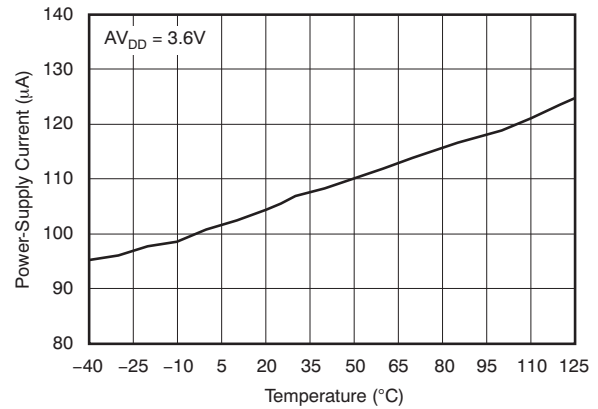

Figure 38. Power-Supply Current vs Temperature

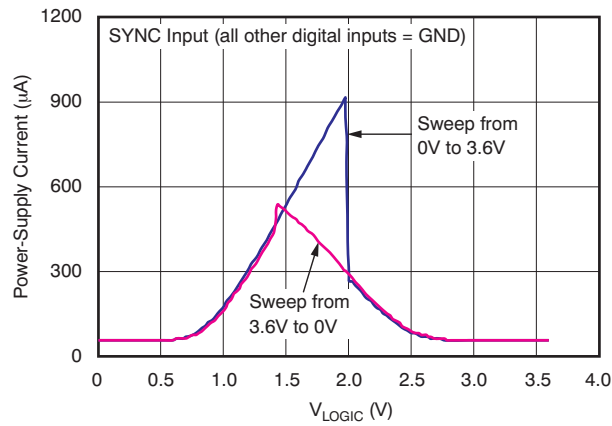

Figure 39. Power-Supply Current vs Logic Input Voltage

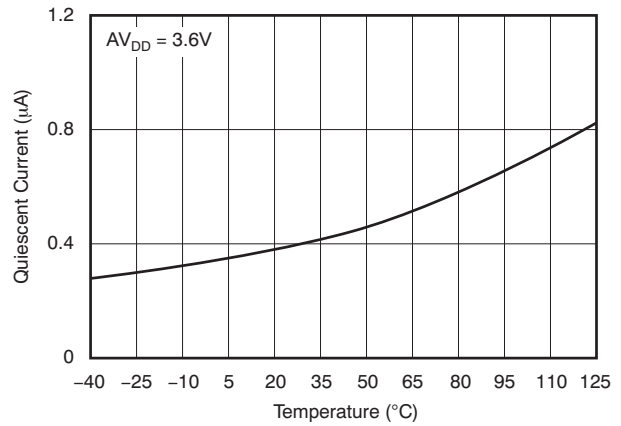

Figure 40. Power-Down Current vs Temperature

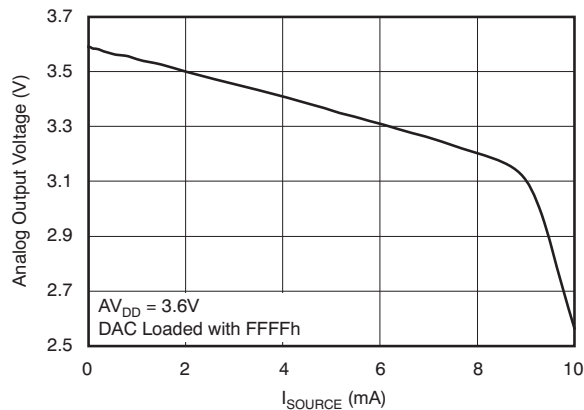

Figure 41. Source Current at Positive Rail

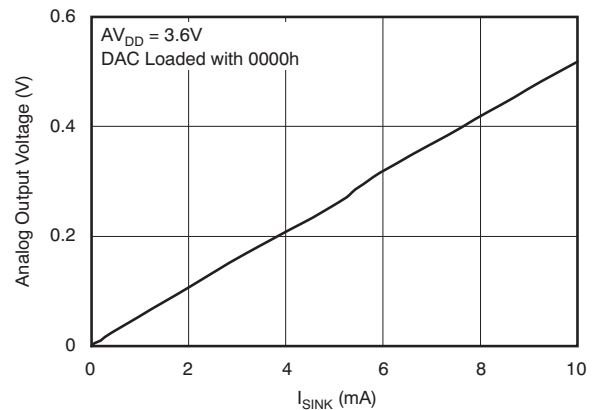

Figure 42. Sink Current at Negative Rail

DAC8311, DAC8411

SBAS439C –AUGUST 2008–REVISED JULY 2015

www.ti.com

Typical Characteristics:  $AV_{DD} = 3.6\text{ V}$  (continued)

at  $T_A = 25^\circ\text{C}$ , and  $AV_{DD} = 3.6\text{ V}$ , unless otherwise noted.

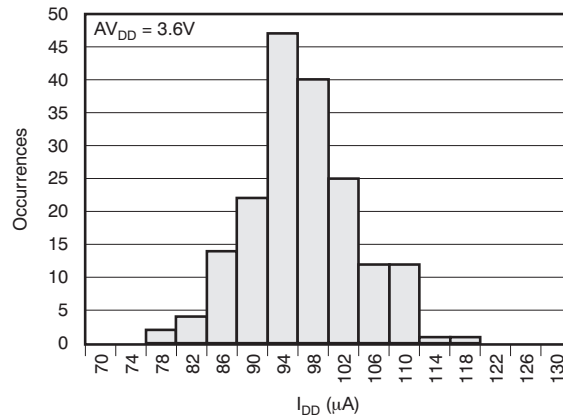

Figure 43. Power-Supply Current Histogram

7.8.3 Typical Characteristics:  $AV_{DD} = 2.7\text{ V}$

at  $T_A = 25^\circ\text{C}$ , and  $AV_{DD} = 2.7\text{ V}$ , unless otherwise noted.

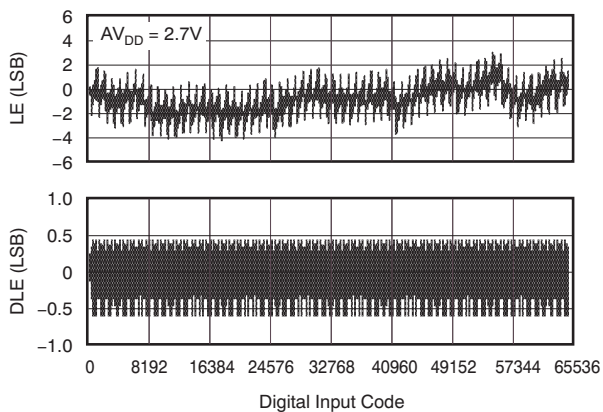

Figure 44. DAC8411 16-Bit Linearity Error and Differential Linearity Error vs Code ( $-40^\circ\text{C}$ )

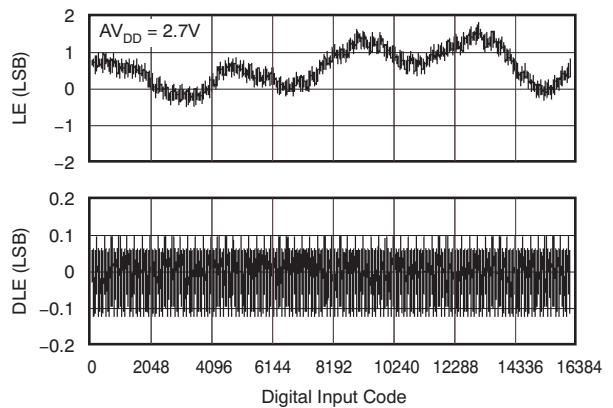

Figure 45. DAC8311 14-Bit Linearity Error and Differential Linearity Error vs Code ( $-40^\circ\text{C}$ )



Typical Characteristics:  $AV_{DD} = 2.7\text{ V}$  (continued)

at  $T_A = 25^\circ\text{C}$ , and  $AV_{DD} = 2.7\text{ V}$ , unless otherwise noted.

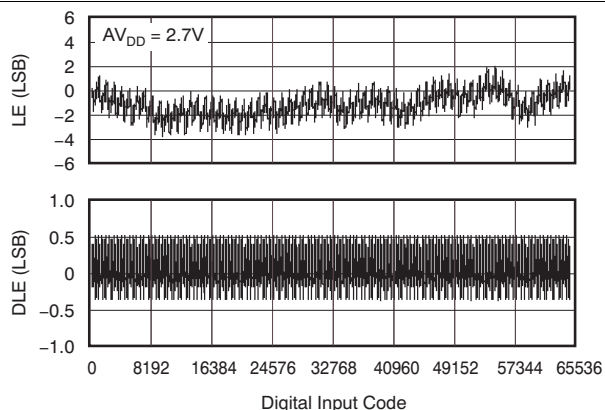

Figure 46. DAC8411 16-Bit Linearity Error and Differential Linearity Error vs Code ( $25^\circ\text{C}$ )

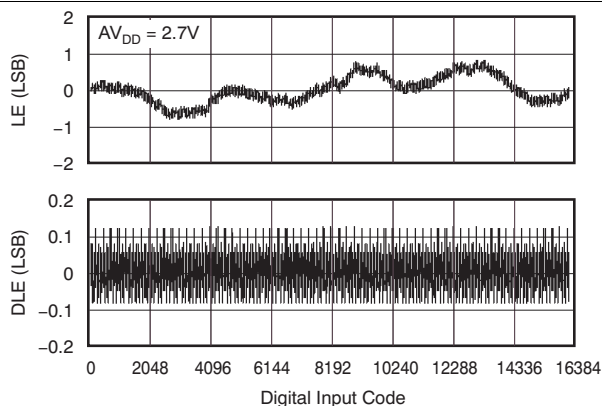

Figure 47. DAC8311 14-Bit Linearity Error and Differential Linearity Error vs Code ( $25^\circ\text{C}$ )

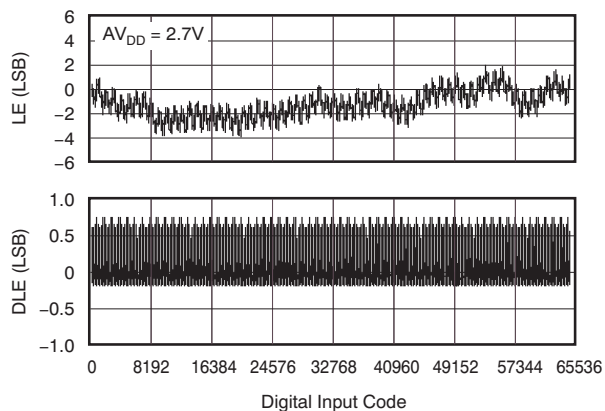

Figure 48. DAC8411 16-Bit Linearity Error and Differential Linearity Error vs Code ( $125^\circ\text{C}$ )

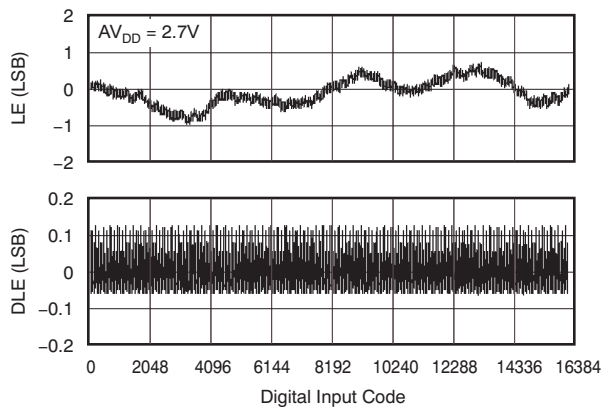

Figure 49. DAC8311 14-Bit Linearity Error and Differential Linearity Error vs Code ( $125^\circ\text{C}$ )

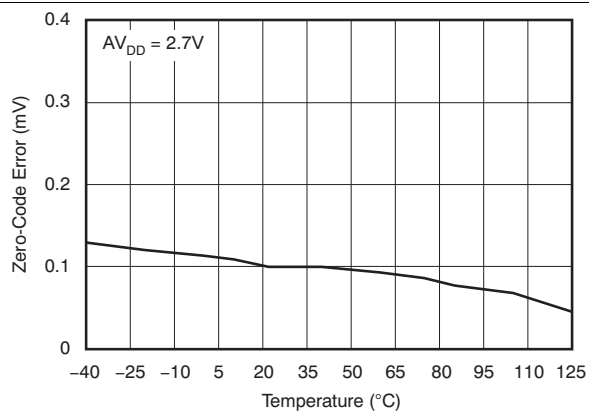

Figure 50. Zero-Code Error vs Temperature

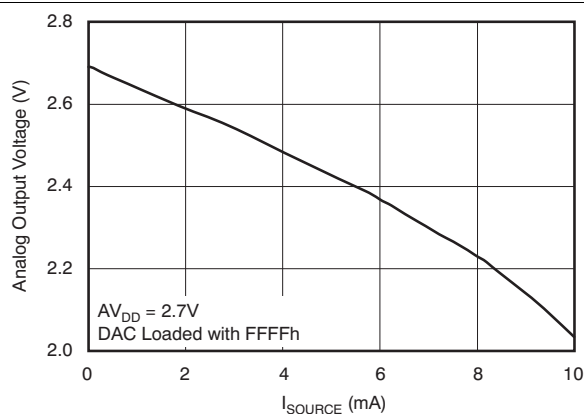
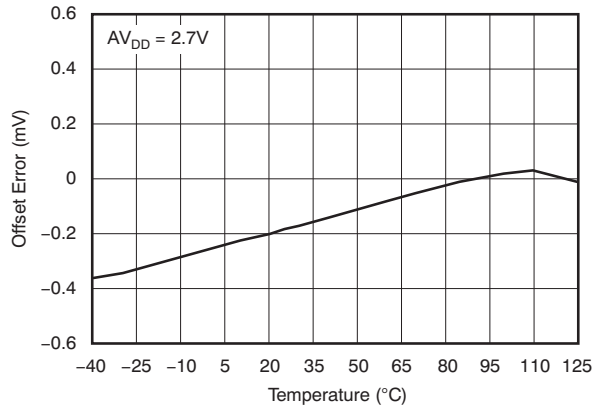

Figure 51. Source Current at Positive Rail

**Typical Characteristics: AV<sub>DD</sub> = 2.7 V (continued)**

at T<sub>A</sub> = 25°C, and AV<sub>DD</sub> = 2.7 V, unless otherwise noted.



**Figure 52. Offset Error vs Temperature**

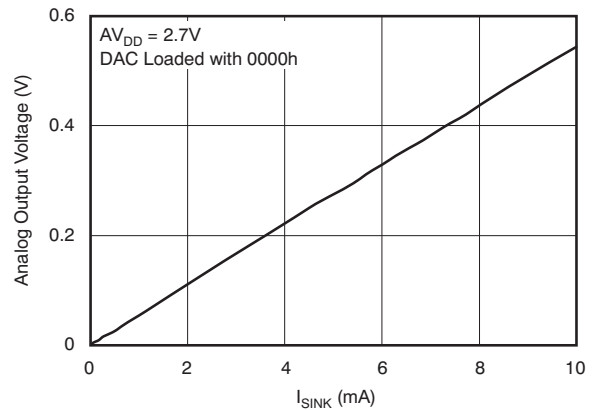

**Figure 53. Sink Current at Negative Rail**

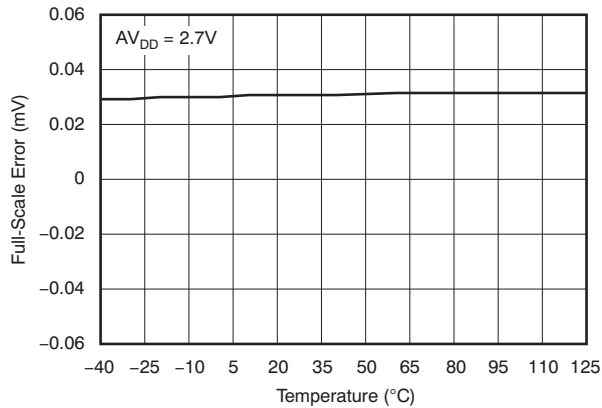

**Figure 54. Full-Scale Error vs Temperature**

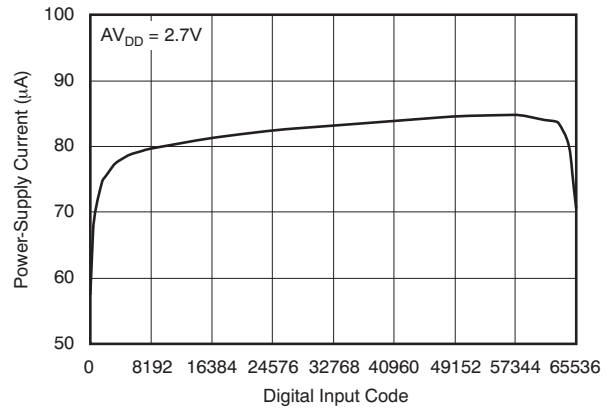

**Figure 55. Power-Supply Current vs Digital Input Code**

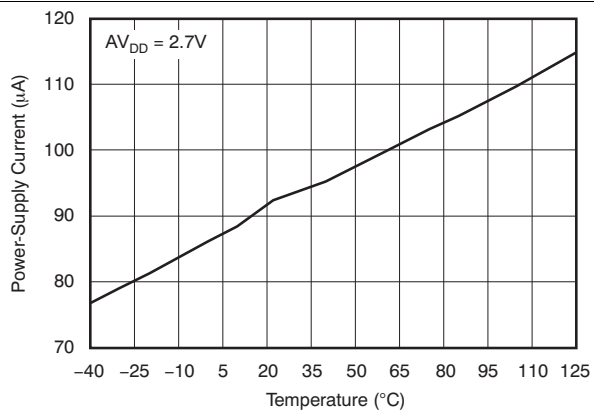

**Figure 56. Power-Supply Current vs Temperature**

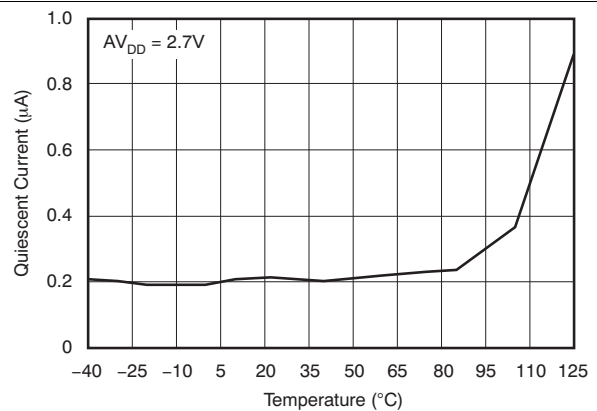

**Figure 57. Power-Down Current vs Temperature**

Typical Characteristics:  $AV_{DD} = 2.7\text{ V}$  (continued)

at  $T_A = 25^\circ\text{C}$ , and  $AV_{DD} = 2.7\text{ V}$ , unless otherwise noted.

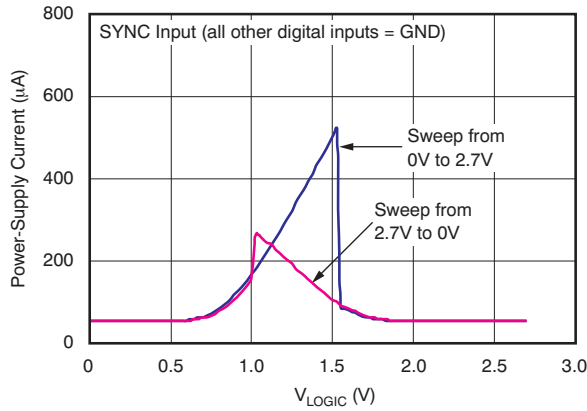

Figure 58. Power-Supply Current vs Logic Input Voltage

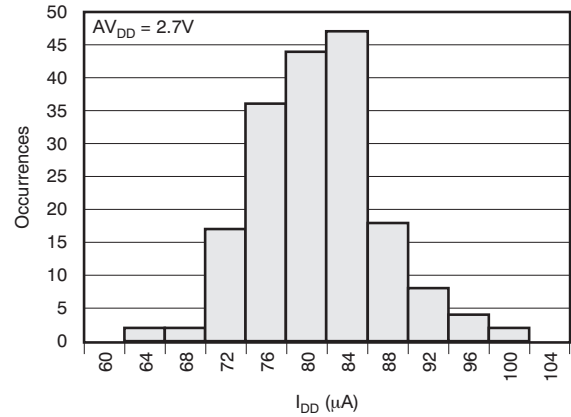

Figure 59. Power-Supply Current Histogram

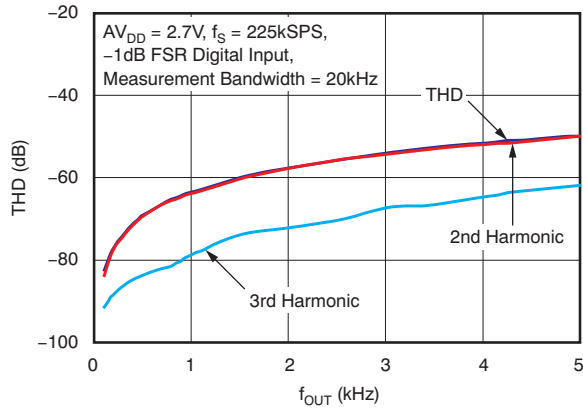

Figure 60. Total Harmonic Distortion vs Output Frequency

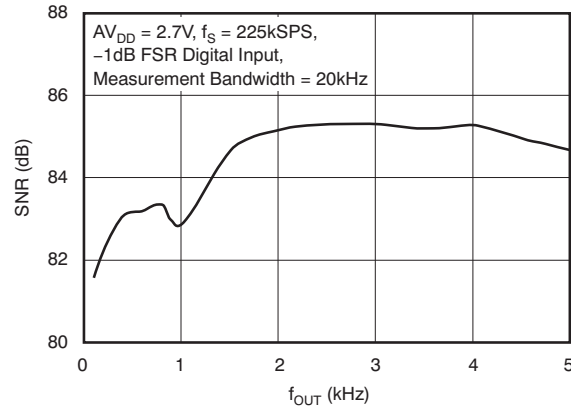

Figure 61. Signal-to-Noise Ratio vs Output Frequency

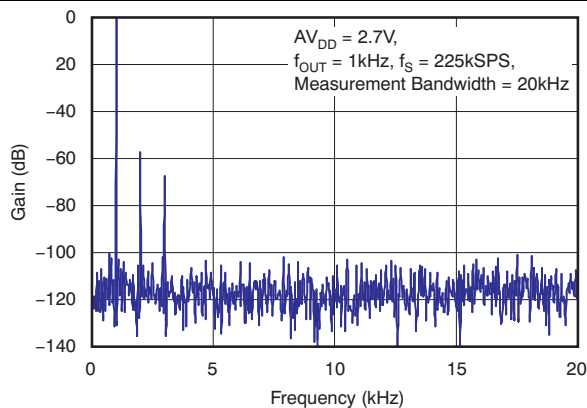

Figure 62. Power Spectral Density

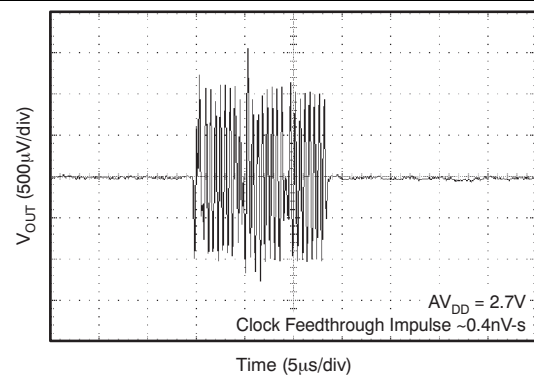
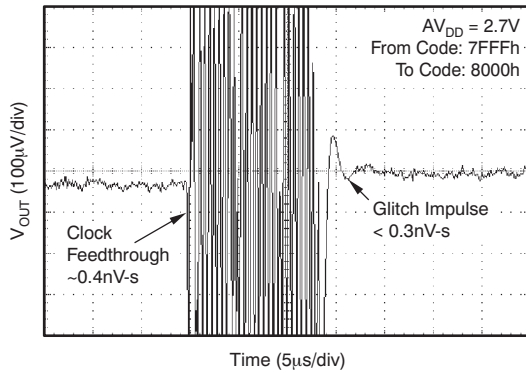

Figure 63. Clock Feedthrough 2.7 V, 20 mHz, Midscale

**Typical Characteristics:  $AV_{DD} = 2.7\text{ V}$  (continued)**

at  $T_A = 25^\circ\text{C}$ , and  $AV_{DD} = 2.7\text{ V}$ , unless otherwise noted.



**Figure 64. Glitch Energy 2.7 V, 16-Bit, 1LSB Step, Rising Edge**

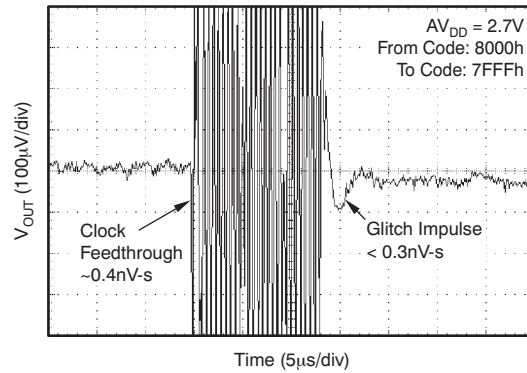

**Figure 65. Glitch Energy 2.7 V, 16-Bit, 1LSB Step, Falling Edge**

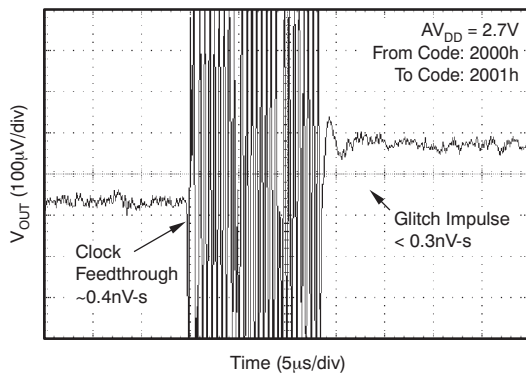

**Figure 66. Glitch Energy 2.7 V, 14-Bit, 1LSB Step, Rising Edge**

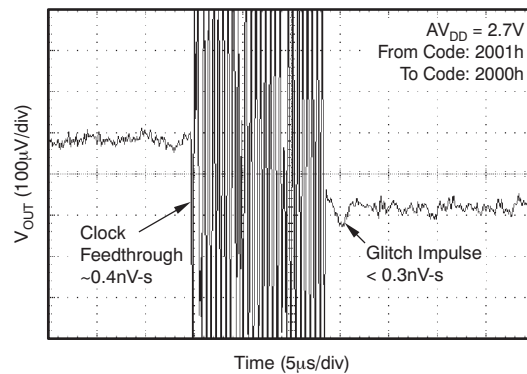

**Figure 67. Glitch Energy 2.7 V, 14-Bit, 1LSB Step, Falling Edge**

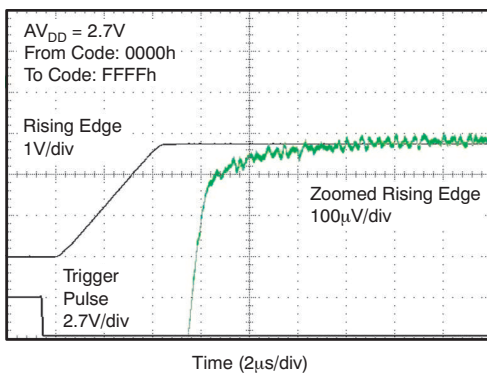

**Figure 68. Full-Scale Settling Time 2.7 V Rising Edge**

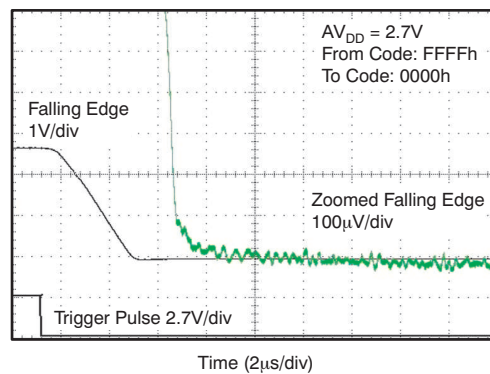

**Figure 69. Full-Scale Settling Time 2.7 V Falling Edge**

Typical Characteristics:  $AV_{DD} = 2.7\text{ V}$  (continued)

at  $T_A = 25^\circ\text{C}$ , and  $AV_{DD} = 2.7\text{ V}$ , unless otherwise noted.

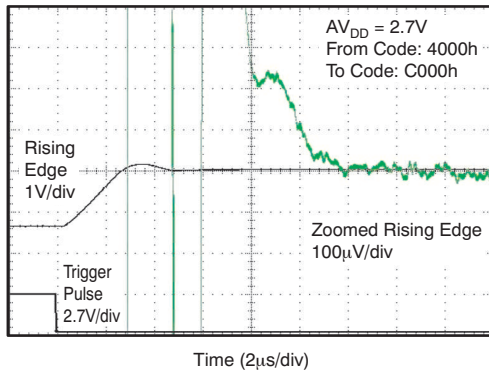

Figure 70. Half-Scale Settling Time 2.7 V Rising Edge

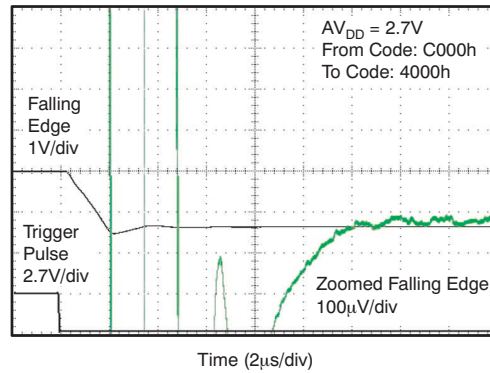

Figure 71. Half-Scale Settling Time 2.7 V Falling Edge

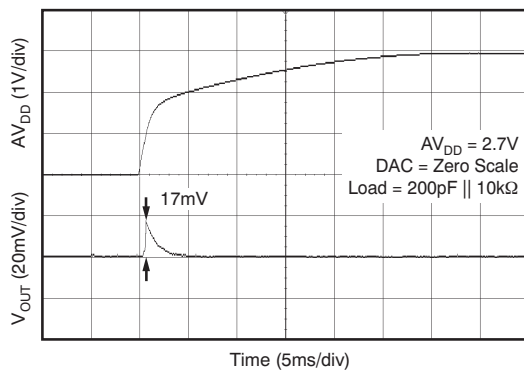

Figure 72. Power-On Reset to 0-V Power-On Glitch

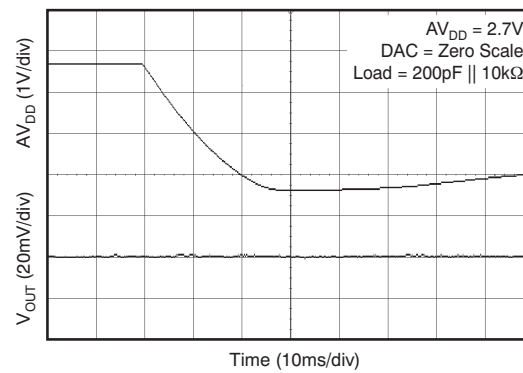

Figure 73. Power-Off Glitch

## 8 Detailed Description

### 8.1 Overview

The DAC8x11 family of devices are low-power, single-channel, voltage output DACs. These devices are monotonic by design, provide excellent linearity, and minimize undesired code-to-code transient voltages while offering an easy upgrade path within a pin-compatible family. All devices use a versatile, 3-wire serial interface that operates at clock rates of up to 50 MHz and is compatible with standard SPI, QSPI, Microwire, and digital signal processor (DSP) interfaces.

### 8.2 Functional Block Diagram

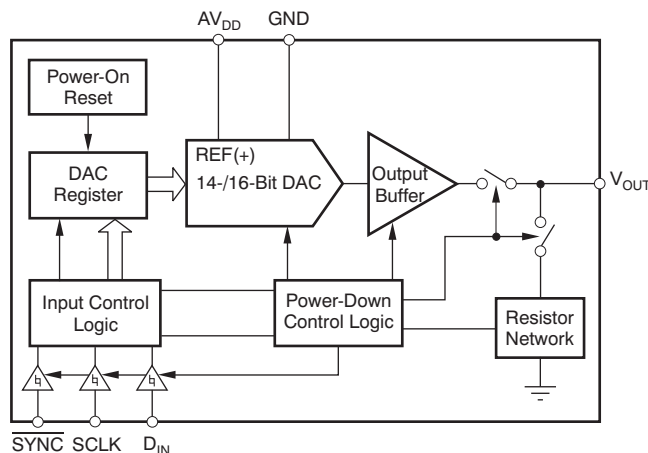

### 8.3 Feature Description

#### 8.3.1 DAC Section

The DAC8311 and DAC8411 are fabricated using Texas Instruments' proprietary HPA07 process technology. The architecture consists of a string DAC followed by an output buffer amplifier. Because there is no reference input pin, the power supply ( $AV_{DD}$ ) acts as the reference. Figure 74 shows a block diagram of the DAC architecture.

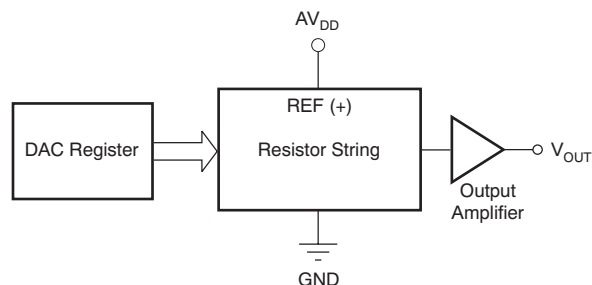

Figure 74. DAC8x11 Architecture

The input coding to the DAC8311 and DAC8411 is straight binary, so the ideal output voltage is given by:

$$V_{OUT} = AV_{DD} \times \frac{D}{2^n}$$

where

- $n$  = resolution in bits; either 14 (DAC8311) or 16 (DAC8411).
- $D$  = decimal equivalent of the binary code that is loaded to the DAC register; it ranges from 0 to 16,383 for the 14-bit DAC8311, or 0 to 65,535 for the 16-bit DAC8411.

## Feature Description (continued)

### 8.3.2 Resistor String

The resistor string section is shown in [Figure 75](#). It is simply a string of resistors, each of value R. The code loaded into the DAC register determines at which node on the string the voltage is tapped off to be fed into the output amplifier by closing one of the switches connecting the string to the amplifier. The resistor string architecture is inherently monotonic.

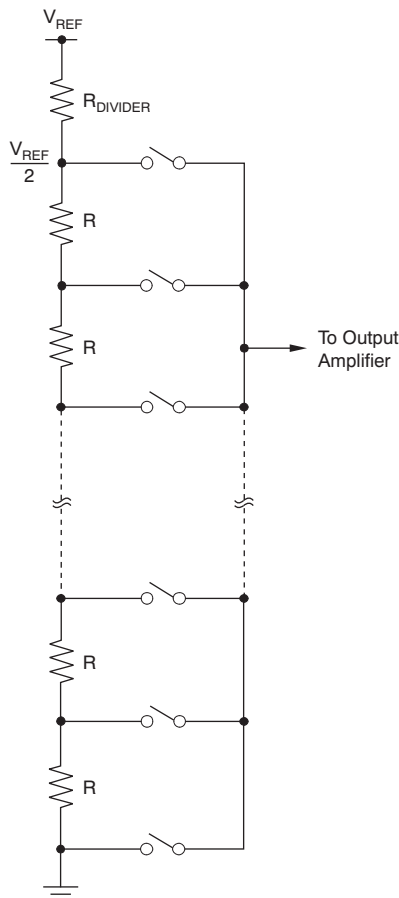

**Figure 75. Resistor String**

### 8.3.3 Output Amplifier

The output buffer amplifier is capable of generating rail-to-rail voltages on its output which gives an output range of 0V to  $AV_{DD}$ . The output amplifier is capable of driving a load of 2 k $\Omega$  in parallel with 1000 pF to GND. The source and sink capabilities of the output amplifier can be seen in the Typical Characteristics section for each device. The slew rate is 0.7 V/ $\mu$ s with a half-scale settling time of typically 6  $\mu$ s with the output unloaded.

### 8.3.4 Power-On Reset to Zero-Scale

The DAC8x11 contains a power-on reset circuit that controls the output voltage during power up. On power up, the DAC register is filled with zeros and the output voltage is 0 V. The DAC register remains that way until a valid write sequence is made to the DAC. This design is useful in applications where it is important to know the state of the output of the DAC while it is in the process of powering up.

The occurring power-on glitch impulse is only a few mV (typically, 17 mV; see [Figure 31](#), [Figure 72](#), or [Figure 31](#)).

## 8.4 Device Functional Modes

### 8.4.1 Power-Down Modes

The DAC8x11 contains four separate modes of operation. These modes are programmable by setting two bits (PD1 and PD0) in the control register. Table 3 shows how the state of the bits corresponds to the mode of operation of the device.

**Table 3. Modes of Operation for the DAC8x11**

PD1	PD0	OPERATING MODE
<b>NORMAL MODE</b>		
0	0	Normal Operation
<b>POWER-DOWN MODES</b>		
0	1	Output 1 k $\Omega$ to GND
1	0	Output 100 k $\Omega$ to GND
1	1	High-Z

When both bits are set to 0, the device works normally with a standard power consumption of typically 80  $\mu$ A at 2 V. However, for the three power-down modes, the typical supply current falls to 0.5  $\mu$ A at 5 V, 0.4  $\mu$ A at 3 V, and 0.1  $\mu$ A at 2.0 V. Not only does the supply current fall, but the output stage is also internally switched from the output of the amplifier to a resistor network of known values. The advantage of this architecture is that the output impedance of the part is known while the part is in power-down mode. There are three different options. The output is connected internally to GND either through a 1-k $\Omega$  resistor or a 100-k $\Omega$  resistor, or is left open-circuited (High-Z). See Figure 76 for the output stage.

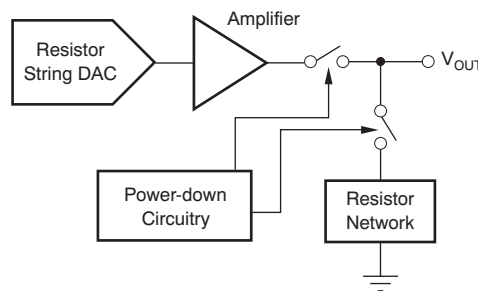

**Figure 76. Output Stage During Power-Down**

All linear circuitry is shut down when the power-down mode is activated. However, the contents of the DAC register are unaffected when in power-down. The time to exit power-down is typically 50  $\mu$ s for  $A_{V_{DD}} = 5$  V and  $A_{V_{DD}} = 3$  V. See the [Typical Characteristics:  \$A\_{V\_{DD}} = 5\$  V](#) for each device for more information.



## 8.5 Programming

### 8.5.1 DAC8311 Serial Interface

The DAC8311 has a 3-wire serial interface ( $\overline{\text{SYNC}}$ , SCLK, and DIN) compatible with SPI, QSPI, and Microwire interface standards, as well as most DSPs. See [Figure 1](#) for an example of a typical write sequence.

#### 8.5.1.1 DAC8311 Input Shift Register

The input shift register is 16 bits wide, as shown in [Figure 77](#). The first two bits (PD0 and PD1) are reserved control bits that set the desired mode of operation (normal mode or any one of three power-down modes) as indicated in [Table 3](#).

The write sequence begins by bringing the  $\overline{\text{SYNC}}$  line low. Data from the DIN line are clocked into the 16-bit shift register on each falling edge of SCLK. The serial clock frequency can be as high as 50 MHz, making the DAC8311 compatible with high-speed DSPs. On the 16th falling edge of the serial clock, the last data bit is clocked in and the programmed function is executed.

At this point, the  $\overline{\text{SYNC}}$  line may be kept low or brought high. In either case, it must be brought high for a minimum of 20 ns before the next write sequence so that a falling edge of  $\overline{\text{SYNC}}$  can initiate the next write sequence.

#### 8.5.1.2 DAC8311 $\overline{\text{SYNC}}$ Interrupt

In a normal write sequence, the  $\overline{\text{SYNC}}$  line is kept low for at least 16 falling edges of SCLK and the DAC is updated on the 16th falling edge. However, bringing  $\overline{\text{SYNC}}$  high before the 16th falling edge acts as an interrupt to the write sequence. The shift register is reset and the write sequence is seen as invalid. Neither an update of the DAC register contents or a change in the operating mode occurs, as shown in [Figure 78](#).

Figure 77. DAC8311 Data Input Register

DB15 DB14														DB0	
PD1	PD0	D13	D12	D11	D10	D9	D8	D7	D6	D5	D4	D3	D2	D1	D0

LEGEND: R/W = Read/Write; R = Read only; -n = value after reset

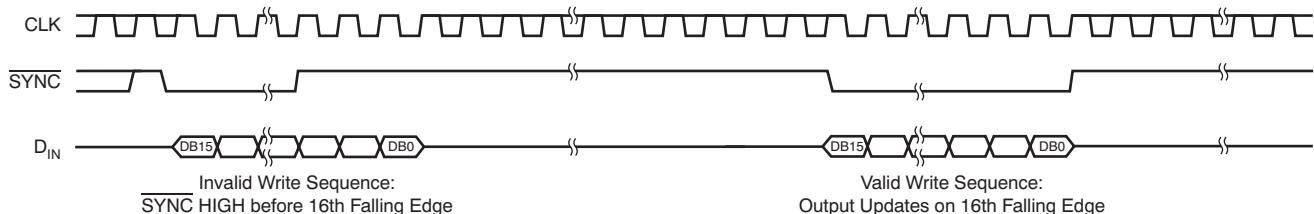

Figure 78. DAC8311  $\overline{\text{SYNC}}$  Interrupt Facility

### 8.5.2 DAC8411 Serial Interface

The DAC8411 has a 3-wire serial interface ( $\overline{\text{SYNC}}$ , SCLK, and DIN) compatible with SPI, QSPI, and Microwire interface standards, as well as most DSPs. See the [Figure 1](#) for an example of a typical write sequence.

#### 8.5.2.1 DAC8411 Input Shift Register

The input shift register is 24 bits wide, as shown in [Figure 79](#). The first two bits are reserved control bits (PD0 and PD1) that set the desired mode of operation (normal mode or any one of three power-down modes) as indicated in [Table 3](#). The last six bits are *don't care*.

The write sequence begins by bringing the  $\overline{\text{SYNC}}$  line low. Data from the DIN line are clocked into the 24-bit shift register on each falling edge of SCLK. The serial clock frequency can be as high as 50 MHz, making the DAC8411 compatible with high-speed DSPs. On the 18th falling edge of the serial clock, the last data bit is clocked in and the programmed function is executed. The last six bits are *don't care*.

At this point, the  $\overline{\text{SYNC}}$  line may be kept low or brought high. In either case, it must be brought high for a minimum of 20 ns before the next write sequence so that a falling edge of  $\overline{\text{SYNC}}$  can initiate the next write sequence. As previously mentioned, it must be brought high again before the next write sequence.

The  $\overline{\text{SYNC}}$  line may be brought high after the 18th bit is clocked in because the last six bits are *don't care*.

### 8.5.2.2 DAC8411 $\overline{\text{SYNC}}$ Interrupt

In a normal write sequence, the  $\overline{\text{SYNC}}$  line is kept low for 24 falling edges of  $\text{SCLK}$  and the DAC is updated on the 18th falling edge, ignoring the last six *don't care* bits. However, bringing  $\overline{\text{SYNC}}$  high before the 18th falling edge acts as an interrupt to the write sequence. The shift register is reset and the write sequence is seen as invalid. Neither an update of the DAC register contents or a change in the operating mode occurs, as shown in Figure 80.

**Figure 79. DAC8411 Data Input Register**

DB23							
PD1	PD0	D15	D14	D13	D12	D11	D10
D9	D8	D7	D6	D5	D4	D3	D2
DB7		DB6		DB5			
D1	D0	X	X	X	X	X	X

LEGEND: R/W = Read/Write; R = Read only; -n = value after reset

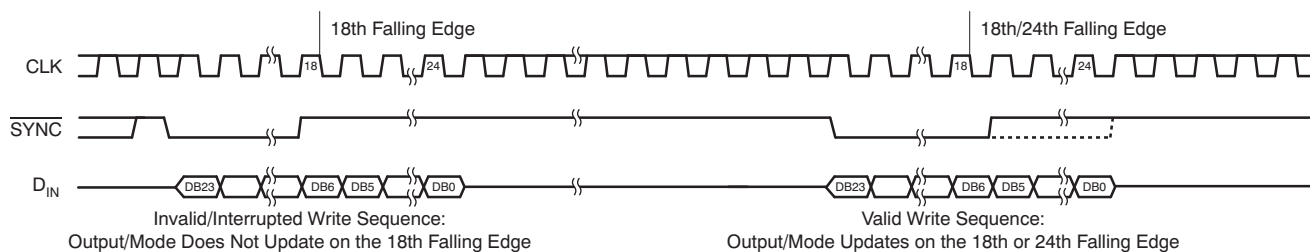

**Figure 80. DAC8411  $\overline{\text{SYNC}}$  Interrupt Facility**

## 9 Application and Implementation

### NOTE

Information in the following applications sections is not part of the TI component specification, and TI does not warrant its accuracy or completeness. TI's customers are responsible for determining suitability of components for their purposes. Customers should validate and test their design implementation to confirm system functionality.

### 9.1 Application Information

#### 9.1.1 Microprocessor Interfacing

##### 9.1.1.1 DAC8x11 to 8051 Interface

Figure 81 shows a serial interface between the DAC8x11 and a typical 8051-type microcontroller. The setup for the interface is as follows: TXD of the 8051 drives SCLK of the DAC8x11, while RXD drives the serial data line of the part. The SYNC signal is derived from a bit programmable pin on the port. In this case, port line P3.3 is used. When data are to be transmitted to the DAC8x11, P3.3 is taken low. The 8051 transmits data only in 8-bit bytes; thus, only eight falling clock edges occur in the transmit cycle. To load data to the DAC, P3.3 remains low after the first eight bits are transmitted, and a second write cycle is initiated to transmit the second byte of data. P3.3 is taken high following the completion of this cycle. The 8051 outputs the serial data in a format which has the LSB first. The DAC8x11 requires its data with the MSB as the first bit received. Therefore, the 8051 transmit routine must take this requirement into account, and *mirror* the data as needed.

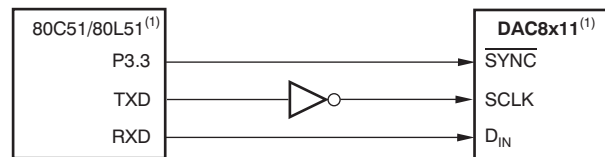

NOTE: (1) Additional pins omitted for clarity.

Figure 81. DAC8x11 to 80C51/80L51 Interfaces

##### 9.1.1.2 DAC8x11 to Microwire Interface

Figure 82 shows an interface between the DAC8x11 and any Microwire-compatible device. Serial data are shifted out on the falling edge of the serial clock and are clocked into the DAC8x11 on the rising edge of the SK signal.

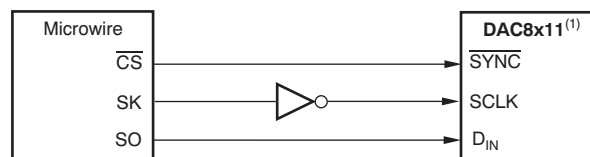

NOTE: (1) Additional pins omitted for clarity.

Figure 82. DAC8x11 to Microwire Interface

## Application Information (continued)

### 9.1.1.3 DAC8x11 to 68HC11 Interface

Figure 83 shows a serial interface between the DAC8x11 and the 68HC11 microcontroller. SCK of the 68HC11 drives the SCLK of the DAC8x11, while the MOSI output drives the serial data line of the DAC. The SYNC signal is derived from a port line (PC7), similar to what was done for the 8051.

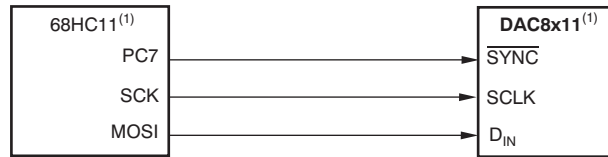

NOTE: (1) Additional pins omitted for clarity.

**Figure 83. DAC8X11 to 68HC11 Interface**

The 68HC11 should be configured so that its CPOL bit is a '0' and its CPHA bit is a '1'. This configuration causes data appearing on the MOSI output to be valid on the falling edge of SCK. When data are being transmitted to the DAC, the SYNC line is taken low (PC7). Serial data from the 68HC11 are transmitted in 8-bit bytes with only eight falling clock edges occurring in the transmit cycle. Data are transmitted MSB first. In order to load data to the DAC8x11, PC7 is held low after the first eight bits are transferred, and a second serial write operation is performed to the DAC; PC7 is taken high at the end of this procedure.

## 9.2 Typical Applications

### 9.2.1 Loop Powered Transmitter

The described loop powered transmitter can accurately source currents from 4 mA to 20 mA.

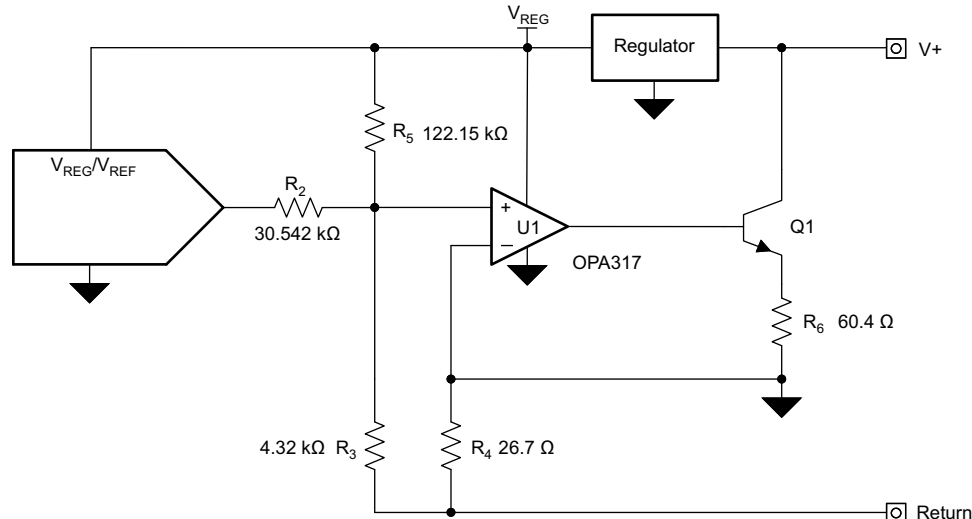

**Figure 84. Loop Powered Transmitter Schematic**

#### 9.2.1.1 Design Requirements

The transmitter has only two external input terminals; a supply connection and a ground (or return) connection. The transmitter communicates back to the host, typically a PLC analog input module, by precisely controlling the magnitude of the return current. In order to conform to the 4-mA to 20-mA communication standards, the complete transmitter must consume less than 4 mA of current.

## Typical Applications (continued)

The complete design of this circuit is outlined in [TIPD158, Low Cost Loop-Powered 4-20mA Transmitter EMC/EMI Tested Reference Design](#). The design is expected to be low-cost and deliver immunity to the IEC61000-4 suite of tests with minimum impact on the accuracy of the system. Reference design [TIPD158](#) includes the design goals, simulated results, and measured performance.

### 9.2.1.2 Detailed Design Procedure

Amplifier U1 uses negative feedback to make sure that the potentials at the inverting ( $V_-$ ) and noninverting ( $V_+$ ) input terminals are equal. In this configuration,  $V_-$  is directly tied to the local GND; therefore, the potential at the noninverting input terminal is driven to local ground. Thus, the voltage difference across  $R_2$  is the DAC output voltage ( $V_{OUT}$ ), and the voltage difference across  $R_5$  is the regulator voltage ( $V_{REG}$ ). These voltage differences cause currents to flow through  $R_2$  and  $R_5$ , as illustrated in [Figure 85](#).

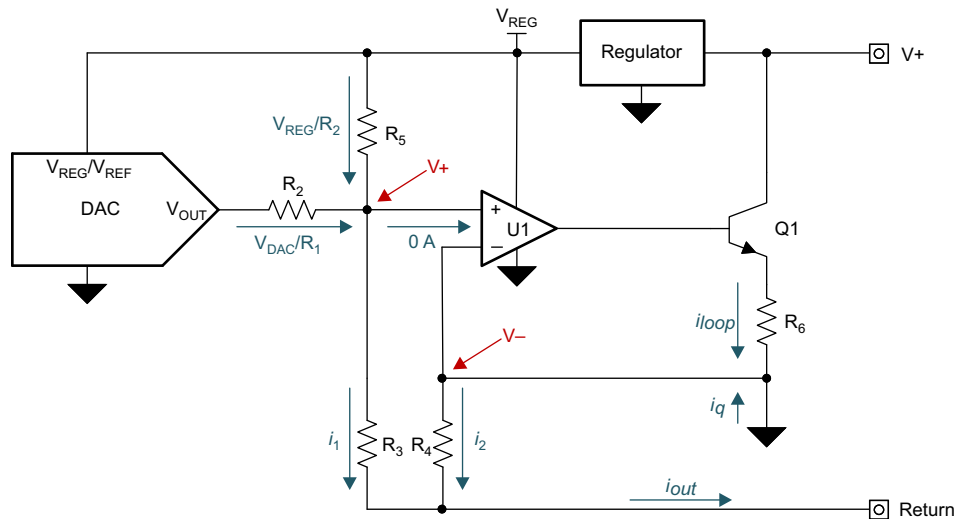

Figure 85. Voltage to Current Conversion

The currents from  $R_2$  and  $R_5$  sum into  $i_1$  (defined in [Equation 1](#)), and  $i_1$  flows through  $R_3$ .

$$i_1 = \frac{V_{DAC}}{R_2} + \frac{V_{REG}}{R_5} \quad (1)$$

Amplifier U2 drives the base of Q1, the NPN bipolar junction transistor (BJT), to allow current to flow through  $R_4$  so that the voltage drops across  $R_3$  and  $R_4$  remain equal. This design keeps the inverting and noninverting terminals at the same potential. A small part of the current through  $R_4$  is sourced by the quiescent current of all of the components used in the transmitter design (regulator, amplifier, and DAC). The voltage drops across  $R_3$  and  $R_4$  are equal; therefore, different-sized resistors cause different current flow through each resistor. Use these different-sized resistors to apply gain to the current flow through  $R_4$  by controlling the ratio of resistor  $R_3$  to  $R_4$ , as shown in [Equation 2](#):

$$\begin{aligned} V_+ &= i_1 \cdot R_3 \\ V_- &= i_2 \cdot R_4 \Rightarrow i_2 = \frac{i_1 \cdot R_3}{R_4} \\ V_+ &= V_- \end{aligned} \quad (2)$$

The current gain in the circuit helps allow a majority of the output current to come directly from the loop through Q1 instead of from the voltage-to-current converter. This current gain, in addition to the low-power components, keeps the current consumption of the voltage-to-current converter low. Currents  $i_1$  and  $i_2$  sum to form output current  $i_{out}$ , as shown in [Equation 3](#):

$$i_{out} = i_1 + i_2 = \frac{V_{DAC}}{R_2} + \frac{V_{REG}}{R_5} + \frac{R_3}{R_4} \cdot \left( \frac{V_{DAC}}{R_2} + \frac{V_{REG}}{R_5} \right) = \left( \frac{V_{DAC}}{R_2} + \frac{V_{REG}}{R_5} \right) \cdot \left( 1 + \frac{R_3}{R_4} \right) \quad (3)$$

### Typical Applications (continued)

The complete transfer function, arranged as a function of input code, is shown in Equation 4. The remaining sections divide this circuit into blocks for simplified discussion.

$$i_{out}(\text{Code}) = \left( \frac{V_{REG} \cdot \text{Code}}{2^{\text{Resolution}} \cdot R_2} + \frac{V_{REG}}{R_5} \right) \cdot \left( 1 + \frac{R_3}{R_4} \right) \tag{4}$$

Resistor  $R_6$  is included to reduce the gain of transistor Q1, and therefore, reduce the closed-loop gain of the voltage-to-current converter for a stable design. Size resistors  $R_2$ ,  $R_3$ ,  $R_4$ , and  $R_5$  based on the full-scale range of the DAC, regulator voltage, and the desired current output range of the design.

#### 9.2.1.3 Application Curves

Figure 86 shows the measured transfer function of the circuit. Figure 87 shows the total unadjusted error (TUE) of the circuit, staying below 0.15 %FSR.

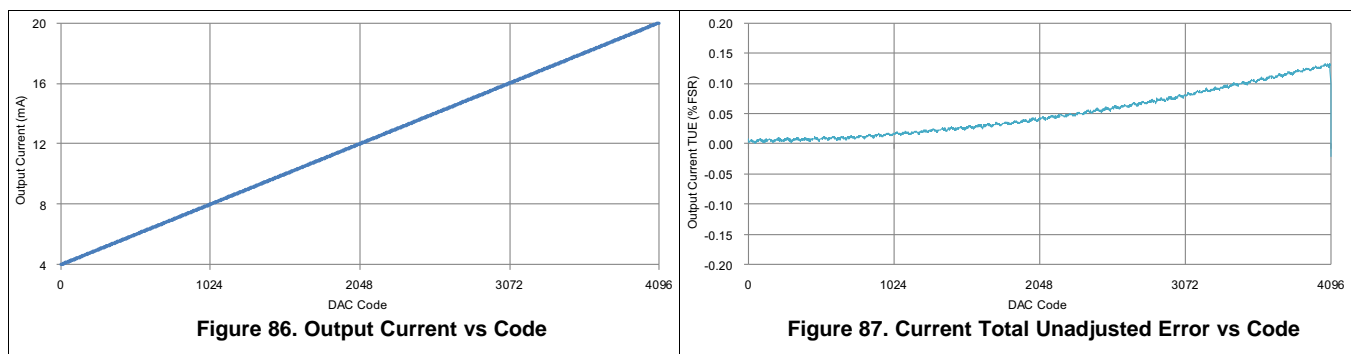

#### 9.2.2 Using the REF5050 as a Power Supply for the DAC8x11

As a result of the extremely low supply current required by the DAC8x11, an alternative option is to use a REF5050 5 V precision voltage reference to supply the required voltage to the part, as shown in Figure 88. This option is especially useful if the power supply is too noisy or if the system supply voltages are at some value other than 5 V. The REF5050 outputs a steady supply voltage for the DAC8x11. If the REF5050 is used, the current needed to supply DAC8x11 is typically 110  $\mu$ A at 5V, with no load on the output of the DAC. When the DAC output is loaded, the REF5050 also needs to supply the current to the load. The total current required (with a 5-k $\Omega$  load on the DAC output) is:

$$110 \mu\text{A} + (5 \text{ V} / 5 \text{ k}\Omega) = 1.11 \text{ mA}$$

The load regulation of the REF5050 is typically 0.002%/mA, resulting in an error of 90  $\mu$ V for the 1.1 -mA current drawn from it. This value corresponds to a 1.1 LSB error at 16bit (DAC8411).

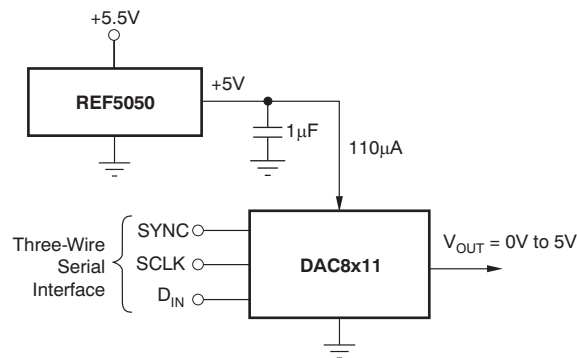

Figure 88. REF5050 as Power Supply to DAC8x11

## Typical Applications (continued)

For other power-supply voltages, alternative references such as the [REF3030](#) (3 V), [REF3033](#) (3.3 V), or [REF3220](#) (2.048 V) are recommended. For a full list of available voltage references from TI, see TI web site at [www.ti.com](http://www.ti.com).

### 9.2.3 Bipolar Operation Using the DAC8x11

The DAC8x11 has been designed for single-supply operation but a bipolar output range is also possible using the circuit in [Figure 89](#). The circuit shown gives an output voltage range of  $\pm 5V$ . Rail-to-rail operation at the amplifier output is achievable using an [OPA211](#), [OPA340](#), or [OPA703](#) as the output amplifier. For a full list of available operational amplifiers from TI, see TI web site at [www.ti.com](http://www.ti.com)

The output voltage for any input code can be calculated as follows:

$$V_O = \left[ AV_{DD} \times \left( \frac{D}{2^n} \right) \times \left( \frac{R_1 + R_2}{R_1} \right) - AV_{DD} \times \left( \frac{R_2}{R_1} \right) \right]$$

where

- n = resolution in bits; either 14 (DAC8311) or 16 (DAC8411).
- D = the input code in decimal; either 0 to 16,383 (DAC8311) or 0 to 65,535 (DAC8411).

With  $AV_{DD} = 5\text{ V}$ ,  $R_1 = R_2 = 10\text{ k}\Omega$ :

$$V_O = \left( \frac{10 \times D}{2^n} \right) - 5V \tag{6}$$

The resulting output voltage range is  $\pm 5V$ . Code 000h corresponds to a  $-5\text{-V}$  output and FFFFh (16-bit level) corresponding to a  $5\text{-V}$  output.

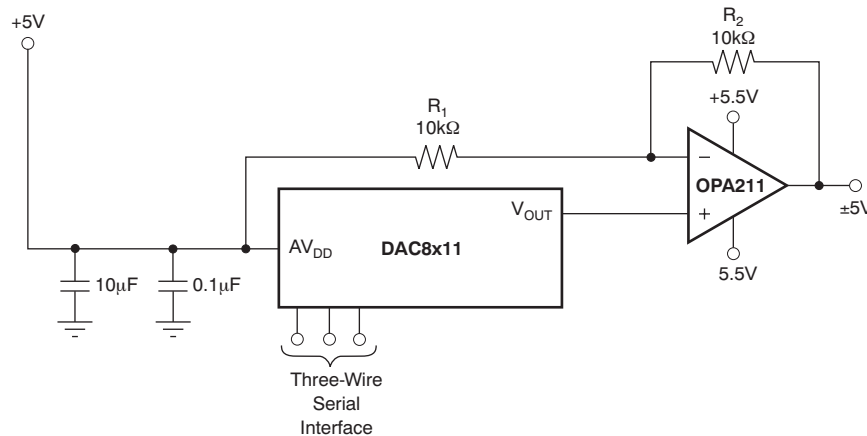

**Figure 89. Bipolar Operation With the DAC8x11**

## 10 Power Supply Recommendations

The DAC8x11 is designed to operate with a unipolar analog power supply ranging from 2 V to 5.5 V on the  $AV_{DD}$  pin. The  $AV_{DD}$  pin supplies power to the digital and analog circuits (including the resistor string) inside the DAC. The current consumption of this pin is specified in the [Electrical Characteristics](#) table. Use a 1- $\mu\text{F}$  to 10- $\mu\text{F}$  capacitor in parallel with a 0.1- $\mu\text{F}$  bypass capacitor on this pin to remove high-frequency noise.

## 11 Layout

### 11.1 Layout Guidelines

A precision analog component requires careful layout, adequate bypassing, and clean, well-regulated power supplies.

The DAC8x11 offers single-supply operation; it will often be used in close proximity with digital logic, microcontrollers, microprocessors, and digital signal processors. The more digital logic present in the design and the higher the switching speed, the more difficult it will be to achieve good performance from the converter.

Because of the single ground pin of the DAC8x11, all return currents, including digital and analog return currents, must flow through the GND pin. Ideally, GND would be connected directly to an analog ground plane. This plane would be separate from the ground connection for the digital components until they were connected at the power entry point of the system.

The power applied to  $AV_{DD}$  should be well-regulated and low-noise. Switching power supplies and dc/dc converters often have high-frequency glitches or spikes riding on the output voltage. In addition, digital components can create similar high-frequency spikes as the internal logic switches state. This noise can easily couple into the DAC output voltage through various paths between the power connections and analog output. This condition is particularly true for the DAC8x11, as the power supply is also the reference voltage for the DAC.

As with the GND connection,  $AV_{DD}$  should be connected to a 5 V power supply plane or trace that is separate from the connection for digital logic until they are connected at the power entry point. In addition, TI strongly recommends the 1  $\mu$ F to 1  $\mu$ F and 0.1  $\mu$ F bypass capacitors. In some situations, additional bypassing may be required, such as a 100  $\mu$ F electrolytic capacitor or even a *Pi* filter made up of inductors and capacitors—all designed to essentially low-pass filter the 5 V supply, removing the high-frequency noise.

### 11.2 Layout Example

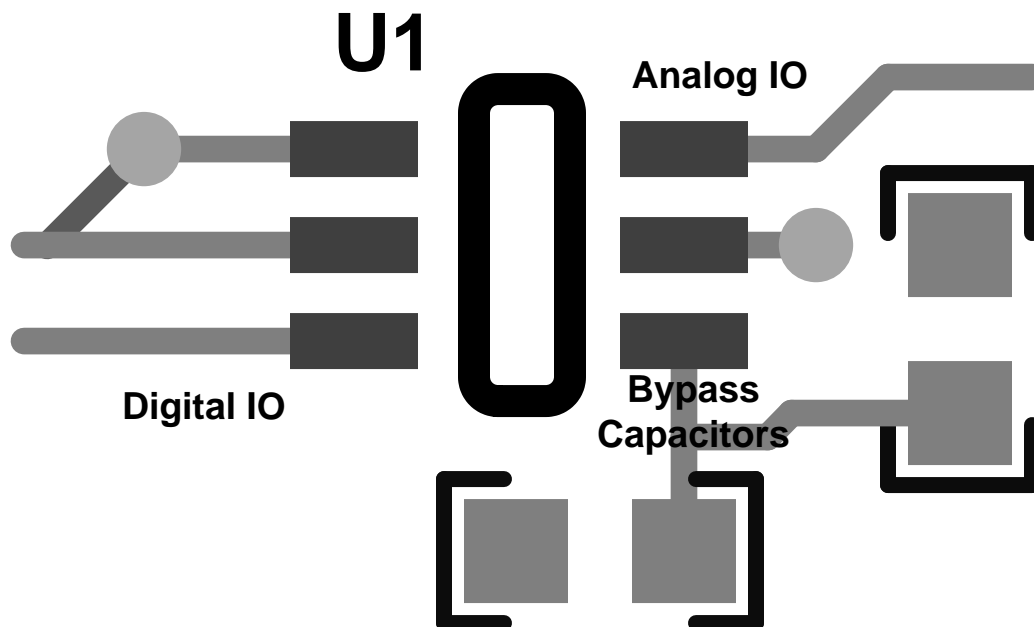

Figure 90. Recommended Layout



## 12 Device and Documentation Support

### 12.1 Related Links

The table below lists quick access links. Categories include technical documents, support and community resources, tools and software, and quick access to sample or buy.

**Table 4. Related Links**

PARTS	PRODUCT FOLDER	SAMPLE & BUY	TECHNICAL DOCUMENTS	TOOLS & SOFTWARE	SUPPORT & COMMUNITY
DAC8311	<a href="#">Click here</a>	<a href="#">Click here</a>	<a href="#">Click here</a>	<a href="#">Click here</a>	<a href="#">Click here</a>
DAC8411	<a href="#">Click here</a>	<a href="#">Click here</a>	<a href="#">Click here</a>	<a href="#">Click here</a>	<a href="#">Click here</a>

### 12.2 Community Resources

The following links connect to TI community resources. Linked contents are provided "AS IS" by the respective contributors. They do not constitute TI specifications and do not necessarily reflect TI's views; see TI's [Terms of Use](#).

**TI E2E™ Online Community** *TI's Engineer-to-Engineer (E2E) Community*. Created to foster collaboration among engineers. At [e2e.ti.com](http://e2e.ti.com), you can ask questions, share knowledge, explore ideas and help solve problems with fellow engineers.

**Design Support** *TI's Design Support* Quickly find helpful E2E forums along with design support tools and contact information for technical support.

### 12.3 Trademarks

E2E is a trademark of Texas Instruments.  
 SPI, QSPI are trademarks of Motorola, Inc.  
 All other trademarks are the property of their respective owners.

### 12.4 Electrostatic Discharge Caution



These devices have limited built-in ESD protection. The leads should be shorted together or the device placed in conductive foam during storage or handling to prevent electrostatic damage to the MOS gates.

### 12.5 Glossary

**SLYZ022** — *TI Glossary*.

This glossary lists and explains terms, acronyms, and definitions.

## 13 Mechanical, Packaging, and Orderable Information

The following pages include mechanical, packaging, and orderable information. This information is the most current data available for the designated devices. This data is subject to change without notice and revision of this document. For browser-based versions of this data sheet, refer to the left-hand navigation.

**PACKAGING INFORMATION**

Orderable Device	Status (1)	Package Type	Package Drawing	Pins	Package Qty	Eco Plan (2)	Lead/Ball Finish (6)	MSL Peak Temp (3)	Op Temp (°C)	Device Marking (4/5)	Samples
DAC8311IDCKR	ACTIVE	SC70	DCK	6	3000	Green (RoHS & no Sb/Br)	CU NIPDAU	Level-1-260C-UNLIM	-40 to 125	D83	<a href="#">Samples</a>
DAC8311IDCKRG4	ACTIVE	SC70	DCK	6	3000	Green (RoHS & no Sb/Br)	CU NIPDAU	Level-1-260C-UNLIM	-40 to 125	D83	<a href="#">Samples</a>
DAC8311IDCKT	ACTIVE	SC70	DCK	6	250	Green (RoHS & no Sb/Br)	CU NIPDAU	Level-1-260C-UNLIM	-40 to 125	D83	<a href="#">Samples</a>
DAC8411IDCKR	ACTIVE	SC70	DCK	6	3000	Green (RoHS & no Sb/Br)	CU NIPDAU	Level-1-260C-UNLIM	-40 to 125	D84	<a href="#">Samples</a>
DAC8411IDCKRG4	ACTIVE	SC70	DCK	6	3000	Green (RoHS & no Sb/Br)	CU NIPDAU	Level-1-260C-UNLIM	-40 to 125	D84	<a href="#">Samples</a>
DAC8411IDCKT	ACTIVE	SC70	DCK	6	250	Green (RoHS & no Sb/Br)	CU NIPDAU	Level-1-260C-UNLIM	-40 to 125	D84	<a href="#">Samples</a>
DAC8411IDCKTG4	ACTIVE	SC70	DCK	6	250	Green (RoHS & no Sb/Br)	CU NIPDAU	Level-1-260C-UNLIM	-40 to 125	D84	<a href="#">Samples</a>

(1) The marketing status values are defined as follows:

**ACTIVE:** Product device recommended for new designs.

**LIFEBUY:** TI has announced that the device will be discontinued, and a lifetime-buy period is in effect.

**NRND:** Not recommended for new designs. Device is in production to support existing customers, but TI does not recommend using this part in a new design.

**PREVIEW:** Device has been announced but is not in production. Samples may or may not be available.

**OBSELETE:** TI has discontinued the production of the device.

(2) Eco Plan - The planned eco-friendly classification: Pb-Free (RoHS), Pb-Free (RoHS Exempt), or Green (RoHS & no Sb/Br) - please check <http://www.ti.com/productcontent> for the latest availability information and additional product content details.

**TBD:** The Pb-Free/Green conversion plan has not been defined.

**Pb-Free (RoHS):** TI's terms "Lead-Free" or "Pb-Free" mean semiconductor products that are compatible with the current RoHS requirements for all 6 substances, including the requirement that lead not exceed 0.1% by weight in homogeneous materials. Where designed to be soldered at high temperatures, TI Pb-Free products are suitable for use in specified lead-free processes.

**Pb-Free (RoHS Exempt):** This component has a RoHS exemption for either 1) lead-based flip-chip solder bumps used between the die and package, or 2) lead-based die adhesive used between the die and leadframe. The component is otherwise considered Pb-Free (RoHS compatible) as defined above.

**Green (RoHS & no Sb/Br):** TI defines "Green" to mean Pb-Free (RoHS compatible), and free of Bromine (Br) and Antimony (Sb) based flame retardants (Br or Sb do not exceed 0.1% by weight in homogeneous material)

(3) MSL, Peak Temp. - The Moisture Sensitivity Level rating according to the JEDEC industry standard classifications, and peak solder temperature.

(4) There may be additional marking, which relates to the logo, the lot trace code information, or the environmental category on the device.

<sup>(5)</sup> Multiple Device Markings will be inside parentheses. Only one Device Marking contained in parentheses and separated by a "-" will appear on a device. If a line is indented then it is a continuation of the previous line and the two combined represent the entire Device Marking for that device.

<sup>(6)</sup> Lead/Ball Finish - Orderable Devices may have multiple material finish options. Finish options are separated by a vertical ruled line. Lead/Ball Finish values may wrap to two lines if the finish value exceeds the maximum column width.

**Important Information and Disclaimer:**The information provided on this page represents TI's knowledge and belief as of the date that it is provided. TI bases its knowledge and belief on information provided by third parties, and makes no representation or warranty as to the accuracy of such information. Efforts are underway to better integrate information from third parties. TI has taken and continues to take reasonable steps to provide representative and accurate information but may not have conducted destructive testing or chemical analysis on incoming materials and chemicals. TI and TI suppliers consider certain information to be proprietary, and thus CAS numbers and other limited information may not be available for release.

In no event shall TI's liability arising out of such information exceed the total purchase price of the TI part(s) at issue in this document sold by TI to Customer on an annual basis.

**TAPE AND REEL INFORMATION**

**QUADRANT ASSIGNMENTS FOR PIN 1 ORIENTATION IN TAPE**

\*All dimensions are nominal

Device	Package Type	Package Drawing	Pins	SPQ	Reel Diameter (mm)	Reel Width W1 (mm)	A0 (mm)	B0 (mm)	K0 (mm)	P1 (mm)	W (mm)	Pin1 Quadrant
DAC8311IDCKR	SC70	DCK	6	3000	177.8	9.7	2.3	2.52	1.2	4.0	8.0	Q3
DAC8311IDCKT	SC70	DCK	6	250	177.8	9.7	2.3	2.52	1.2	4.0	8.0	Q3
DAC8411IDCKR	SC70	DCK	6	3000	177.8	9.7	2.3	2.52	1.2	4.0	8.0	Q3
DAC8411IDCKT	SC70	DCK	6	250	177.8	9.7	2.3	2.52	1.2	4.0	8.0	Q3

**TAPE AND REEL BOX DIMENSIONS**

\*All dimensions are nominal

Device	Package Type	Package Drawing	Pins	SPQ	Length (mm)	Width (mm)	Height (mm)
DAC8311IDCKR	SC70	DCK	6	3000	184.0	184.0	50.0
DAC8311IDCKT	SC70	DCK	6	250	184.0	184.0	50.0
DAC8411IDCKR	SC70	DCK	6	3000	184.0	184.0	50.0
DAC8411IDCKT	SC70	DCK	6	250	184.0	184.0	50.0

DCK (R-PDSO-G6)

PLASTIC SMALL-OUTLINE PACKAGE



- NOTES:
- A. All linear dimensions are in millimeters.
  - B. This drawing is subject to change without notice.
  - C. Body dimensions do not include mold flash or protrusion. Mold flash and protrusion shall not exceed 0.15 per side.
  - D. Falls within JEDEC MO-203 variation AB.

DCK (R-PDSO-G6)

PLASTIC SMALL OUTLINE



- NOTES:
- A. All linear dimensions are in millimeters.
  - B. This drawing is subject to change without notice.
  - C. Customers should place a note on the circuit board fabrication drawing not to alter the center solder mask defined pad.
  - D. Publication IPC-7351 is recommended for alternate designs.
  - E. Laser cutting apertures with trapezoidal walls and also rounding corners will offer better paste release. Customers should contact their board assembly site for stencil design recommendations. Example stencil design based on a 50% volumetric metal load solder paste. Refer to IPC-7525 for other stencil recommendations.

## IMPORTANT NOTICE

Texas Instruments Incorporated and its subsidiaries (TI) reserve the right to make corrections, enhancements, improvements and other changes to its semiconductor products and services per JESD46, latest issue, and to discontinue any product or service per JESD48, latest issue. Buyers should obtain the latest relevant information before placing orders and should verify that such information is current and complete. All semiconductor products (also referred to herein as "components") are sold subject to TI's terms and conditions of sale supplied at the time of order acknowledgment.

TI warrants performance of its components to the specifications applicable at the time of sale, in accordance with the warranty in TI's terms and conditions of sale of semiconductor products. Testing and other quality control techniques are used to the extent TI deems necessary to support this warranty. Except where mandated by applicable law, testing of all parameters of each component is not necessarily performed.

TI assumes no liability for applications assistance or the design of Buyers' products. Buyers are responsible for their products and applications using TI components. To minimize the risks associated with Buyers' products and applications, Buyers should provide adequate design and operating safeguards.

TI does not warrant or represent that any license, either express or implied, is granted under any patent right, copyright, mask work right, or other intellectual property right relating to any combination, machine, or process in which TI components or services are used. Information published by TI regarding third-party products or services does not constitute a license to use such products or services or a warranty or endorsement thereof. Use of such information may require a license from a third party under the patents or other intellectual property of the third party, or a license from TI under the patents or other intellectual property of TI.

Reproduction of significant portions of TI information in TI data books or data sheets is permissible only if reproduction is without alteration and is accompanied by all associated warranties, conditions, limitations, and notices. TI is not responsible or liable for such altered documentation. Information of third parties may be subject to additional restrictions.

Resale of TI components or services with statements different from or beyond the parameters stated by TI for that component or service voids all express and any implied warranties for the associated TI component or service and is an unfair and deceptive business practice. TI is not responsible or liable for any such statements.

Buyer acknowledges and agrees that it is solely responsible for compliance with all legal, regulatory and safety-related requirements concerning its products, and any use of TI components in its applications, notwithstanding any applications-related information or support that may be provided by TI. Buyer represents and agrees that it has all the necessary expertise to create and implement safeguards which anticipate dangerous consequences of failures, monitor failures and their consequences, lessen the likelihood of failures that might cause harm and take appropriate remedial actions. Buyer will fully indemnify TI and its representatives against any damages arising out of the use of any TI components in safety-critical applications.

In some cases, TI components may be promoted specifically to facilitate safety-related applications. With such components, TI's goal is to help enable customers to design and create their own end-product solutions that meet applicable functional safety standards and requirements. Nonetheless, such components are subject to these terms.

No TI components are authorized for use in FDA Class III (or similar life-critical medical equipment) unless authorized officers of the parties have executed a special agreement specifically governing such use.

Only those TI components which TI has specifically designated as military grade or "enhanced plastic" are designed and intended for use in military/aerospace applications or environments. Buyer acknowledges and agrees that any military or aerospace use of TI components which have **not** been so designated is solely at the Buyer's risk, and that Buyer is solely responsible for compliance with all legal and regulatory requirements in connection with such use.

TI has specifically designated certain components as meeting ISO/TS16949 requirements, mainly for automotive use. In any case of use of non-designated products, TI will not be responsible for any failure to meet ISO/TS16949.

### Products

Audio	<a href="http://www.ti.com/audio">www.ti.com/audio</a>
Amplifiers	<a href="http://amplifier.ti.com">amplifier.ti.com</a>
Data Converters	<a href="http://dataconverter.ti.com">dataconverter.ti.com</a>
DLP® Products	<a href="http://www.dlp.com">www.dlp.com</a>
DSP	<a href="http://dsp.ti.com">dsp.ti.com</a>
Clocks and Timers	<a href="http://www.ti.com/clocks">www.ti.com/clocks</a>
Interface	<a href="http://interface.ti.com">interface.ti.com</a>
Logic	<a href="http://logic.ti.com">logic.ti.com</a>
Power Mgmt	<a href="http://power.ti.com">power.ti.com</a>
Microcontrollers	<a href="http://microcontroller.ti.com">microcontroller.ti.com</a>
RFID	<a href="http://www.ti-rfid.com">www.ti-rfid.com</a>
OMAP Applications Processors	<a href="http://www.ti.com/omap">www.ti.com/omap</a>
Wireless Connectivity	<a href="http://www.ti.com/wirelessconnectivity">www.ti.com/wirelessconnectivity</a>

### Applications

Automotive and Transportation	<a href="http://www.ti.com/automotive">www.ti.com/automotive</a>
Communications and Telecom	<a href="http://www.ti.com/communications">www.ti.com/communications</a>
Computers and Peripherals	<a href="http://www.ti.com/computers">www.ti.com/computers</a>
Consumer Electronics	<a href="http://www.ti.com/consumer-apps">www.ti.com/consumer-apps</a>
Energy and Lighting	<a href="http://www.ti.com/energy">www.ti.com/energy</a>
Industrial	<a href="http://www.ti.com/industrial">www.ti.com/industrial</a>
Medical	<a href="http://www.ti.com/medical">www.ti.com/medical</a>
Security	<a href="http://www.ti.com/security">www.ti.com/security</a>
Space, Avionics and Defense	<a href="http://www.ti.com/space-avionics-defense">www.ti.com/space-avionics-defense</a>
Video and Imaging	<a href="http://www.ti.com/video">www.ti.com/video</a>

### TI E2E Community

[e2e.ti.com](http://e2e.ti.com)