



Standard 0603 SMD LED



18562

DESCRIPTION

The new 0603 LED series have been designed in the smallest SMD package. This innovative 0603 LED technology opens the way to

- smaller products of higher performance
- more design in flexibility
- enhanced applications

The 0603 LED is an obvious solution for small-scale, high power products that are expected to work reliability in an arduous environment.

PRODUCT GROUP AND PACKAGE DATA

- Product group: LED
- Package: SMD 0603
- Product series: standard
- Angle of half intensity: $\pm 80^\circ$

FEATURES

- Smallest SMD package 0603 with exceptional brightness
1.6 mm x 0.8 mm x 0.6 mm (L x W x H)
- High reliability lead frame based
- Temperature range -40 °C to +100 °C
- Footprint compatible to 0603 chipled
- Wavelength 466 nm (blue), 570 nm (green), 561 nm (pure green), 589 nm (yellow), 606 nm (orange), 633 nm (red)
- AllnGaP and GaN technology
- Viewing angle: extremely wide 160°
- Grouping parameter: luminous intensity, wavelength
- Available in 8 mm tape
- Compatible to IR reflow soldering
- Preconditioning according to JEDEC® level 2
- AEC-Q101 qualified
- Material categorization: for definitions of compliance please see www.vishay.com/doc?99912

AUTOMOTIVE GRADE



RoHS COMPLIANT
HALOGEN FREE
GREEN (5-2008)

APPLICATIONS

- Backlight keypads
- Navigation systems
- Cellular phone displays
- Displays for industrial control systems
- Automotive features
- Miniaturized color effects
- Traffic displays

PARTS TABLE														
PART	COLOR	LUMINOUS INTENSITY (mcd)			at I _F (mA)	WAVELENGTH (nm)			at I _F (mA)	FORWARD VOLTAGE (V)			at I _F (mA)	TECHNOLOGY
		MIN.	TYP.	MAX.		MIN.	TYP.	MAX.		MIN.	TYP.	MAX.		
TLMS1100-GS08	Red	32	63	-	20	627	633	639	20	-	2.1	3.0	20	AllnGaP
TLMO1100-GS08	Orange	50	80	-	20	600	606	609	20	-	2.1	3.0	20	AllnGaP
TLMY1100-GS08	Yellow	50	80	-	20	580	589	595	20	-	2.1	3.0	20	AllnGaP
TLMG1100-GS08	Green	12.5	35	-	20	564	570	575	20	-	2.1	3.0	20	AllnGaP
TLMP1100-GS08	Pure green	6.3	15	-	20	551	561	566	20	-	2.1	3.0	20	AllnGaP
TLMB1100-GS08	Blue	4	5	-	10	-	466	-	10	-	3.9	4.5	10	GaN



ABSOLUTE MAXIMUM RATINGS ($T_{amb} = 25\text{ }^{\circ}\text{C}$, unless otherwise specified) TLMS1100, TLMO1100, TLMY1100, TLMG1100, TLMP1100				
PARAMETER	TEST CONDITION	SYMBOL	VALUE	UNIT
Reverse voltage ⁽¹⁾		V_R	12	V
DC forward current	$T_{amb} \leq 75\text{ }^{\circ}\text{C}$	I_F	30	mA
Surge forward current	$t_p \leq 10\text{ }\mu\text{s}$	I_{FSM}	0.5	A
Power dissipation		P_V	90	mW
Junction temperature		T_j	+120	$^{\circ}\text{C}$
Operating temperature range		T_{amb}	-40 to +100	$^{\circ}\text{C}$
Storage temperature range		T_{stg}	-40 to +100	$^{\circ}\text{C}$
Soldering temperature	acc. Vishay specification	T_{sd}	+260	$^{\circ}\text{C}$
Thermal resistance junction/ambient	mounted on PC board (pad size > 5 mm ²)	R_{thJA}	480	K/W

Note

⁽¹⁾ Driving the LED in reverse direction is suitable for short term application

ABSOLUTE MAXIMUM RATINGS ($T_{amb} = 25\text{ }^{\circ}\text{C}$, unless otherwise specified) TLMB1100				
PARAMETER	TEST CONDITION	SYMBOL	VALUE	UNIT
Reverse voltage ⁽¹⁾		V_R	5	V
DC forward current	$T_{amb} \leq 60\text{ }^{\circ}\text{C}$	I_F	15	mA
Surge forward current	$t_p \leq 10\text{ }\mu\text{s}$	I_{FSM}	0.1	A
Power dissipation		P_V	68	mW
Junction temperature		T_j	+100	$^{\circ}\text{C}$
Operating temperature range		T_{amb}	-40 to +100	$^{\circ}\text{C}$
Storage temperature range		T_{stg}	-40 to +100	$^{\circ}\text{C}$
Soldering temperature	acc. Vishay specification	T_{sd}	+260	$^{\circ}\text{C}$
Thermal resistance junction/ambient	mounted on PC board (pad size > 5 mm ²)	R_{thJA}	480	K/W

Note

⁽¹⁾ Driving the LED in reverse direction is suitable for short term application

OPTICAL AND ELECTRICAL CHARACTERISTICS ($T_{amb} = 25\text{ }^{\circ}\text{C}$, unless otherwise specified) TLMS1100, RED						
PARAMETER	TEST CONDITION	SYMBOL	MIN.	TYP.	MAX.	UNIT
Luminous intensity	$I_F = 20\text{ mA}$	I_V	32	63	-	mcd
Dominant wavelength	$I_F = 20\text{ mA}$	λ_d	627	633	639	nm
Peak wavelength	$I_F = 20\text{ mA}$	λ_p	-	645	-	nm
Angle of half intensity	$I_F = 20\text{ mA}$	φ	-	± 80	-	deg
Forward voltage	$I_F = 20\text{ mA}$	V_F	-	2.1	3.0	V
Reverse voltage	$I_R = 10\text{ }\mu\text{A}$	V_R	6	-	-	V
Junction capacitance	$V_R = 0\text{ V}$, $f = 1\text{ MHz}$	C_j	-	15	-	pF

OPTICAL AND ELECTRICAL CHARACTERISTICS ($T_{amb} = 25\text{ }^{\circ}\text{C}$, unless otherwise specified) TLMO1100, ORANGE						
PARAMETER	TEST CONDITION	SYMBOL	MIN.	TYP.	MAX.	UNIT
Luminous intensity	$I_F = 20\text{ mA}$	I_V	50	80	-	mcd
Dominant wavelength	$I_F = 20\text{ mA}$	λ_d	600	606	609	nm
Peak wavelength	$I_F = 20\text{ mA}$	λ_p	-	610	-	nm
Angle of half intensity	$I_F = 20\text{ mA}$	φ	-	± 80	-	deg
Forward voltage	$I_F = 20\text{ mA}$	V_F	-	2.1	3.0	V
Reverse voltage	$I_R = 10\text{ }\mu\text{A}$	V_R	6	-	-	V
Junction capacitance	$V_R = 0\text{ V}$, $f = 1\text{ MHz}$	C_j	-	15	-	pF



OPTICAL AND ELECTRICAL CHARACTERISTICS ($T_{amb} = 25\text{ }^{\circ}\text{C}$, unless otherwise specified)						
TLMY1100, YELLOW						
PARAMETER	TEST CONDITION	SYMBOL	MIN.	TYP.	MAX.	UNIT
Luminous intensity	$I_F = 20\text{ mA}$	I_V	50	80	-	mcd
Dominant wavelength	$I_F = 20\text{ mA}$	λ_d	580	589	595	nm
Peak wavelength	$I_F = 20\text{ mA}$	λ_p	-	591	-	nm
Angle of half intensity	$I_F = 20\text{ mA}$	φ	-	± 80	-	deg
Forward voltage	$I_F = 20\text{ mA}$	V_F	-	2.1	3.0	V
Reverse voltage	$I_R = 10\text{ }\mu\text{A}$	V_R	6	-	-	V
Junction capacitance	$V_R = 0\text{ V}$, $f = 1\text{ MHz}$	C_j	-	15	-	pF

OPTICAL AND ELECTRICAL CHARACTERISTICS ($T_{amb} = 25\text{ }^{\circ}\text{C}$, unless otherwise specified)						
TLMG1100, GREEN						
PARAMETER	TEST CONDITION	SYMBOL	MIN.	TYP.	MAX.	UNIT
Luminous intensity	$I_F = 20\text{ mA}$	I_V	12.5	35	-	mcd
Dominant wavelength	$I_F = 20\text{ mA}$	λ_d	564	570	575	nm
Peak wavelength	$I_F = 20\text{ mA}$	λ_p	-	572	-	nm
Angle of half intensity	$I_F = 20\text{ mA}$	φ	-	± 80	-	deg
Forward voltage	$I_F = 20\text{ mA}$	V_F	-	2.1	3.0	V
Reverse voltage	$I_R = 10\text{ }\mu\text{A}$	V_R	6	-	-	V
Junction capacitance	$V_R = 0\text{ V}$, $f = 1\text{ MHz}$	C_j	-	15	-	pF

OPTICAL AND ELECTRICAL CHARACTERISTICS ($T_{amb} = 25\text{ }^{\circ}\text{C}$, unless otherwise specified)						
TLMP1100, PURE GREEN						
PARAMETER	TEST CONDITION	SYMBOL	MIN.	TYP.	MAX.	UNIT
Luminous intensity	$I_F = 20\text{ mA}$	I_V	6.3	15	-	mcd
Dominant wavelength	$I_F = 20\text{ mA}$	λ_d	551	561	566	nm
Peak wavelength	$I_F = 20\text{ mA}$	λ_p	-	562	-	nm
Angle of half intensity	$I_F = 20\text{ mA}$	φ	-	± 80	-	deg
Forward voltage	$I_F = 20\text{ mA}$	V_F	-	2.1	3.0	V
Reverse voltage	$I_R = 10\text{ }\mu\text{A}$	V_R	6	-	-	V
Junction capacitance	$V_R = 0\text{ V}$, $f = 1\text{ MHz}$	C_j	-	15	-	pF

OPTICAL AND ELECTRICAL CHARACTERISTICS ($T_{amb} = 25\text{ }^{\circ}\text{C}$, unless otherwise specified)						
TLMB1100, BLUE						
PARAMETER	TEST CONDITION	SYMBOL	MIN.	TYP.	MAX.	UNIT
Luminous intensity	$I_F = 10\text{ mA}$	I_V	4	5	-	mcd
Dominant wavelength	$I_F = 10\text{ mA}$	λ_d	-	466	-	nm
Peak wavelength	$I_F = 10\text{ mA}$	λ_p	-	428	-	nm
Angle of half intensity	$I_F = 10\text{ mA}$	φ	-	± 80	-	deg
Forward voltage	$I_F = 10\text{ mA}$	V_F	-	3.9	4.5	V
Reverse voltage	$I_R = 10\text{ }\mu\text{A}$	V_R	5	-	-	V



LUMINOUS INTENSITY/FLUX CLASSIFICATION		
GROUP	LUMINOUS INTENSITY I _v (mcd)	
	MIN.	MAX.
Pa	4	6.3
Pb	5	8
Qa	6.3	10
Qb	8	12.5
Ra	10	16
Rb	12.5	20
Sa	16	25
Sb	20	32
Ta	25	40
Tb	32	50
Ua	40	63
Ub	50	80
Va	63	100
Vb	80	125
Wa	100	160
Wb	125	200

Note

- Luminous intensity is tested at a current pulse duration of 25 ms.
The above type numbers represent the order groups which include only a few brightness groups. Only one group will be shipped on each reel (there will be no mixing of two groups on each reel).
In order to ensure availability, single brightness groups will not be orderable.
In a similar manner for colors where wavelength groups are measured and binned, single wavelength groups will be shipped in any one reel.
In order to ensure availability, single wavelength groups will not be orderable.

COLOR CLASSIFICATION										
GROUP	DOM. WAVELENGTH (nm)									
	BLUE		PURE GREEN		GREEN		YELLOW		ORANGE	
	MIN.	MAX.	MIN.	MAX.	MIN.	MAX.	MIN.	MAX.	MIN.	MAX.
- 1	-	-	551	554	564	566	-	-	-	-
- 2	460	464	554	557	566	569	580	583	600	603
- 3	464	468	557	560	569	572	583	586	603	606
- 4	468	472	560	563	572	575	586	589	606	609
- 5	472	476	563	566	-	-	589	592	609	612
- 6	-	-	-	-	-	-	592	595	-	-

Note

- Wavelengths are tested at a current pulse duration of 25 ms and an accuracy of ± 1 nm.

GROUP NAME ON LABEL		
LUMINOUS INTENSITY GROUP	HALFGROUP	WAVELENGTH
Q	b	4

Note

- One packing unit/tape contains only one classification group of luminous intensity, color and forward voltage.
Only one single classification groups is not available.
The given groups are not order codes, customer specific group combinations require marketing agreement.
No color subgrouping for super red.



TYPICAL CHARACTERISTICS (T_{amb} = 25 °C, unless otherwise specified)

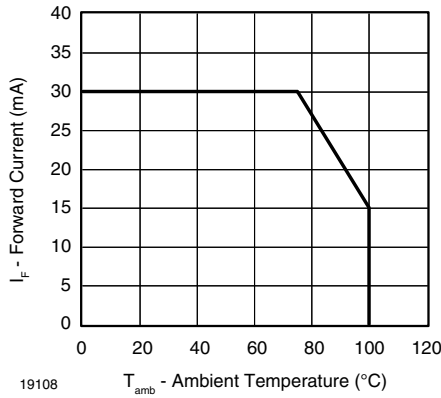

Fig. 1 - Forward Current vs. Ambient Temperature

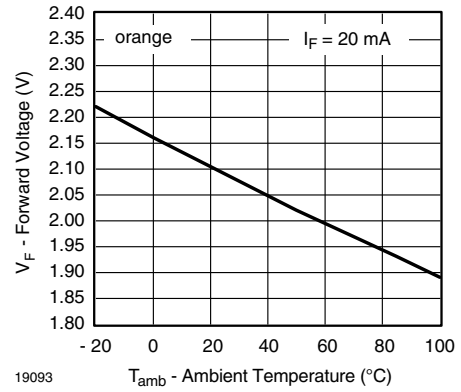

Fig. 4 - Forward Voltage vs. Ambient Temperature

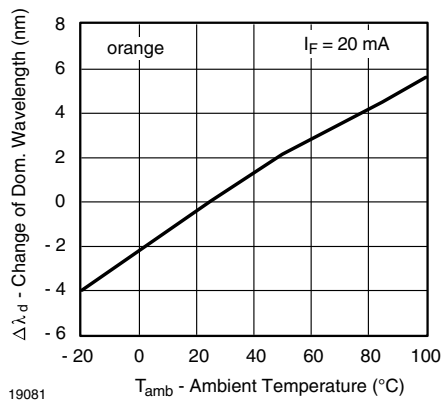

Fig. 2 - Change of Dominant Wavelength vs. Ambient Temperature

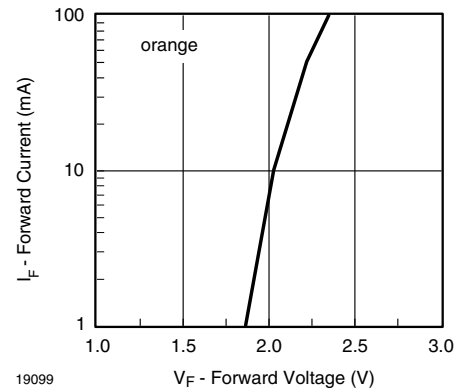

Fig. 5 - Forward Current vs. Forward Voltage

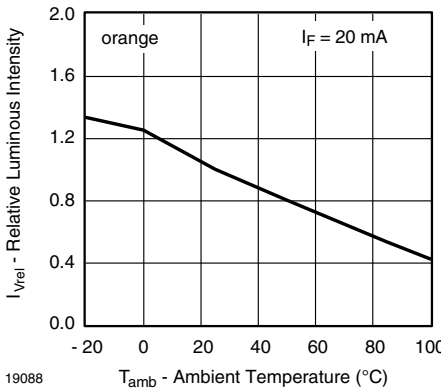

Fig. 3 - Relative Luminous Intensity vs. Ambient Temperature

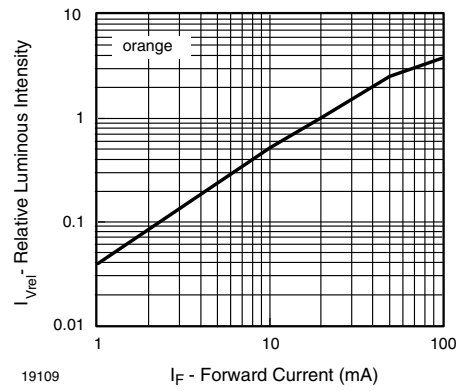

Fig. 6 - Relative Luminous Intensity vs. Forward Current

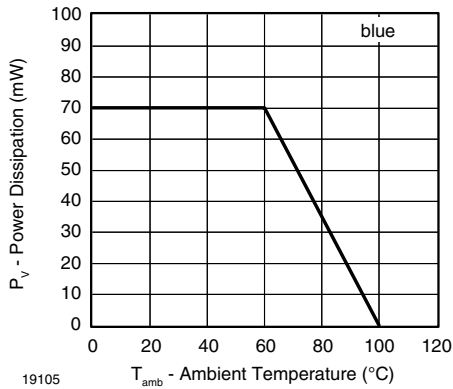

Fig. 7 - Power Dissipation vs. Ambient Temperature

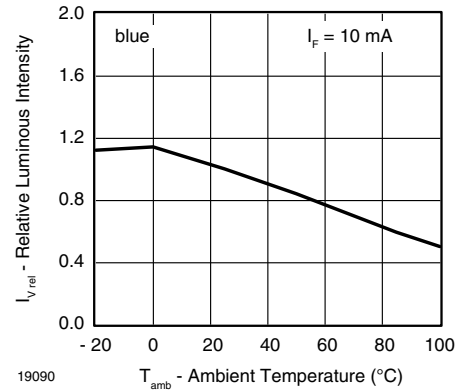

Fig. 10 - Relative Luminous Intensity vs. Ambient Temperature

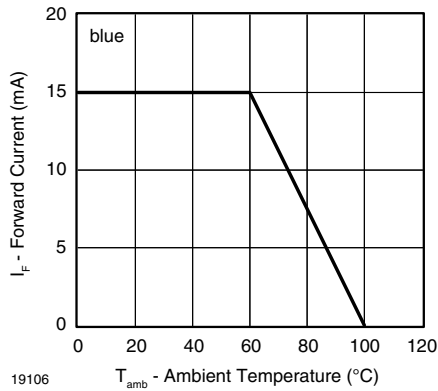

Fig. 8 - Forward Current vs. Ambient Temperature

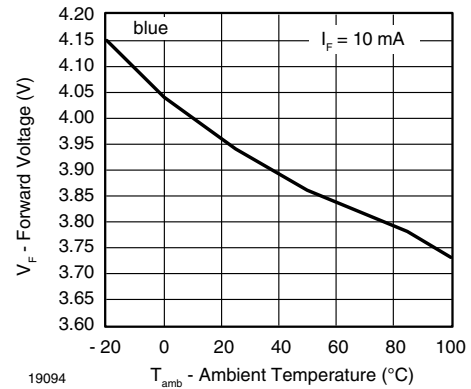

Fig. 11 - Forward Voltage vs. Ambient Temperature

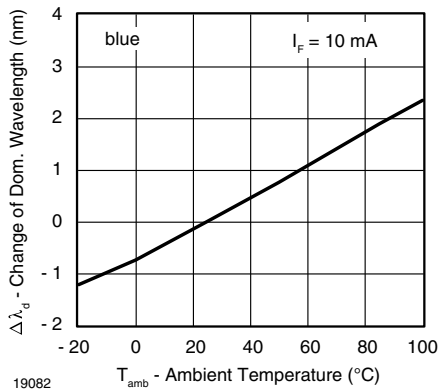

Fig. 9 - Change of Dominant Wavelength vs. Ambient Temperature

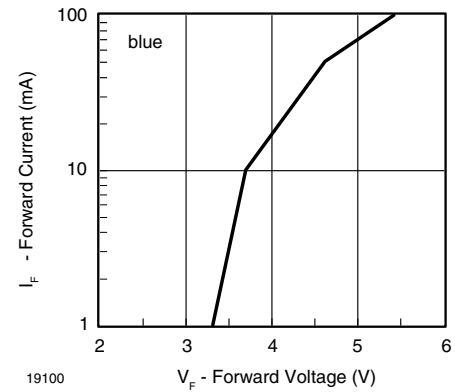

Fig. 12 - Forward Current vs. Forward Voltage

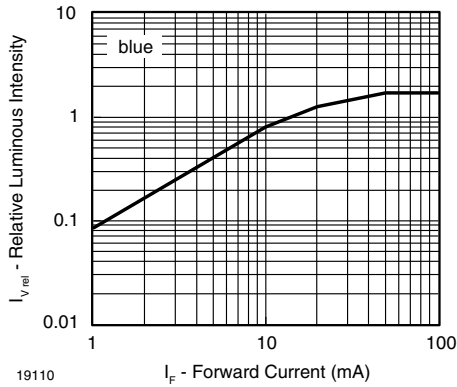

Fig. 13 - Relative Luminous Intensity vs. Forward Current

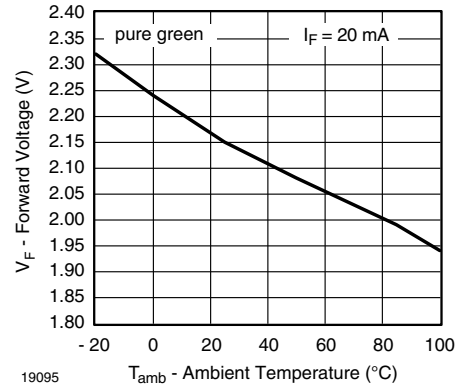

Fig. 16 - Forward Voltage vs. Ambient Temperature

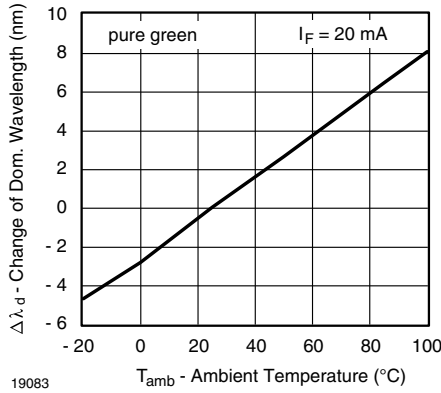

Fig. 14 - Change of Dominant Wavelength vs. Ambient Temperature

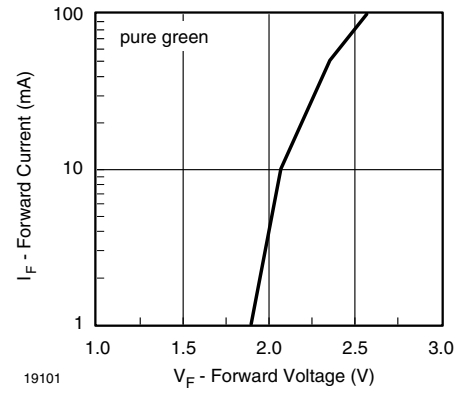

Fig. 17 - Forward Current vs. Forward Voltage

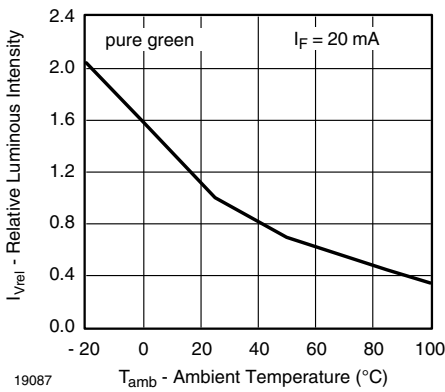

Fig. 15 - Relative Luminous Intensity vs. Ambient Temperature

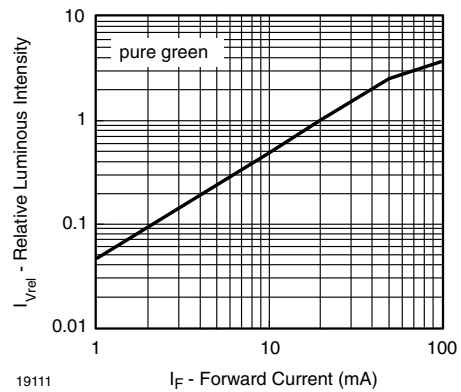

Fig. 18 - Relative Luminous Intensity vs. Forward Current

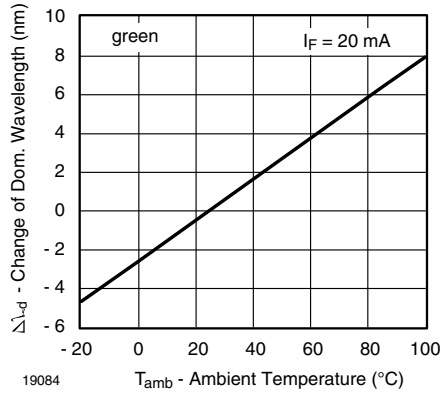

Fig. 19 - Change of Dominant Wavelength vs. Ambient Temperature

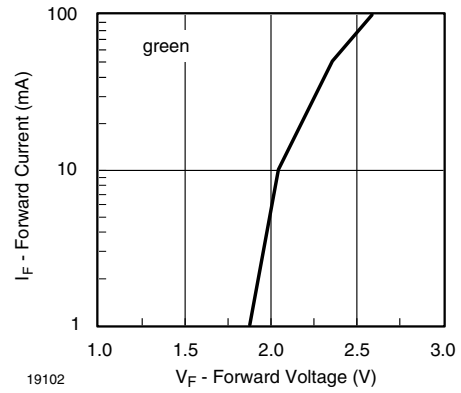

Fig. 22 - Forward Current vs. Forward Voltage

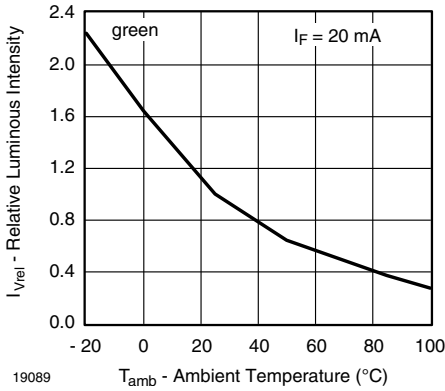

Fig. 20 - Relative Luminous Intensity vs. Ambient Temperature

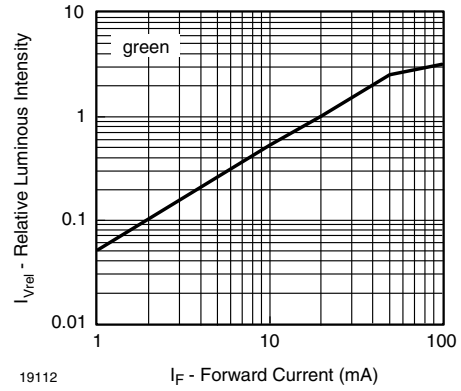

Fig. 23 - Relative Luminous Intensity vs. Forward Current

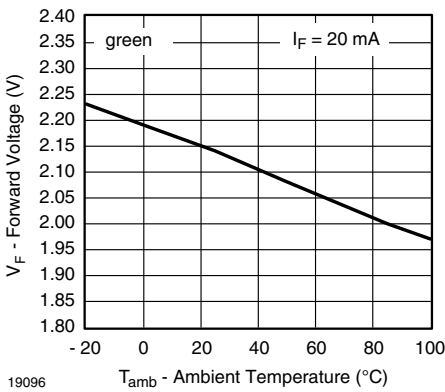

Fig. 21 - Forward Voltage vs. Ambient Temperature

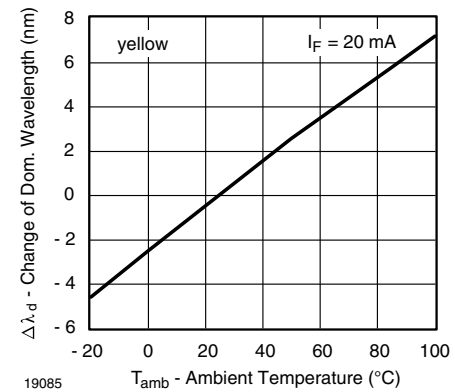

Fig. 24 - Change of Dominant Wavelength vs. Ambient Temperature

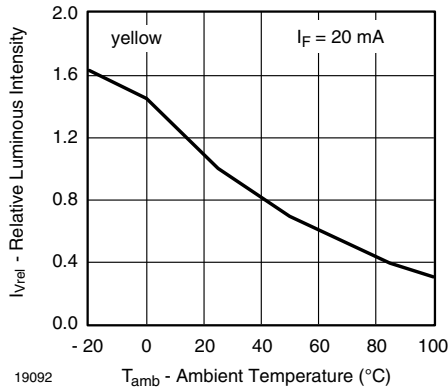

Fig. 25 - Relative Luminous Intensity vs. Ambient Temperature

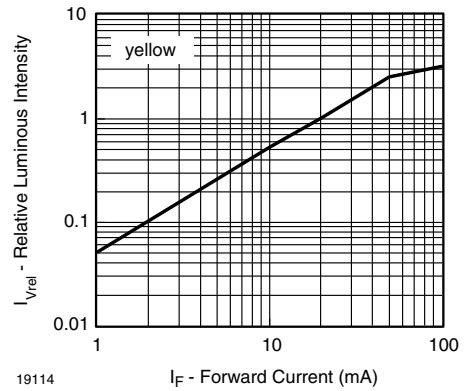

Fig. 28 - Relative Luminous Intensity vs. Forward Current

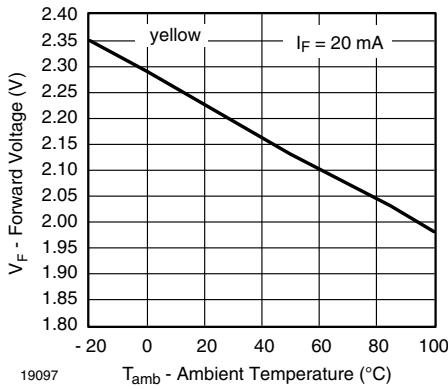

Fig. 26 - Forward Voltage vs. Ambient Temperature

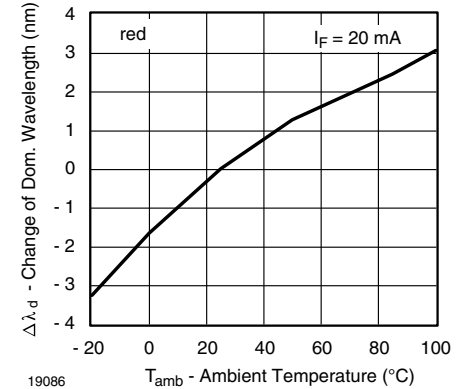

Fig. 29 - Change of Dominant Wavelength vs. Ambient Temperature

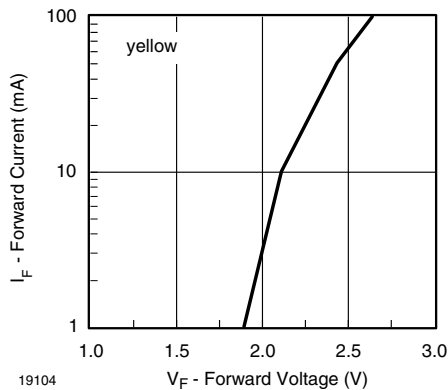

Fig. 27 - Forward Current vs. Forward Voltage

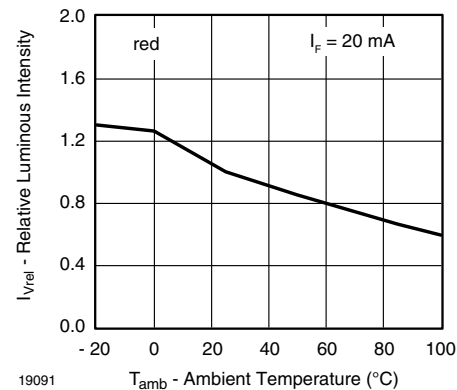

Fig. 30 - Relative Luminous Intensity vs. Ambient Temperature



Fig. 31 - Forward Voltage vs. Ambient Temperature

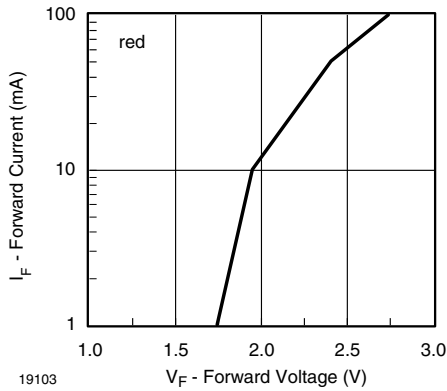

Fig. 32 - Forward Current vs. Forward Voltage



Fig. 33 - Relative Luminous Intensity vs. Forward Current



REEL DIMENSIONS in millimeters

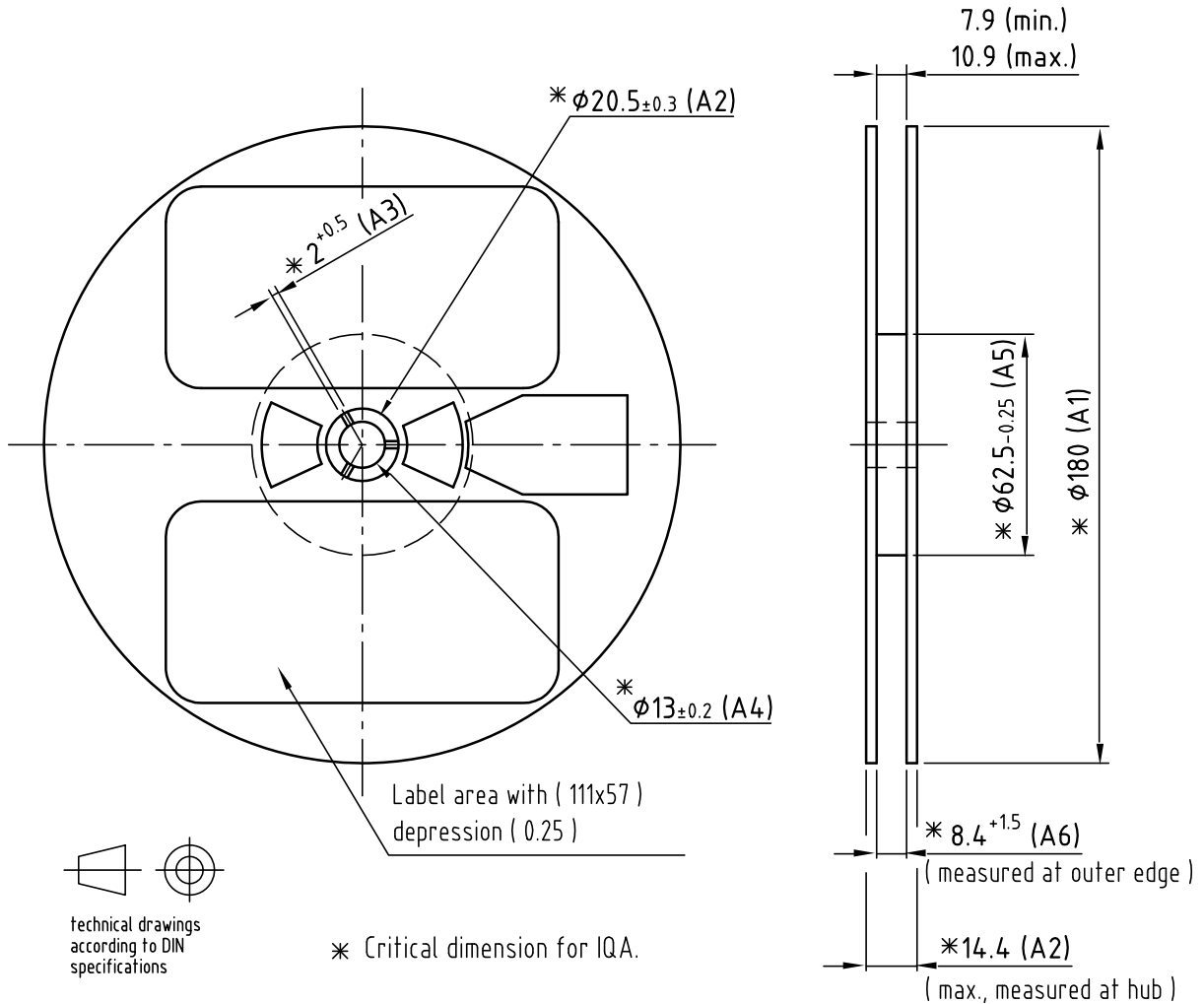

Drawing-No.: 9.800-5086.01-4

Issue: 1; 29.04.04

19043

Not indicated tolerances ± 0.05

Material: black static dissipative



TAPE DIMENSIONS in millimeters

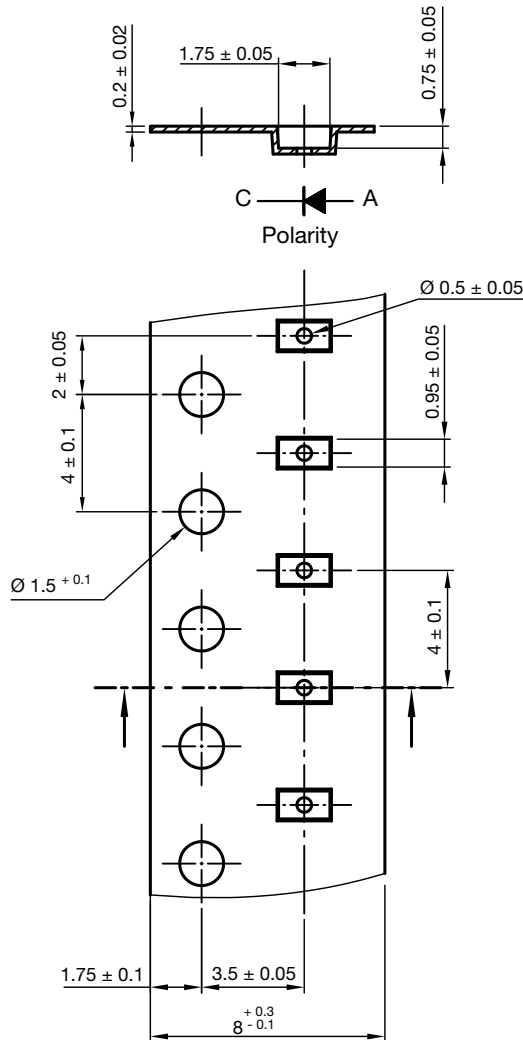

Technical drawings according to DIN specifications

Not indicated tolerances ± 0.05
Material: Conductive black PC

Drawing-No.: 9.700-5290.01-4
Issue: 3; 24.09.13



PACKAGE DIMENSIONS in millimeters

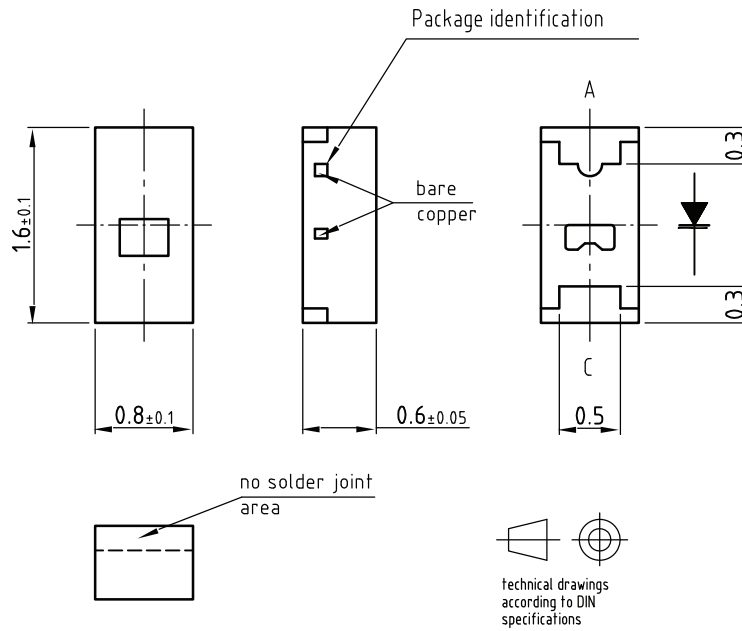

Not indicated tolerances ± 0.1

Recommended solder pad

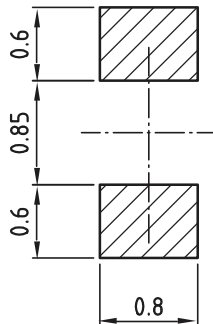

Drawing-No.: 6.541-5056.01-4

Issue: 2; 04.05.05

19426



SOLDERING PROFILE

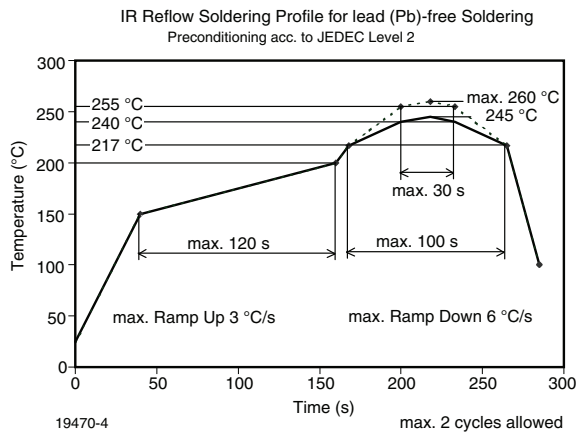
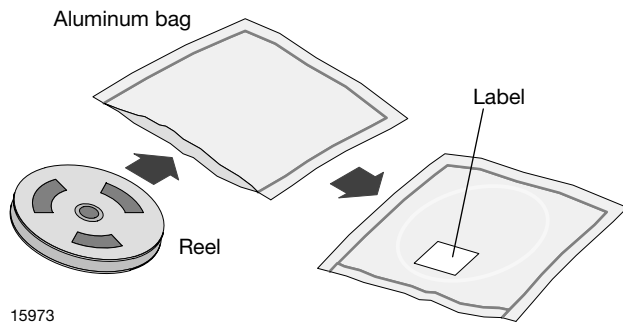

Fig. 34 - Vishay Lead (Pb)-free Reflow Soldering Profile (acc. to J-STD-020C)

DRY PACKING

The reel is packed in an anti-humidity bag to protect the devices from absorbing moisture during transportation and storage.



15973

FINAL PACKING

The sealed reel is packed into a cardboard box. A secondary cardboard box is used for shipping purposes.

RECOMMENDED METHOD OF STORAGE

Dry box storage is recommended as soon as the aluminum bag has been opened to prevent moisture absorption. The following conditions should be observed, if dry boxes are not available:

- Storage temperature 10 °C to 30 °C
- Storage humidity ≤ 60 % RH max.

After more than 1 year under these conditions moisture content will be too high for reflow soldering.

In case of moisture absorption, the devices will recover to the former condition by drying under the following condition: 192 h at 40 °C + 5 °C / - 0 °C and < 5 % RH (dry air / nitrogen) or 96 h at 60 °C + 5 °C and < 5 % RH for all device containers or

24 h at 100 °C + 5 °C not suitable for reel or tubes.

An EIA JEDEC standard JESD22-A112 level 2 label is included on all dry bags.

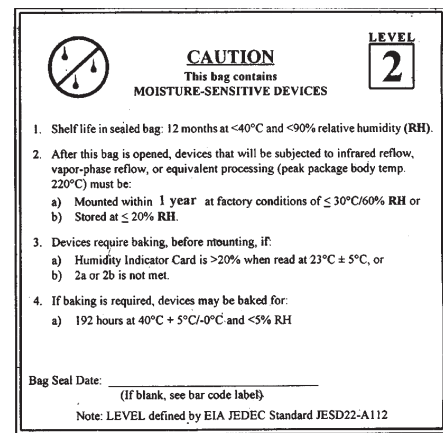

17028

Example of JESD22-A112 level 2 label

ESD PRECAUTION

Proper storage and handling procedures should be followed to prevent ESD damage to the devices especially when they are removed from the antistatic shielding bag. Electrostatic sensitive devices warning labels are on the packaging.

VISHAY SEMICONDUCTORS STANDARD BAR CODE LABELS

The Vishay Semiconductors standard bar code labels are printed at final packing areas. The labels are on each packing unit and contain Vishay Semiconductors specific data.



Disclaimer

ALL PRODUCT, PRODUCT SPECIFICATIONS AND DATA ARE SUBJECT TO CHANGE WITHOUT NOTICE TO IMPROVE RELIABILITY, FUNCTION OR DESIGN OR OTHERWISE.

Vishay Intertechnology, Inc., its affiliates, agents, and employees, and all persons acting on its or their behalf (collectively, "Vishay"), disclaim any and all liability for any errors, inaccuracies or incompleteness contained in any datasheet or in any other disclosure relating to any product.

Vishay makes no warranty, representation or guarantee regarding the suitability of the products for any particular purpose or the continuing production of any product. To the maximum extent permitted by applicable law, Vishay disclaims (i) any and all liability arising out of the application or use of any product, (ii) any and all liability, including without limitation special, consequential or incidental damages, and (iii) any and all implied warranties, including warranties of fitness for particular purpose, non-infringement and merchantability.

Statements regarding the suitability of products for certain types of applications are based on Vishay's knowledge of typical requirements that are often placed on Vishay products in generic applications. Such statements are not binding statements about the suitability of products for a particular application. It is the customer's responsibility to validate that a particular product with the properties described in the product specification is suitable for use in a particular application. Parameters provided in datasheets and / or specifications may vary in different applications and performance may vary over time. All operating parameters, including typical parameters, must be validated for each customer application by the customer's technical experts. Product specifications do not expand or otherwise modify Vishay's terms and conditions of purchase, including but not limited to the warranty expressed therein.

Except as expressly indicated in writing, Vishay products are not designed for use in medical, life-saving, or life-sustaining applications or for any other application in which the failure of the Vishay product could result in personal injury or death. Customers using or selling Vishay products not expressly indicated for use in such applications do so at their own risk. Please contact authorized Vishay personnel to obtain written terms and conditions regarding products designed for such applications.

No license, express or implied, by estoppel or otherwise, to any intellectual property rights is granted by this document or by any conduct of Vishay. Product names and markings noted herein may be trademarks of their respective owners.