

## “Half Bridge” High Speed IGBT INT-A-PAK, 200 A

**INT-A-PAK IGBT**

### FEATURES

- Trench IGBT technology
- Gen 4 FRED Pt<sup>®</sup> anti-parallel diodes with ultra soft reverse recovery characteristics
- Very low switching losses
- Al<sub>2</sub>O<sub>3</sub> DBC
- UL approved file E78996 
- Designed for industrial level
- Material categorization: for definitions of compliance please see [www.vishay.com/doc?99912](http://www.vishay.com/doc?99912)

**RoHS  
COMPLIANT**

### BENEFITS

- Optimized for high current inverter stages
- Direct mounting on heatsink
- Very low junction to case thermal resistance
- Low EMI

### PRIMARY CHARACTERISTICS

$V_{CES}$	650 V
$I_C$ (DC) at $T_C = 80\text{ }^\circ\text{C}$	144 A
$V_{CE(on)}$ (typical) at $I_C = 200\text{ A}$ , $T_J = 25\text{ }^\circ\text{C}$	1.83 V
Chip level $V_{CE(on)}$ at 200 A, 25 °C	1.70 V
Speed	8 kHz to 30 kHz
Package	INT-A-PAK
Circuit configuration	Half bridge

### ABSOLUTE MAXIMUM RATINGS

PARAMETER	SYMBOL	TEST CONDITIONS	MAX.	UNITS
Collector to emitter voltage	$V_{CES}$		650	V
Continuous collector current	$I_C$	$T_C = 25\text{ }^\circ\text{C}$	193	A
		$T_C = 80\text{ }^\circ\text{C}$	144	
Pulsed collector current	$I_{CM}$	$T_J = 175\text{ }^\circ\text{C}$ , $t_p = 6\text{ ms}$ , $V_{GE} = 15\text{ V}$	450	
Clamped inductive load current	$I_{LM}$		405	
Diode continuous forward current	$I_F$	$T_C = 25\text{ }^\circ\text{C}$	144	
		$T_C = 80\text{ }^\circ\text{C}$	108	
Maximum non-repetitive peak current	$I_{FSM}$	10 ms sine or 6 ms rectangular pulse	1080	
Gate to emitter voltage	$V_{GE}$		$\pm 20$	V
Maximum power dissipation (IGBT)	$P_D$	$T_C = 25\text{ }^\circ\text{C}$	517	W
		$T_C = 80\text{ }^\circ\text{C}$	328	
Maximum power dissipation (Diode)	$P_D$	$T_C = 25\text{ }^\circ\text{C}$	366	
		$T_C = 80\text{ }^\circ\text{C}$	232	
RMS isolation voltage	$V_{ISOL}$	Any terminal to case, $t = 1\text{ min}$	2500	V
Operating junction temperature range	$T_J$		-40 to +175	$^\circ\text{C}$
Storage temperature range	$T_{STG}$		-40 to +150	$^\circ\text{C}$



<b>ELECTRICAL SPECIFICATIONS</b> ( $T_J = 25\text{ }^\circ\text{C}$ unless otherwise noted)						
PARAMETER	SYMBOL	TEST CONDITIONS	MIN.	TYP.	MAX.	UNITS
Collector to emitter breakdown voltage	$V_{(BR)CES}$	$V_{GE} = 0\text{ V}, I_C = 400\text{ }\mu\text{A}$	650	-	-	
Collector to emitter voltage	$V_{CE(on)}$	$V_{GE} = 15\text{ V}, I_C = 100\text{ A}$	-	1.46	-	V
		$V_{GE} = 15\text{ V}, I_C = 200\text{ A}$	-	1.83	2.3	
		$V_{GE} = 15\text{ V}, I_C = 100\text{ A}, T_J = 125\text{ }^\circ\text{C}$	-	1.59	-	
		$V_{GE} = 15\text{ V}, I_C = 200\text{ A}, T_J = 125\text{ }^\circ\text{C}$	-	2.13	-	
Gate threshold voltage	$V_{GE(th)}$	$V_{CE} = V_{GE}, I_C = 2.0\text{ mA}$	3	3.9	5	
Temperature coefficient of threshold voltage	$\Delta V_{GE(th)}/\Delta T_J$	$V_{CE} = V_{GE}, I_C = 2.0\text{ mA}$ ( $25\text{ }^\circ\text{C}$ to $125\text{ }^\circ\text{C}$ )	-	-10	-	mV/ $^\circ\text{C}$
Forward transconductance	$g_{fe}$	$V_{CE} = 20\text{ V}, I_C = 200\text{ A}$	-	238	-	S
Transfer characteristics	$V_{GE}$	$V_{CE} = 20\text{ V}, I_C = 200\text{ A}$	-	6.3	-	V
Collector to emitter leakage current	$I_{CES}$	$V_{GE} = 0\text{ V}, V_{CE} = 650\text{ V}$	-	0.2	100	$\mu\text{A}$
		$V_{GE} = 0\text{ V}, V_{CE} = 650\text{ V}, T_J = 125\text{ }^\circ\text{C}$	-	0.1	-	mA
Diode forward voltage drop	$V_{FM}$	$I_{FM} = 100\text{ A}$	-	1.73	2.5	V
		$I_{FM} = 200\text{ A}$	-	2.05	-	
		$I_{FM} = 100\text{ A}, T_J = 125\text{ }^\circ\text{C}$	-	1.37	-	
		$I_{FM} = 200\text{ A}, T_J = 125\text{ }^\circ\text{C}$	-	1.75	-	
Gate to emitter leakage current	$I_{GES}$	$V_{GE} = \pm 20\text{ V}$	-	-	240	nA

<b>SWITCHING CHARACTERISTICS</b>								
PARAMETER	SYMBOL	TEST CONDITIONS	MIN.	TYP.	MAX.	UNITS		
Total gate charge (turn-on)	$Q_g$	$I_C = 200\text{ A}$ $V_{CC} = 520\text{ V}$ $V_{GE} = 15\text{ V}$	-	488	-	nC		
Gate to emitter charge (turn-on)	$Q_{ge}$		-	58	-			
Gate to collector (turn-on)	$Q_{gc}$		-	137	-			
Turn-on switching loss	$E_{on}$	$V_{CC} = 325\text{ V}, I_C = 200\text{ A}, R_g = 27\text{ }\Omega,$ $L = 500\text{ }\mu\text{H}, V_{GE} = \pm 15\text{ V}$	-	2.34	-	mJ		
Turn-off switching loss	$E_{off}$		-	3.77	-			
Total switching loss	$E_{tot}$		-	6.11	-			
Turn-on delay time	$t_{d(on)}$		$V_{CC} = 325\text{ V}, I_C = 200\text{ A}, R_g = 27\text{ }\Omega,$ $L = 500\text{ }\mu\text{H}, V_{GE} = \pm 15\text{ V}$ $T_J = 125\text{ }^\circ\text{C}$	-	111	-	ns	
Rise time	$t_r$			-	120	-		
Turn-off delay time	$t_{d(off)}$			-	454	-		
Fall time	$t_f$			-	64	-		
Turn-on switching loss	$E_{on}$			-	2.82	-		mJ
Turn-off switching loss	$E_{off}$			-	3.86	-		
Total switching loss	$E_{tot}$			-	6.68	-		
Turn-on delay time	$t_{d(on)}$	$V_{CC} = 325\text{ V}, I_C = 200\text{ A}, R_g = 27\text{ }\Omega,$ $L = 500\text{ }\mu\text{H}, V_{GE} = \pm 15\text{ V}$ $T_J = 125\text{ }^\circ\text{C}$	-	79	-	ns		
Rise time	$t_r$		-	82	-			
Turn-off delay time	$t_{d(off)}$		-	306	-			
Fall time	$t_f$		-	34	-			
Reverse bias safe operating area	RBSOA	$I_C = 405\text{ A}, R_g = 27\text{ }\Omega, V_{CC} = 325\text{ V},$ $V_p = 650\text{ V}, V_{GE} = 15\text{ V to } -5\text{ V}, T_J = 175\text{ }^\circ\text{C}$	Fullsquare					
Diode reverse recovery time	$t_{rr}$	$I_F = 50\text{ A}, di_F/dt = 500\text{ A}/\mu\text{s}$ $V_{rr} = 200\text{ V}, T_J = 25\text{ }^\circ\text{C}$	-	72	-	ns		
Diode peak reverse current	$I_{rr}$		-	13	-	A		
Diode recovery charge	$Q_{rr}$		-	466	-	nC		
Diode reverse recovery time	$t_{rr}$	$I_F = 50\text{ A}, di_F/dt = 500\text{ A}/\mu\text{s}$ $V_{rr} = 200\text{ V}, T_J = 125\text{ }^\circ\text{C}$	-	146	-	ns		
Diode peak reverse current	$I_{rr}$		-	28	-	A		
Diode recovery charge	$Q_{rr}$		-	2064	-	nC		



THERMAL AND MECHANICAL SPECIFICATIONS						
PARAMETER	SYMBOL	TEST CONDITIONS	MIN.	TYP.	MAX.	UNITS
Operating junction temperature range	$T_J$		-40	-	175	°C
Storage temperature range	$T_{Stg}$		-40	-	150	
Junction to case per leg	IGBT		-	-	0.29	°C/W
	Diode					
Case to sink per module (conductive grease applied)	$R_{thCS}$		-	0.05	-	
Mounting torque	case to heatsink		-	-	4	
	case to terminal 1, 2, 3		-	-	3	
Weight			-	150	-	g

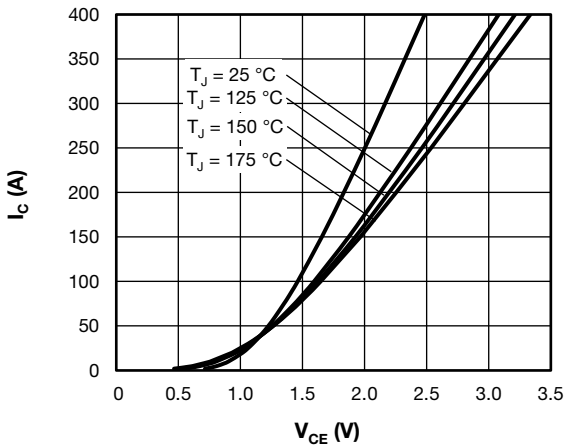

Fig. 1 - Typical Trench IGBT Output Characteristics,  $V_{GE} = 15\text{ V}$

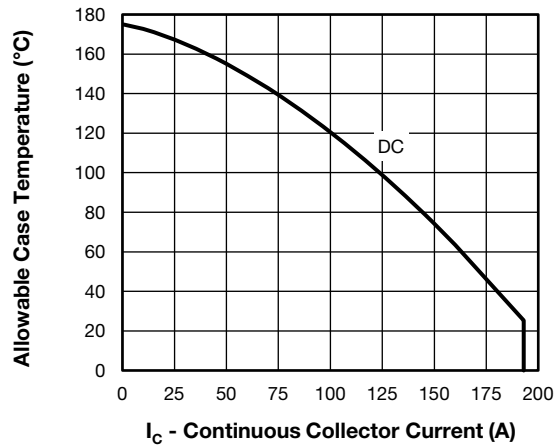

Fig. 3 - Maximum Trench IGBT Continuous Collector Current vs. Case Temperature

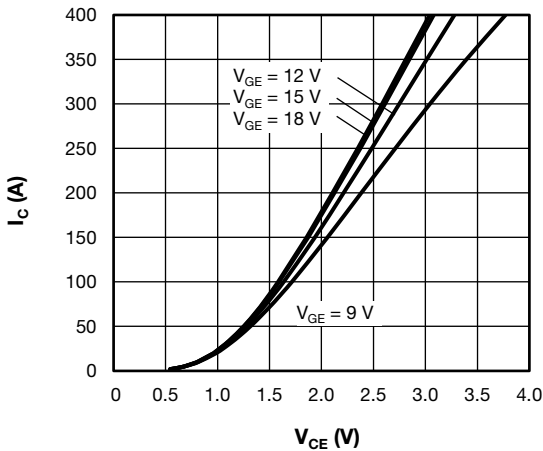

Fig. 2 - Typical Trench IGBT Output Characteristics,  $T_J = 125\text{ °C}$

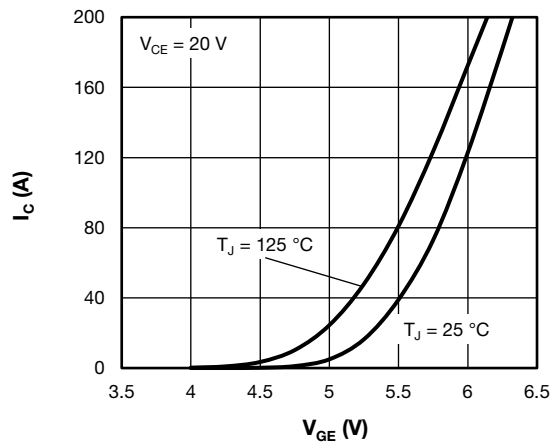

Fig. 4 - Typical Trench IGBT Transfer Characteristics

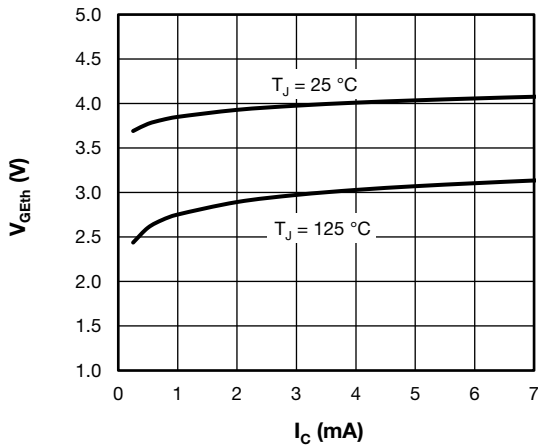

Fig. 5 - Typical Trench IGBT Gate Threshold Voltage

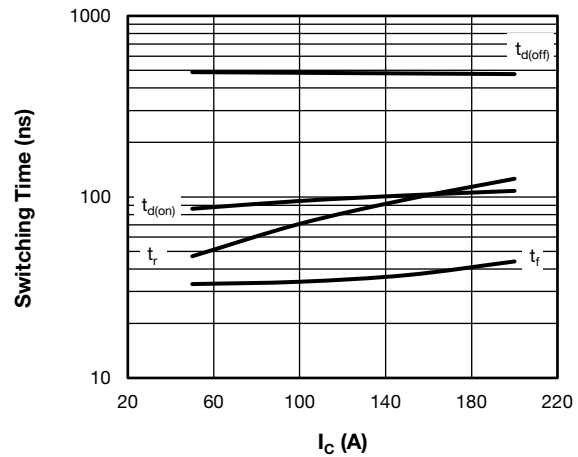

Fig. 8 - Typical Trench IGBT Switching Time vs.  $I_C$   
(with Antiparallel Diode)  
 $T_J = 125\text{ }^\circ\text{C}$ ,  $V_{CC} = 325\text{ V}$ ,  $R_g = 27\text{ }\Omega$ ,  $V_{GE} = +15\text{ V}/-15\text{ V}$ ,  $L = 500\text{ }\mu\text{H}$

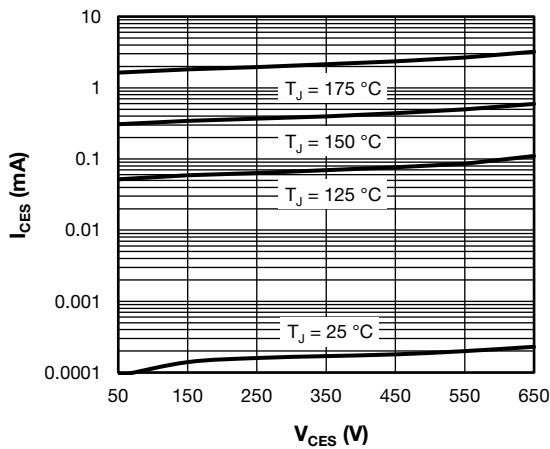

Fig. 6 - Typical Trench IGBT Zero Gate Voltage Collector Current

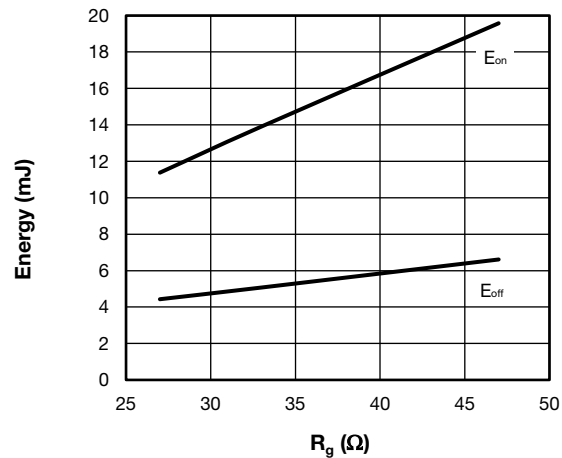

Fig. 9 - Typical Trench IGBT Energy Loss vs.  $R_g$   
(with Antiparallel Diode)  
 $T_J = 125\text{ }^\circ\text{C}$ ,  $V_{CC} = 325\text{ V}$ ,  $I_C = 200\text{ A}$ ,  $V_{GE} = +15\text{ V}/-15\text{ V}$ ,  $L = 500\text{ }\mu\text{H}$

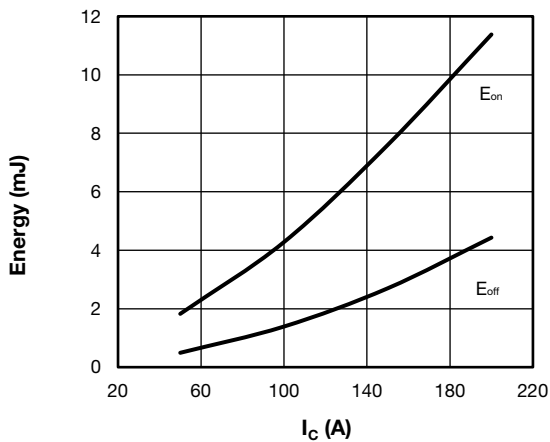

Fig. 7 - Typical Trench IGBT Energy Loss vs.  $I_C$   
(with Antiparallel Diode)  
 $T_J = 125\text{ }^\circ\text{C}$ ,  $V_{CC} = 325\text{ V}$ ,  $R_g = 27\text{ }\Omega$ ,  $V_{GE} = +15\text{ V}/-15\text{ V}$ ,  $L = 500\text{ }\mu\text{H}$

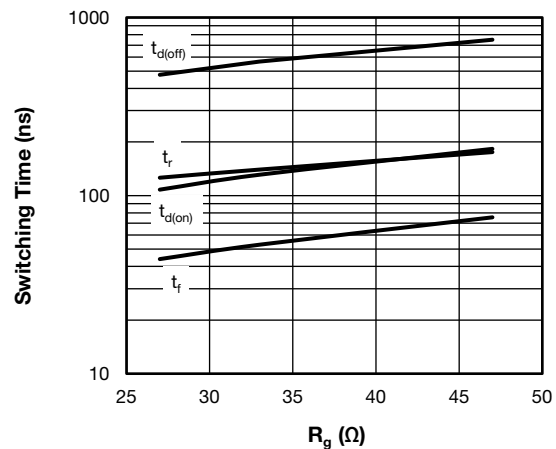

Fig. 10 - Typical Trench IGBT Switching Time vs.  $R_g$   
(with Antiparallel Diode)  
 $T_J = 125\text{ }^\circ\text{C}$ ,  $V_{CC} = 325\text{ V}$ ,  $I_C = 200\text{ A}$ ,  $V_{GE} = +15\text{ V}/-15\text{ V}$ ,  $L = 500\text{ }\mu\text{H}$

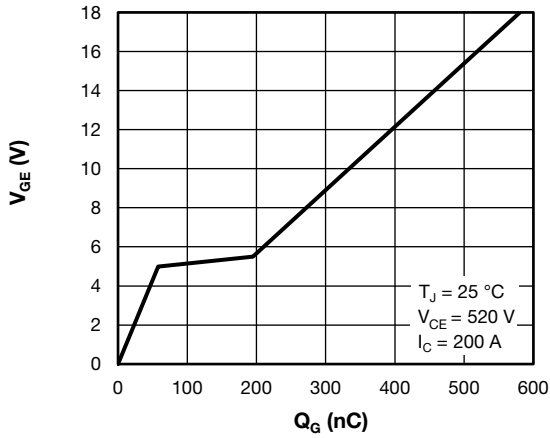

Fig. 11 - Typical Trench IGBT Gate Charge vs. Gate to Collector Voltage

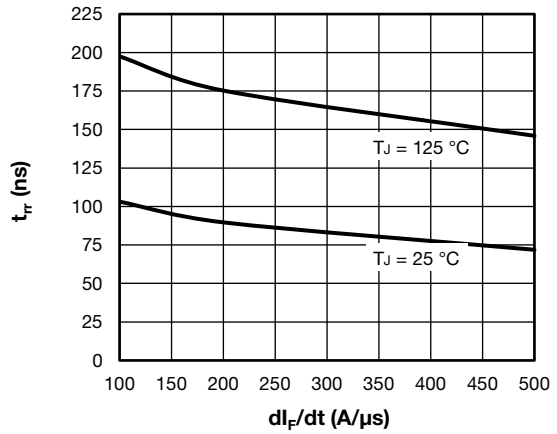

Fig. 14 - Typical Antiparallel Diode Reverse Recovery Time vs.  $di_F/dt$   
 $I_F = 50 \text{ A}, V_{CC} = 200 \text{ V}$

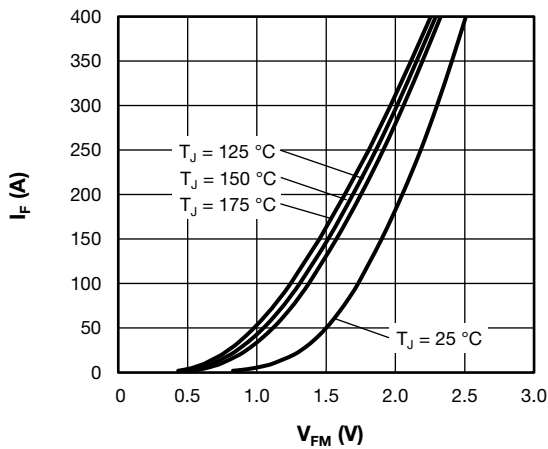

Fig. 12 - Typical Antiparallel Diode Forward Characteristics

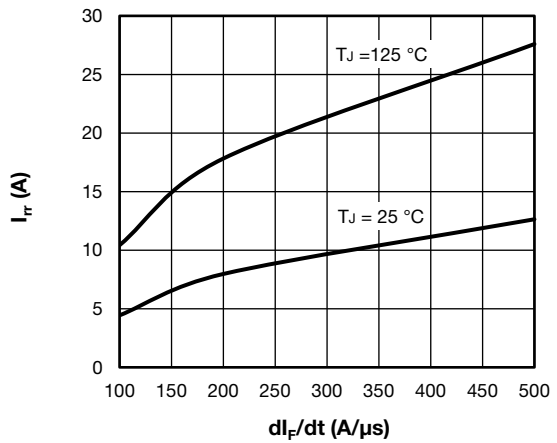

Fig. 15 - Typical Antiparallel Diode Reverse Recovery Current vs.  $di_F/dt$   
 $I_F = 50 \text{ A}, V_{CC} = 200 \text{ V}$

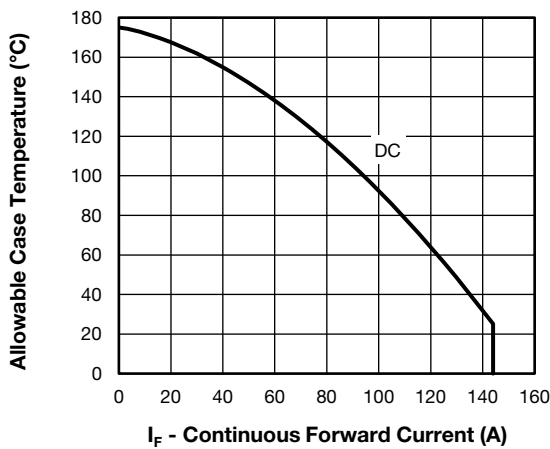

Fig. 13 - Maximum Antiparallel Diode Continuous Forward Current vs. Case Temperature

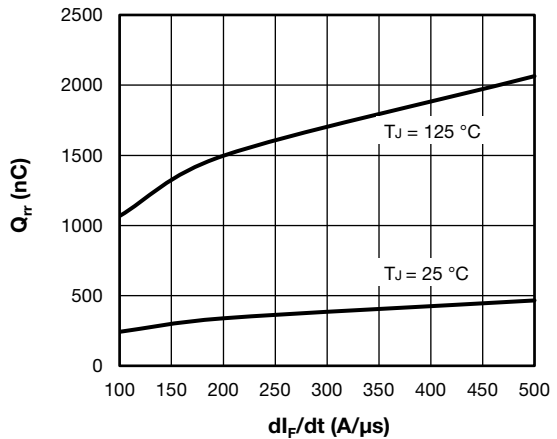

Fig. 16 - Typical Antiparallel Diode Reverse Recovery Charge vs.  $di_F/dt$   
 $I_F = 50 \text{ A}, V_{CC} = 200 \text{ V}$

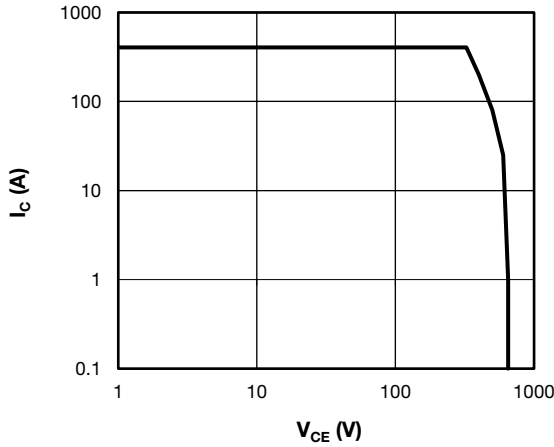

Fig. 17 - Trench IGBT Reverse BIAS SOA  
 $T_J = 175\text{ }^\circ\text{C}$ ,  $I_C = 405\text{ A}$ ,  $R_g = 27\text{ }\Omega$ ,  $V_{GE} = +15\text{ V}/-5\text{ V}$ ,  $V_{CC} = 325\text{ V}$ ,  
 $V_p = 650\text{ V}$

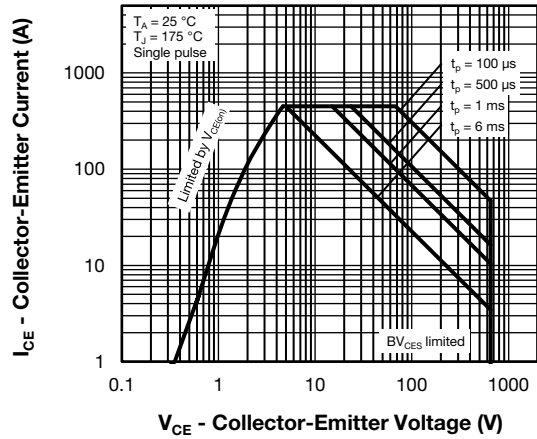

Fig. 18 - Trench IGBT Safe Operating Area

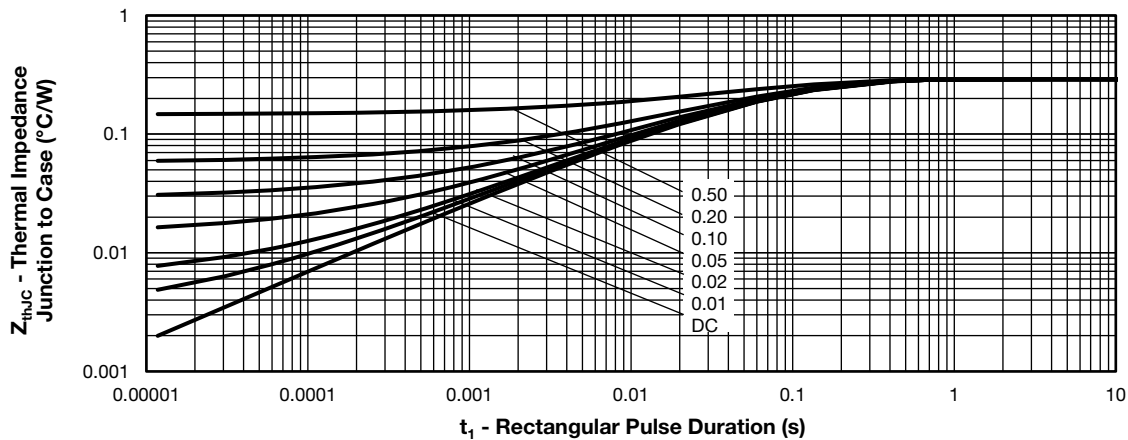

Fig. 19 - Maximum Trench IGBT Thermal Impedance  $Z_{thJC}$  Characteristics

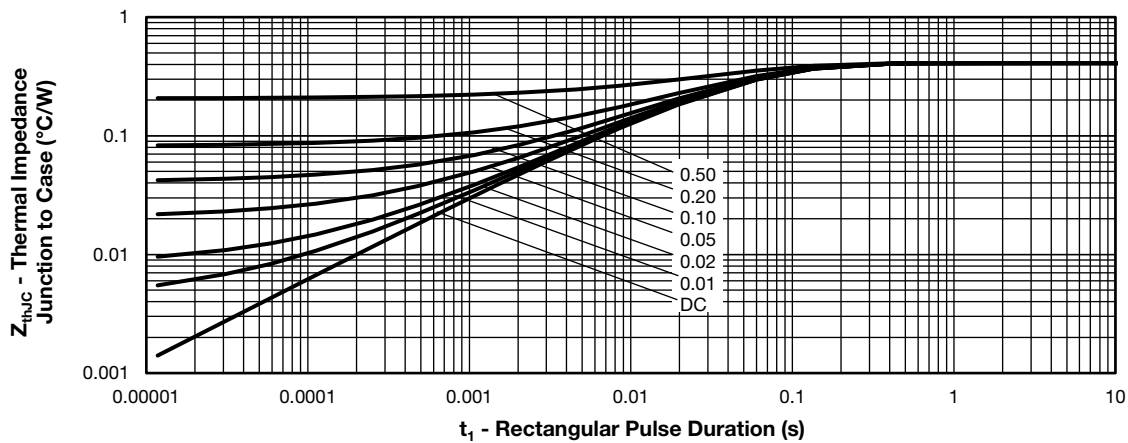
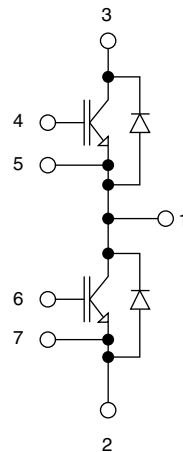

Fig. 20 - Maximum Antiparallel Diode Thermal Impedance  $Z_{thJC}$  Characteristics

**ORDERING INFORMATION TABLE**

Device code	<b>VS-</b>	<b>G</b>	<b>T</b>	<b>200</b>	<b>T</b>	<b>S</b>	<b>065</b>	<b>N</b>
	1	2	3	4	5	6	7	8

- 1** - Vishay Semiconductors product
- 2** - Insulated gate bipolar transistor (IGBT)
- 3** - T = trench IGBT
- 4** - Current rating (200 = 200 A)
- 5** - Circuit configuration (T = half bridge)
- 6** - Package indicator (S = INT-A-PAK IGBT)
- 7** - Voltage rating (065 = 650 V)
- 8** - Speed/type (N = ultrafast IGBT)

**CIRCUIT CONFIGURATION**



**DIMENSIONS** in millimeters

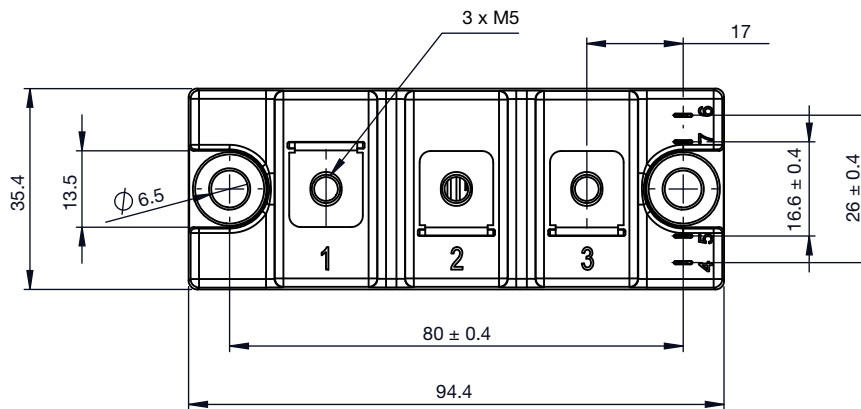
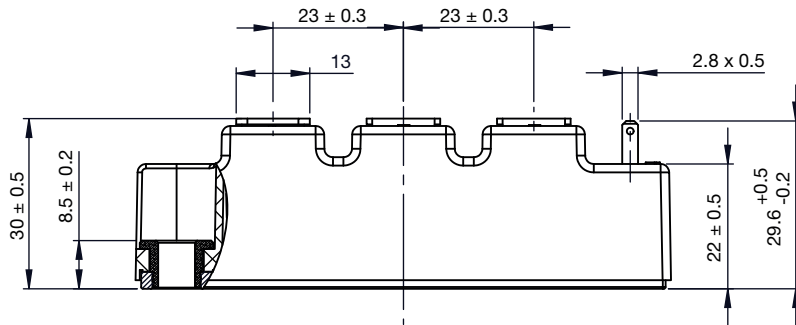

General tolerance  $\pm 0.5$  mm





## Disclaimer

ALL PRODUCT, PRODUCT SPECIFICATIONS AND DATA ARE SUBJECT TO CHANGE WITHOUT NOTICE TO IMPROVE RELIABILITY, FUNCTION OR DESIGN OR OTHERWISE.

Vishay Intertechnology, Inc., its affiliates, agents, and employees, and all persons acting on its or their behalf (collectively, "Vishay"), disclaim any and all liability for any errors, inaccuracies or incompleteness contained in any datasheet or in any other disclosure relating to any product.

Vishay makes no warranty, representation or guarantee regarding the suitability of the products for any particular purpose or the continuing production of any product. To the maximum extent permitted by applicable law, Vishay disclaims (i) any and all liability arising out of the application or use of any product, (ii) any and all liability, including without limitation special, consequential or incidental damages, and (iii) any and all implied warranties, including warranties of fitness for particular purpose, non-infringement and merchantability.

Statements regarding the suitability of products for certain types of applications are based on Vishay's knowledge of typical requirements that are often placed on Vishay products in generic applications. Such statements are not binding statements about the suitability of products for a particular application. It is the customer's responsibility to validate that a particular product with the properties described in the product specification is suitable for use in a particular application. Parameters provided in datasheets and / or specifications may vary in different applications and performance may vary over time. All operating parameters, including typical parameters, must be validated for each customer application by the customer's technical experts. Product specifications do not expand or otherwise modify Vishay's terms and conditions of purchase, including but not limited to the warranty expressed therein.

Hyperlinks included in this datasheet may direct users to third-party websites. These links are provided as a convenience and for informational purposes only. Inclusion of these hyperlinks does not constitute an endorsement or an approval by Vishay of any of the products, services or opinions of the corporation, organization or individual associated with the third-party website. Vishay disclaims any and all liability and bears no responsibility for the accuracy, legality or content of the third-party website or for that of subsequent links.

Except as expressly indicated in writing, Vishay products are not designed for use in medical, life-saving, or life-sustaining applications or for any other application in which the failure of the Vishay product could result in personal injury or death. Customers using or selling Vishay products not expressly indicated for use in such applications do so at their own risk. Please contact authorized Vishay personnel to obtain written terms and conditions regarding products designed for such applications.

No license, express or implied, by estoppel or otherwise, to any intellectual property rights is granted by this document or by any conduct of Vishay. Product names and markings noted herein may be trademarks of their respective owners.